

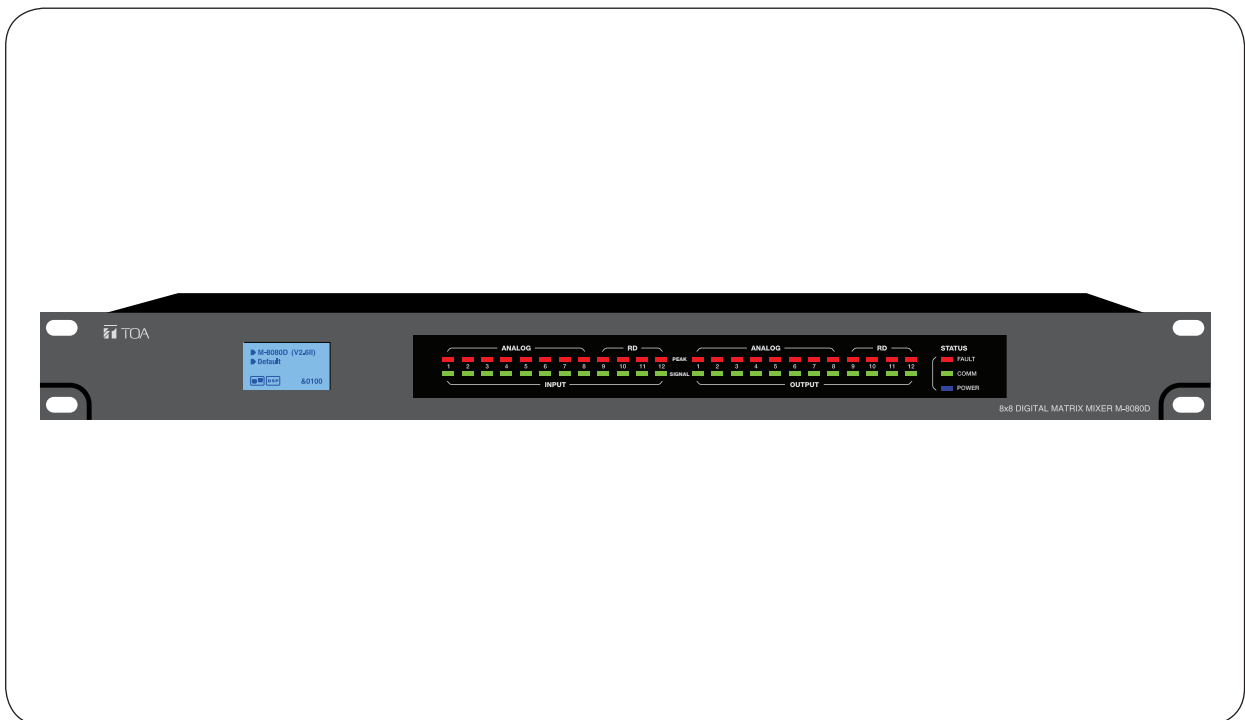

# OPERATING INSTRUCTIONS

## DIGITAL MATRIX MIXER SYSTEM M-8080D SERIES



Thank you for purchasing TOA's Digital Matrix Mixer System.  
Please carefully follow the instructions in this manual to ensure long, trouble-free use of your equipment.

TOA Corporation

## TABLE OF CONTENT

|   |    |
|---|----|
| <b>1. IMPORTANT SAFETY INSTRUCTIONS</b> .....                     | 3  |
| <b>2. INTRODUCTION</b> .....                                      | 6  |
| <b>3. MAIN FEATURES</b>   |    |
| 3.1. DIGITAL MATRIX.....  | 6  |
| 3.2. DSP FUNCTIONS.....   | 7  |
| 3.3. NETWORKS.....  | 7  |
| 3.4. DANTE NETWORKS.....  | 8  |
| <b>4. FRONT PANEL DESCRIPTION</b> .....                           | 9  |
| <b>5. REAR PANEL DESCRIPTION</b> .....                            | 10 |
| <b>6. M-8080D CONNECTION</b> .....                                | 12 |
| <b>7. DANTE INPUT CONFIGURE</b> .....                             | 16 |
| <b>8. SOFTWARE EDITOR</b>   |    |
| 8.1. INPUT DSP CHANNEL .....                                      | 17 |
| 8.2. OUTPUT DSP CHANNEL .....                                     | 19 |
| 8.3. MATRIX .....   | 20 |
| 8.4. DUCKER .....   | 21 |
| 8.5. FBC (FEEDBACK COMPRESSION) .....                             | 22 |
| 8.6. AUTO MIXER .....   | 24 |
| 8.7. SAVE / LOAD / COPY .....                                     | 25 |
| 8.8. SYSTEM .....   | 27 |
| <b>9. REMOTE DEVICES</b>  |    |
| 9.1. M-800RM .....  | 31 |
| 9.2. M-800RC .....  | 33 |
| 9.3. M-802RC .....  | 35 |
| 9.4. M-822IO .....  | 37 |
| 9.5. M-800RCT .....   | 38 |
| 9.6. M-804EX .....  | 42 |
| 9.7. M-800DT .....  | 42 |
| <b>10. APPLICATION EXAMPLES</b> .....                             | 43 |
| <b>11. RS-232 CODES</b> .....                                     | 47 |
| <b>12. SPECIFICATIONS</b>   |    |
| 12.1. 8x8 DIGITAL MATRIX MIXER M-8080D.....                       | 48 |
| 12.2. REMOTE MICROPHONE M-800RM.....                              | 49 |
| 12.3. REMOTE AUDIO CONTROL PANEL M-800RC.....                     | 50 |
| 12.4. REMOTE AUDIO CONTROL PANEL WITH AUDIO OUT M-802RC.....      | 50 |
| 12.5. REMOTE AUDIO INPUT OUTPUT PANEL M-822IO.....                | 51 |
| 12.6. REMOTE AUDIO CONTROL PANEL WITH TOUCH DISPLAY M-800RCT..... | 51 |
| 12.7. EXTENSION MODULE 4 PORTS M-804EX.....                       | 52 |
| 12.8. DANTE MODULE M-800DT.....                                   | 52 |
| <b>13. ARABIC IMPORTANT SAFETY INSTRUCTIONS</b> .....             | 53 |

# 1. IMPORTANT SAFETY INSTRUCTIONS

- Read these instructions.
- Keep these instructions.
- Heed all warnings.
- Follow all instructions.
- Do not use this apparatus near water.
- Clean only with dry cloth.
- Do not block any ventilation openings. Install in accordance with the manufacturer's instructions.
- Do not install near any heat sources such as radiators, heat registers, stoves, or other apparatus (including amplifiers) that produce heat.
- Do not defeat the safety purpose of the polarized or grounding-type plug. A grounding type plug has two blades and a third grounding prong. If the provided plug does not fit into your outlet, consult an electrician for replacement of the obsolete outlet.
- Protect the power cord from being walked on or pinched particularly at plugs, convenience receptacles, and the point where they exit from the apparatus.
- Only use attachments/accessories specified by the manufacturer.
- Use only with the cart, stand, tripod, bracket, or table specified by the manufacturer, or sold with the apparatus. When a cart is used, use caution when moving the cart/apparatus combination to avoid injury from tip-over.



- Unplug this apparatus during lightning storms or when unused for long periods of time.
- Refer all servicing to qualified service personnel. Servicing is required when the apparatus has been damaged in any way, such as power-supply cord or plug is damaged, liquid has been spilled or objects have fallen into the apparatus, the apparatus has been exposed to rain or moisture, does not operate normally, or has been dropped.

## INSTRUCTIONS ESSENTIELLES POUR LA SÉCURITÉ

- Lire ces instructions.
- Conserver ces instructions pour référence ultérieure.
- Respecter tous les avertissements.
- Suivre toutes les instructions.
- Ne pas utiliser cet appareil à proximité d'eau.
- Nettoyer uniquement à l'aide d'un chiffon sec.
- Ne pas obstruer les orifices de ventilation. Installer conformément aux instructions du fabricant.
- Ne pas installer à proximité de sources de chaleur telles que des radiateurs, des registres thermiques, des chaudières ou d'autres appareils (notamment des amplificateurs) produisant de la chaleur.
- Ne pas contourner la fonction de sécurité de la fiche polarisée ou de mise à la terre. Une fiche de mise à la terre est équipée de deux broches et d'une troisième pour la mise à la terre. Si la fiche fournie ne peut être insérée dans la prise électrique souhaitée, consulter un électricien pour faire remplacer cette dernière.
- Protéger le cordon d'alimentation pour éviter qu'il ne soit piétiné ou pincé, notamment au niveau des fiches, des prises de courant ou de son point de sortie de l'appareil.
- Utiliser uniquement les accessoires spécifiés par le fabricant.
- Utiliser uniquement avec le chariot, support, trépied, la patte de montage ou la table spécifiés par le fabricant ou vendus avec l'appareil. En cas d'utilisation d'un chariot, manipuler la combinaison chariot/appareil pour éviter les blessures dues à un renversement.



- Débrancher cet appareil pendant les orages ainsi que lorsqu'il reste inutilisé pendant une période prolongée.
- La maintenance de l'appareil doit être confiée à un technicien après-vente qualifié. Une maintenance s'avère nécessaire si l'appareil est endommagé (au niveau du cordon d'alimentation ou de la fiche), a été mouillé par un liquide, un objet est tombé à l'intérieur, s'il a été exposé à la pluie ou l'humidité, s'il ne fonctionne pas normalement ou s'il est tombé.

## SAFETY PRECAUTIONS

- Before installation or use, be sure to carefully read all the instructions in this section for correct and safe operation.
- Be sure to follow all the precautionary instructions in this section, which contain important warnings and/or cautions regarding safety.
- After reading, keep this manual handy for future reference.

### Safety Symbol and Message Conventions

Safety symbols and messages described below are used in this manual to prevent bodily injury and property damage which could result from mishandling. Before operating your product, read this manual first and understand the safety symbols and messages so you are thoroughly aware of the potential safety hazards.



The exclamation point within an equilateral triangle is intended to alert the user to the presence of important operation and maintenance (servicing) instruction in the literature accompanying the appliance.



Le point d'exclamation à l'intérieur d'un triangle équilatéral avertit l'utilisateur de l'existence d'instructions d'utilisation et d'entretien (réparation) dans la documentation fournie avec l'appareil.



### **WARNING**

Indicates a potentially hazardous situation which, if mishandled, could result in death or serious personal injury.

#### When Installing the Unit

- **WARNING:** Do not expose the unit to rain or an environment where it may be splashed by water or other liquids, as doing so may result in fire or electric shock.
- Use the unit only with the voltage specified on the unit. Using a voltage higher than that which is specified may result in fire or electric shock.
- Do not cut, kink, otherwise damage nor modify the power supply cord. In addition, avoid using the power cord in close proximity to heaters, and never place heavy objects -- including the unit itself -- on the power cord, as doing so may result in fire or electric shock.
- Avoid installing or mounting the unit in unstable locations, such as on a rickety table or a slanted surface. Doing so may result in the unit falling down and causing personal injury and/or property damage.
- External wiring connected to the terminals marked with  requires installation by an instructed person.
- The apparatus shall be connected to a mains socket outlet with a protective earthing connection.
- L'appareil doit être branché à une prise d'alimentation avec mise à la terre de protection.
- The socket-outlet shall be installed near the equipment and the plug (disconnecting device) shall be easily accessible.
- The unit is not suitable for use in locations where children are likely to be present.

#### When the Unit is in Use

- Should the following irregularity be found during use, immediately switch off the power, disconnect the power supply plug from the AC outlet and contact your nearest TOA dealer. Make no further attempt to operate the unit in this condition as this may cause fire or electric shock.
  - If you detect smoke or a strange smell coming from the unit
  - If water or any metallic object gets into the unit
  - If the unit falls, or the unit case breaks
  - If the power supply cord is damaged (exposure of the core, disconnection, etc.)
  - If it is malfunctioning (no tone sounds.)
- To prevent a fire or electric shock, never open nor remove the unit case as there are high voltage components inside the unit. Refer all servicing to your nearest TOA dealer.
- Do not place cups, bowls, or other containers of liquid or metallic objects on top of the unit. If they accidentally spill into the unit, this may cause a fire or electric shock.
- Do not insert nor drop metallic objects or flammable materials in the ventilation slots of the unit's cover, as this may result in fire or electric shock.



## **WARNING**

Indicates a potentially hazardous situation which, if mishandled, could result in moderate or minor personal injury, and/or property damage.

### **When Installing the Unit**

- Never plug in nor remove the power supply plug with wet hands, as doing so may cause electric shock.
- When unplugging the power supply cord, be sure to grasp the power supply plug; never pull on the cord itself. Operating the unit with a damaged power supply cord may cause a fire or electric shock.
- When moving the unit, be sure to remove its power supply cord from the wall outlet. Moving the unit with the power cord connected to the outlet may cause damage to the power cord, resulting in fire or electric shock. When removing the power cord, be sure to hold its plug to pull.
- Do not block the ventilation slots in the unit's cover. Doing so may cause heat to build up inside the unit and result in fire.
- Avoid installing the unit in humid or dusty locations, in locations exposed to the direct sunlight, near the heaters, or in locations generating sooty smoke or steam as doing otherwise may result in fire or electric shock.
- To avoid electric shocks, be sure to unplug the unit's power supply cord when connecting speakers.
- Be sure to follow the instructions below when rack-mounting the unit. Failure to do so may cause a fire or personal injury.
  - Install the equipment rack on a stable, hard floor. Fix it with anchor bolts or take other arrangements to prevent it from falling down.
  - When connecting the unit's power cord to an AC outlet, use the AC outlet with current capacity allowable to the unit.
  - No rack-mounting screws are supplied with the unit. Separately prepare the appropriate screws for the rack.

### **When the Unit is in Use**

- Do not place heavy objects on the unit as this may cause it to fall or break which may result in personal injury and/or property damage. In addition, the object itself may fall off and cause injury and/or damage.
- Make sure that the volume control is set to minimum position before power is switched on. Loud noise produced at high volume when power is switched on can impair hearing.
- Do not operate the unit for an extended period of time with the sound distorting. This is an indication of a malfunction, which in turn can cause heat to generate and result in a fire.
- If dust accumulates on the power supply plug or in the wall AC outlet, a fire may result. Clean it periodically. In addition, insert the plug in the wall outlet securely.
- Switch off the power, and unplug the power supply plug from the AC outlet for safety purposes when cleaning or leaving the unit unused for 10 days or more. Doing otherwise may cause a fire or electric shock.



The lightning flash with arrowhead symbol, within an equilateral triangle, is intended to alert the user to the presence of uninsulated "dangerous voltage" within the product's enclosure that may be of sufficient magnitude to constitute a risk of electric shock to persons.



L'éclair accompagné d'un symbole représentant une pointe de flèche à l'intérieur d'un triangle équilatéral avertit l'utilisateur de la présence d'une "tension dangereuse" à l'intérieur de l'enceinte du téléviseur, dont la magnitude peut être suffisante pour constituer un risque de choc électrique pour les personnes.



## **ATTENTION**

L'appareil ne doit pas être exposé aux éclaboussures ou écoulements et tous objets remplis de liquide, tels que vases, ne doivent pas être sur l'appareil.

## 2. INTRODUCTION

Thank you for purchasing the M-8080D series Digital Matrix Mixer System. This device is dedicated to music, paging, discussion and zone management solutions for Commercial Audio applications. Easy to use and to implement, M-8080D offers state-of-the-art signal processing in a cost effective package.

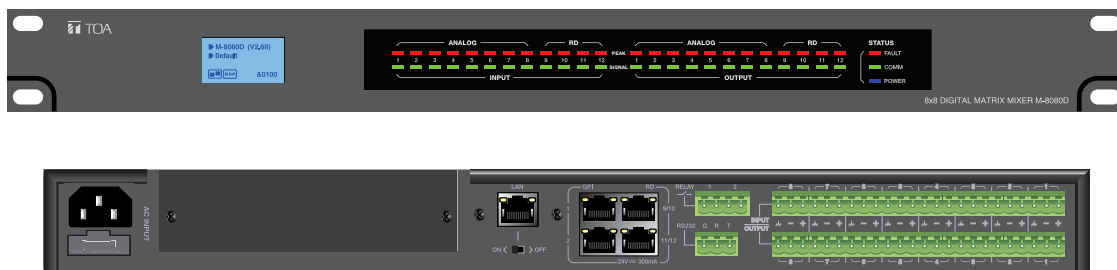

M-8080D is a DIGITAL AUDIO PLATFORM for professional use. It can be used in following electromagnetic environments: residential, commercial and light industries and urban outdoors. The apparatus is intended for rack mounting.

## 3. MAIN FEATURES

### 3.1. DIGITAL MATRIX

Projects using DSP platforms usually require a minimum number of inputs and outputs. This determines the choice of dedicated matrix models. M-8080D offers a large choice of IN/OUT options in order to cover most of applications:

#### Stand-alone system audio IN/OUT:

- Standard: 8 analogue IN / 8 analogue OUT on rear panel ports of **M-8080D**.
- Optional: 4 digital IN / 4 digital OUT via remote devices.
- Maximum system IN/OUT: 12 x 12.

Optional remote devices with Audio IN/OUT. Consumption on Audio IN/OUT from devices in regards to additional available 4 digital IN / 4 digital OUT per **M-8080D**.

| Remote devices | Audio IN | Audio OUT |
|----------------|----------|-----------|
| M-800RM        | 2x       | --        |
| M-802RC        | --       | 2x        |
| M-822IO        | 2x       | 2x        |

Note:

- Only 2x **M-800RM/M-802RC/M-822IO** can be connected physically to 1x **M-8080D** (available ports).
- 12x12 can be realized by using 2x **M-822IO**.
- Internal A/D conversion sampling rate 48kHz, Bit rate 24 bits.

#### Dante system audio IN/OUT:

After installing the M-800DT Dante module in a stand-alone system, it can be interconnected via Dante network. A maximum of 16 x stand-alone system can be connected through the Dante network, with a maximum of 192 inputs and 192 outputs.

Please refer to item 3.4 on page 8.

\*Dante® is a registered trademark of Audinate Pty Ltd.

### 3.2. DSP FUNCTIONS

M-8080D is intended for non-experts. The system used fix architecture for quick and easy operation. The intuitive GUI utilizes a familiar hardware-like layout to enable a short programming timeline and rapid hardware implementation.

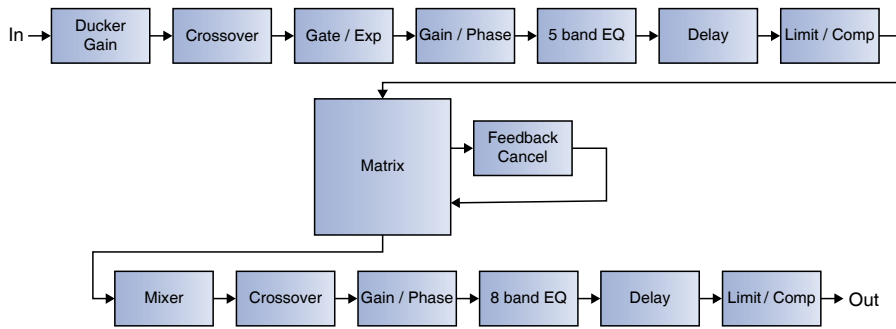

All functions can be configured with the PC Editor Software. Settings can be memorized for easy duplication or modification:

### 3.3. NETWORKS

**M-8080D** uses two types of network connections:

- **RD**, based on RS-485 for panel control and AES3 for digital audio transport.
- **TCP/IP** for LAN control.

#### Cable connections for Remote Controllers (RD ports)

Use shielded CAT 5e (or better) cable to connect the remote controllers to the RD ports. The maximum transmission distance is **100 meters**. If wall-mounted controllers can be connected to the ground (except the Paging Station), the distance can be increased up to 150 meters.

**⚠ CAUTION** Never connect a RD port to the router, this can cause damage to the devices.

The port can transmit and receive AES3 plus control signal, the following graphic illustrates the termination and also shows function of each wire pair on the network:

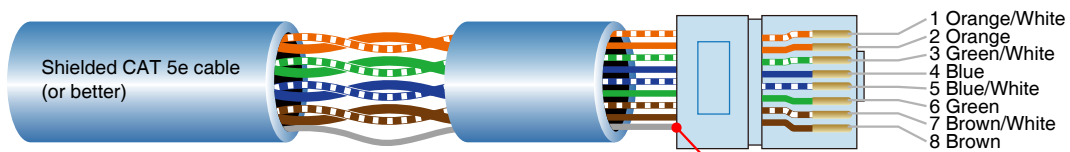

**Note:** The braid screen or foil of the shielded cable must be securely connected to the metal shell of the shielded RJ45 connector.

The green pair is reserved for data communications between **M-8080D** and remote device. Data communication is needed to send configuration information, software update and status information from **M-8080D** to remote device.

Note: Configuration information of remote device (such LED illuminate status, microphone sensitivity, channel name, etc.) is stored in **M-8080D**, not in the remote devices. This makes easy to swap for a new remote device without losing the configured information.

The orange and blue pairs carry two channels each of balanced differential AES3 digital audio. **TX** refers to audio that the remote device sends to **M-8080D**, **RX** refers to audio that remote device receives from **M-8080D**.

The brown pair provides 24VDC power and ground for the remote device.

Pins meaning of RD port:

|             |             |                |
|-------------|-------------|----------------|
| 1- AES TX + | 5- RS485 RX | CASE- SHIELDED |
| 2- AES TX-  | 6- AES RX-  |                |
| 3- AES RX+  | 7- DC24V    |                |
| 4- RS485 TX | 8- GND      |                |

#### Cable connections for TCP/IP (LAN port)

M-8080D and the PC should use the internal LAN of the router, the router + PC should work with DHCP function.

At the moment, all must be connected to a network router by shielded CAT 5e (or better) cable.

**ENVIRONMENT:**

The M-8080D can be programmed by using the software editor available with the device. It works with Windows 7 and above.

\*Windows is a trademark of Microsoft Corporation.

**Connection Example:**

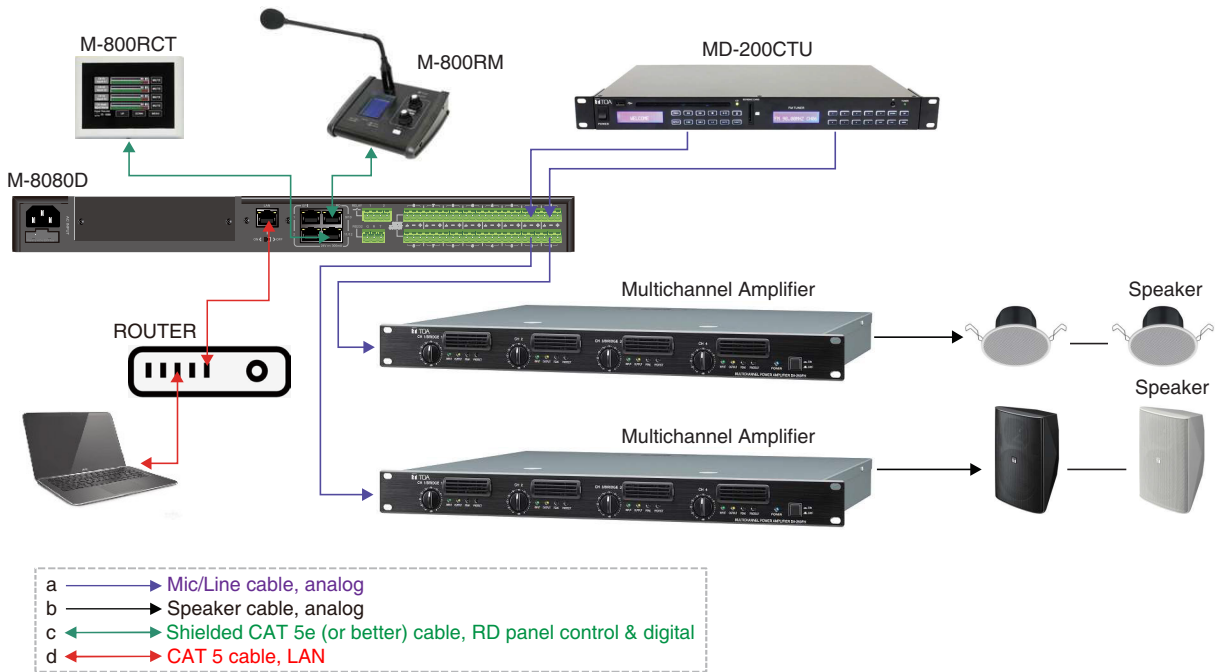

**3.4. DANTE NETWORK**

The **M-8080D** can communication through the Dante network after installing the **M-800DT** Dante module.

Dante network usage for cascading TOA's **M-8080D**.

When the network bandwidth is 100Mbps, 2 x **M-8080Ds** can be connected at most.

When the network bandwidth is 1000Mbps, 16 x **M-8080Ds** can be connected at most.

Use CAT 6 and above cable for connections, the maximum cable length is **100 meters**.

Dante is not capable of transmitting updates.

\*Dante® is a registered trademark of Audinate Pty Ltd.

**Connection Example:**

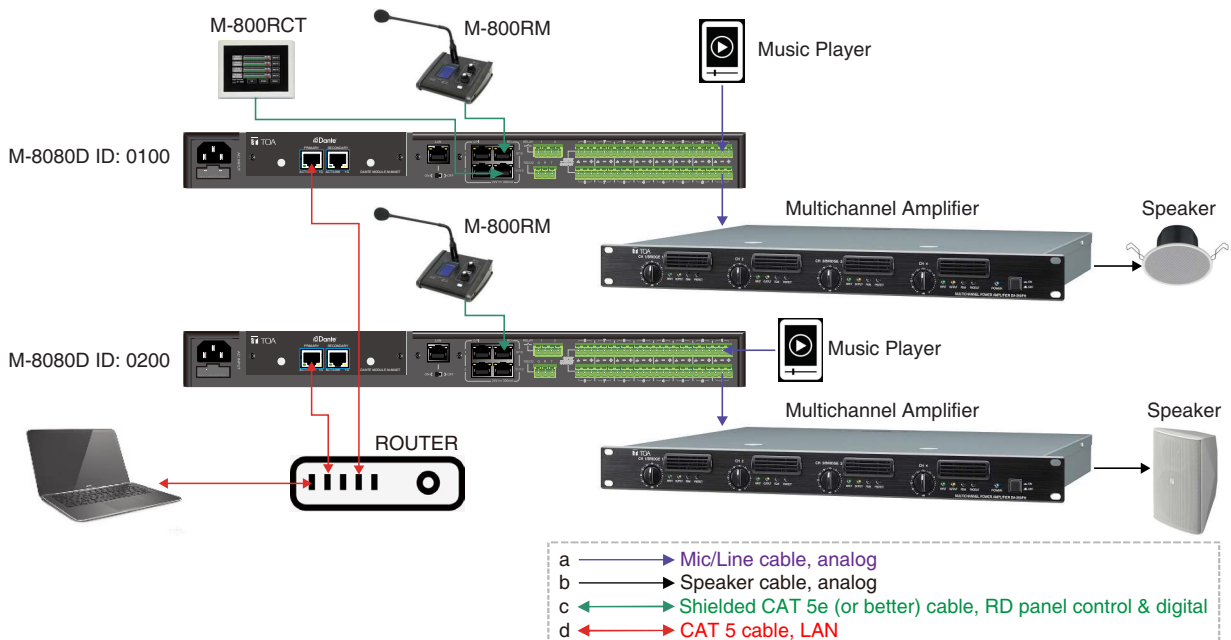

## 4. FRONT PANEL DESCRIPTION

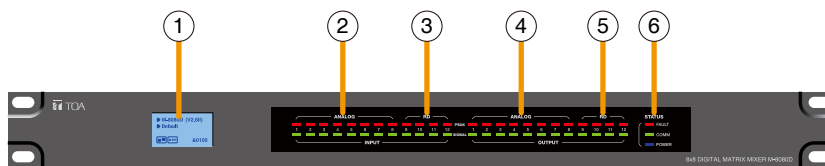

### 1. LC-Display

It displays device information. Such as name, firmware and ID, and communication status.

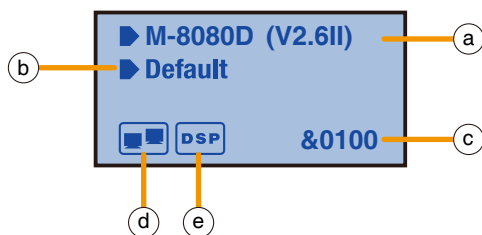

- a. Displays device name and the firmware version.
- b. It displays the current preset.
- c. Current ID. The ID is automatically obtained when the device is correctly connected. ID&0100
- d. Connection indicator between the PC and the device. If the connection is Okay.  
Both icons in the box will flash alternately.
- e. DSP connection indicator. In case of problem “**DSP!**” will be displayed.

### 2. ANALOG

Analog input indicators. The Green LED indicates presence of signal, the Red LED indicates signal clipping of the corresponding input.

### 3. RD

RD digital input indicators. The Green LED indicates presence of signal, the Red LED indicates signal clipping of the corresponding input.

### 4. ANALOG

Analog output indicators. The Green LED indicates presence of signal, the Red LED indicates signal clipping of the corresponding output.

### 5. RD

RD digital output indicators. The Green LED indicates presence of signal, the Red LED indicates signal clipping of the corresponding output.

### 6. STATUS

- **FAULT**: Red LED indicating a malfunction of the DSP. The information is relayed on the LC-Display.
- **COMM**: Green LED indicating the communication status between the PC and the device. The LED blinks during data transfer. It remains off in case of problems.
- **POWER**: Blue LED indicating that the unit is powered.

## 5. REAR PANEL DESCRIPTION

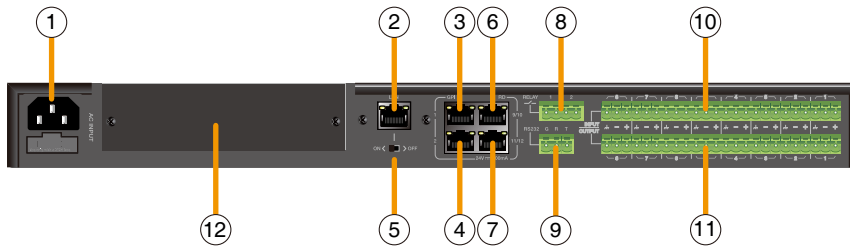

### 1. Power Socket

The power socket must be used with accessory cord.

The supply voltage is between 100 V and 240 VAC, 50-60 Hz, depending on countries.

The socket includes the fuse compartment. When changing it, make sure to replace it with a model of the same characteristics.

Fuse: T1.6AL AC250V

### 2. LAN

Port for the Ethernet connection, 10/100/1000Mbps adaptive, with DHCP function. The plug includes two LEDs, a green one indicating the good connection to the network and a yellow one indicating the good data transmission.

- If the yellow LED turns Off, there is a transmission problem. If On, with Green LED Off, the device has detected the network, but there is no connection.
- If the Green LED is on, the network connection is correct.

### 3. GPI 1 Port

This function is used to control the input / output priority / mute all outputs of channels 1-8, the details please see page 28.

### 4. GPI 2 Port

The function of this port is the same as that of GPI 1, the details please see page 28.

**Note:** The open voltage of GPI is 1.5V, and the open resistance is 200Ω. It is only used for relay or switch control.

### 5. ON/OFF SW

Switch on assign Ethernet to the LAN port .

### 6. RD 9/10

RD Port to connect remote device accessory such as **M-822IO**, **M-802RC**, **M-800RM**, **M-800RC**, **M-800RCT** and **M-804EX**.

This port transmits and receives AES3 digital audio plus control data.

**M-822IO** for instance, includes A/D and D/A converters for two IN/OUT assigned to channels 9 and 10.

### 7. RD 11/12

Similar to port RD 9/10 (6) but assigned to channels 11 and 12.

### About M-8080D RD port expansion:

Can use **M-804EX** / **M-800RCT** / **M-800RC** to expand the RD port of M-8080D.

Each **M-8080D** RD port can support up to 1pc **M-804EX** or 4pcs **M-800RCT** / **M-800RC**.

**Note:** 1x **M-804EX** can be added exclusively.

### Application Examples

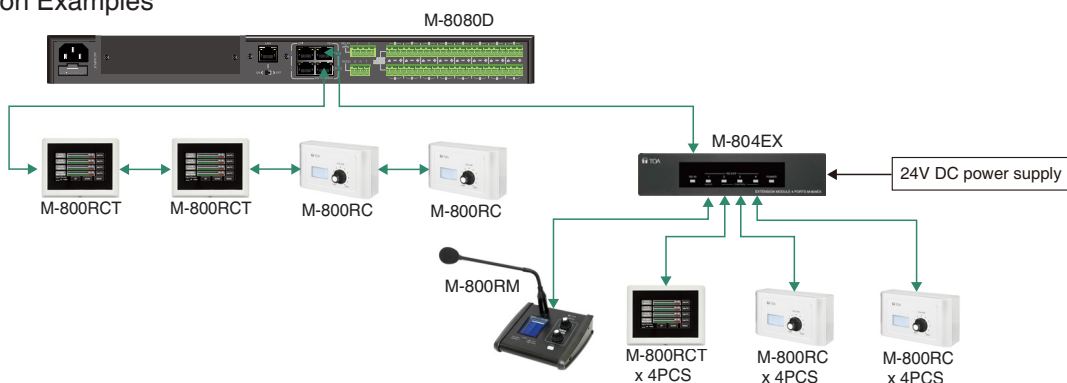

**Important**

Be sure to switch off the unit's power when connecting or removing the device. Failure to do so may cause the device to fail.

The braid screen or foil of the shielded CAT 5e cable must be securely connected to the metal shell of the shielded RJ45 connector.

**8. RELAY**

Dry contacts where ON/OFF status can be individually controlled in the System menu (Please refer to page 27).

They are generally used as switches for third party electrical equipment.

**Attention:** withstand voltage: 24V DC, control current: Under 500mA.

**9. RS-232**

This interface is used to remotely control **M-8080D** parameters, such as a Preset change or a modification of the gain for one channel.

Please refer to Appendix page 40 to consult the code table.

RS-232 wire connection diagram

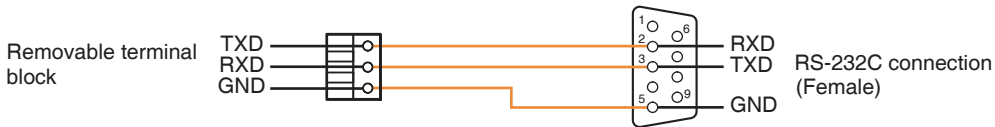

**10. INPUT**

Euroblock connector including 8 balanced analog inputs.

**11. OUTPUT**

Euroblock connector including 8 balanced analog outputs.

**12. DANTE MODULE INPUT PORT**

This location is reserved for the optional Dante module **M-800DT**.

**Dante module M-800DT installation**

- a. Remove the 2 screws on the Dante module input port cover and remove the cover.
- b. Plug the module fully into the input port by sliding them along the left and right guide rails, then secure with two screws.

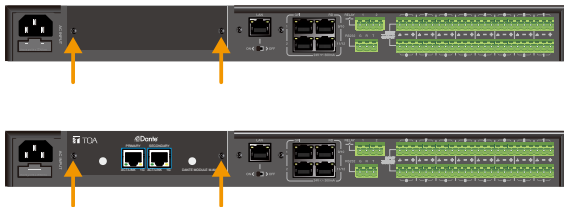

**Important**

Be sure to switch off the unit's power when inserting or removing the module. Failure to do so may cause the module to fail.

## 6. M-8080D CONNECTION

### Standalone System

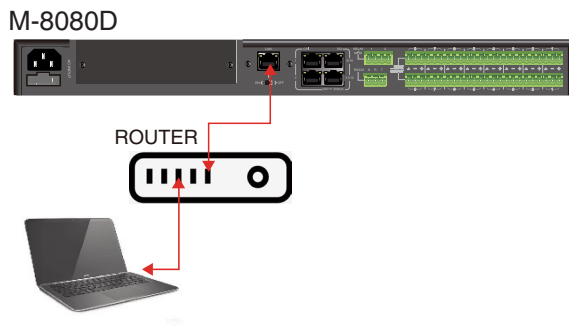

### Software Function Introduction

Once the connection is completed. Open the **M-8080D** System Control Editor. The initial page shows as below:

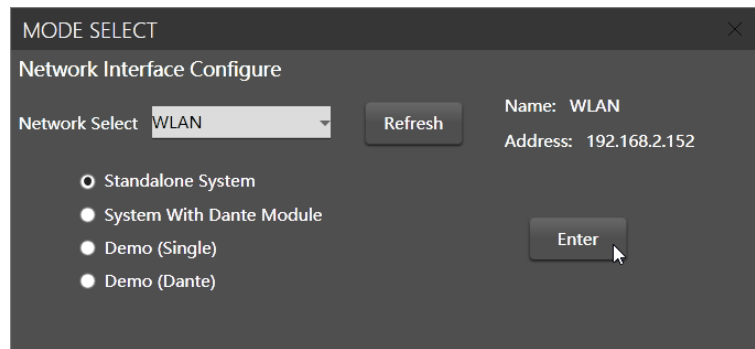

Click Enter to open the software.

#### Attention:

- 1) After firmware is updated, the machine will automatically restart. After temporarily changing the router, it is recommended to restart the PC control software.
- 2) Regarding the IP address connection, it should use the internal LAN of the router, the router + PC should work with DHCP function.

### 1. System Introduction

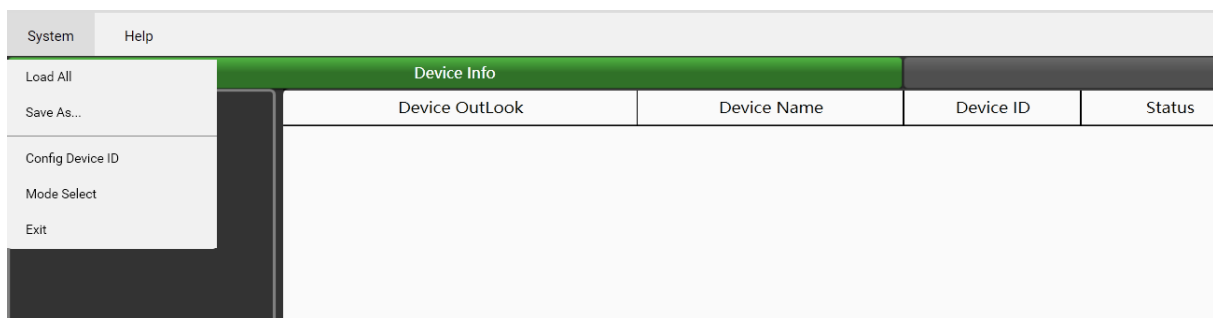

**Load All:** Load the device configuration file (except the preset list data).

**Save As:** Save the current device configuration data to local (except the preset list data).

**Config Device ID:** ID must be 0100.

**Mode Select:** Return to the "MODE SELECT" window.

**Exit:** Quit the software.

**Note:** The Preset which was active before power off will be reloaded when power on the device.

## 2. Add Device Introduction

Click "Scan", the system will automatically search for all online devices and appear in the matrix system list.

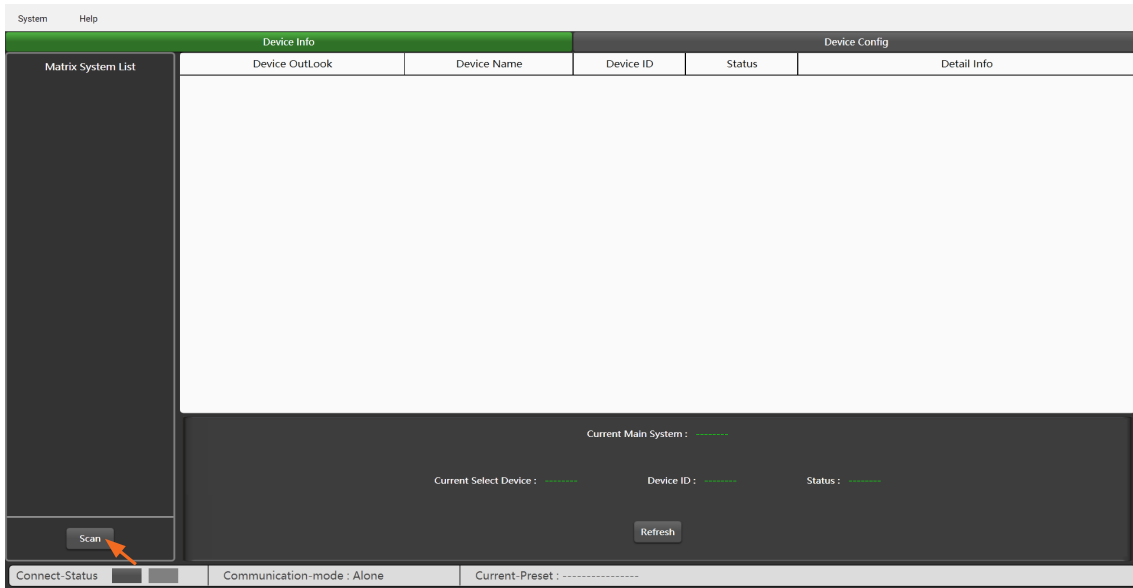

Click the found matrix system, and select "Yes" in the pop-up window to connect to this system.

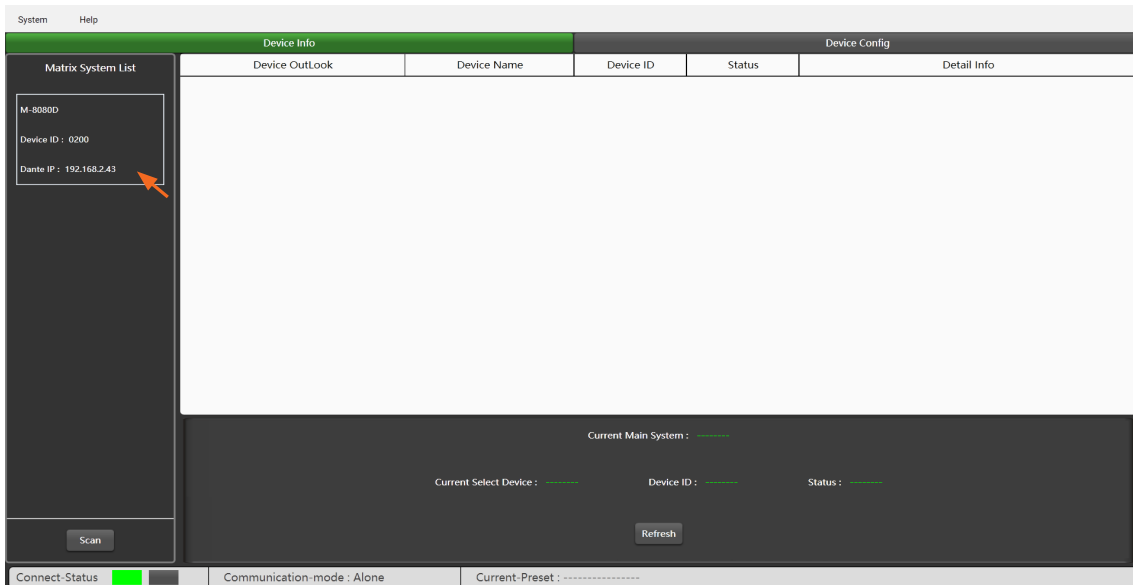

**Refresh:** Refresh the current online status of the device.

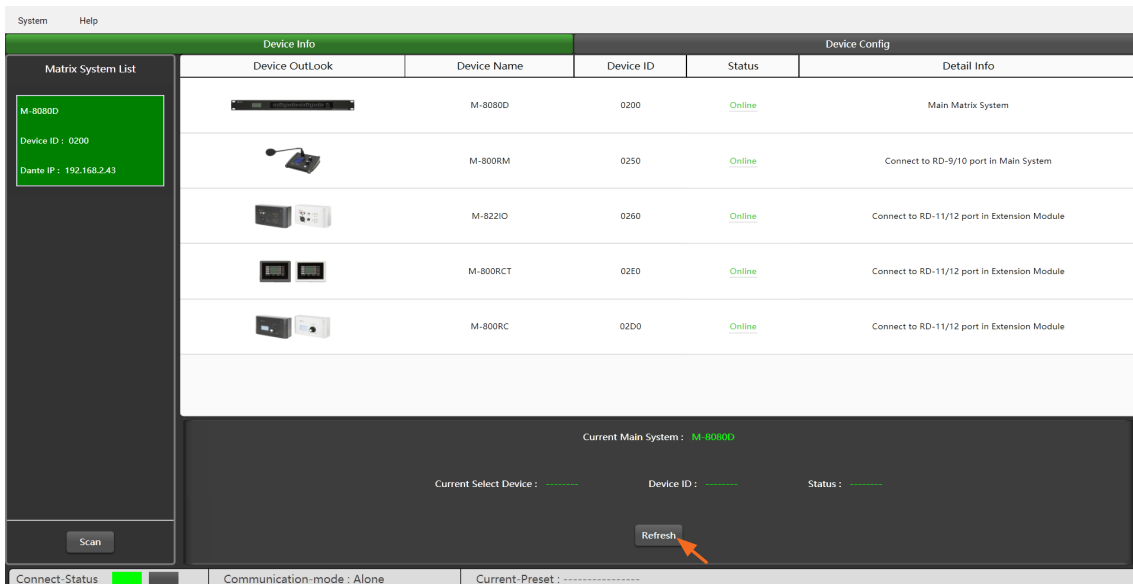

## System With Dante Module

(M-8080D can only be enabled after the Dante module M-800DT is installed.)

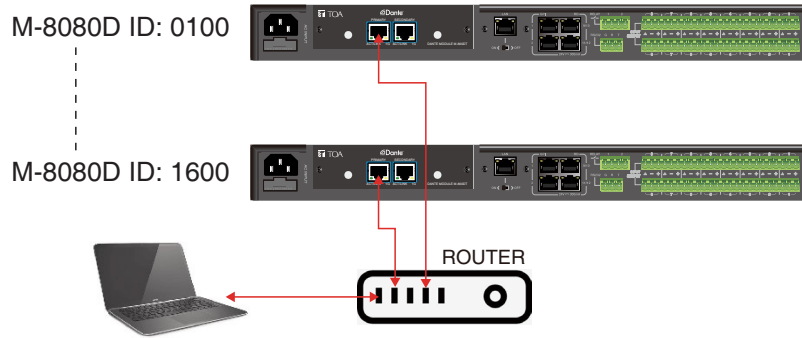

### Note:

When the network bandwidth is 100Mbps, 2 x M-8080Ds can be connected at most.

When the network bandwidth is 1000Mbps, 16 x M-8080Ds can be connected at most.

## Software Function Introduction

Once the connection is completed. Open the M-8080D System Control Editor. The initial page shows as below:

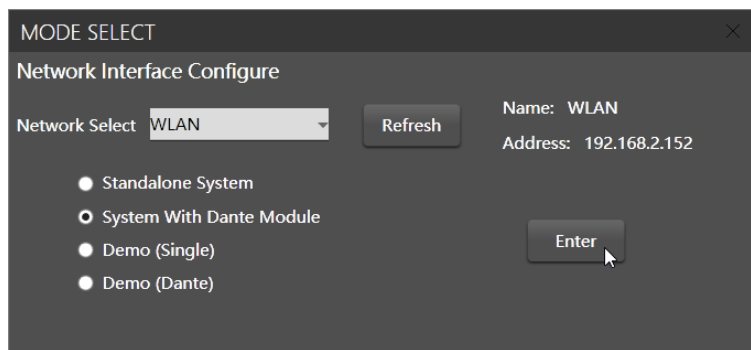

Click Enter to open the software.

### Attention:

1) After firmware is updated, the machine will automatically restart. After temporarily changing the router, it is recommended to restart the PC control software.

2) Regarding the IP address connection, it should use the internal LAN of the router, the router + PC should work with DHCP function.

## 1. System Introduction

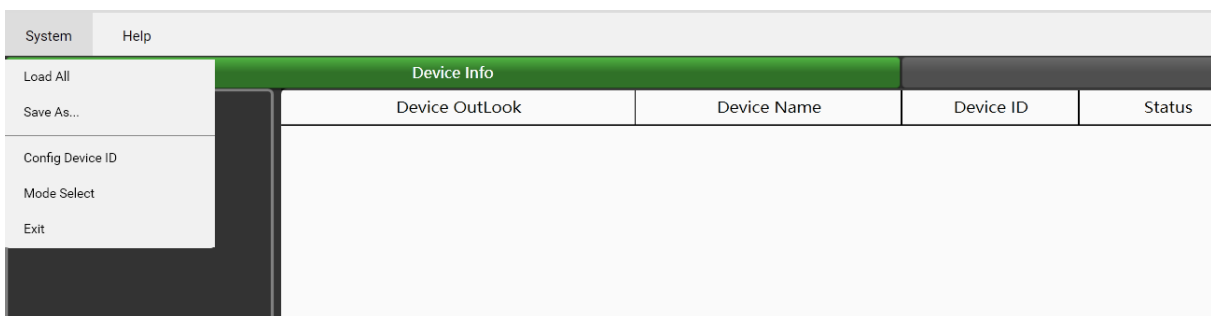

**Load All:** Load the device configuration file(except the preset list data and the Dante input configuration data).

**Save As:** Save the current device configuration data to local (except the preset list data and the Dante input configuration data).

**Config Device ID:** Customize device ID, the ID can be modified in the range of 0100, 0200, 0300...1600.

**Mode Select:** Return to the "MODE SELECT" window.

**Exit:** Quit the software.

**Note:** The Preset which was active before power off will be reloaded when power on the device.

## 2. Add Device Introduction

Click "Scan", the system will automatically search for all online devices and appear in the matrix system list.

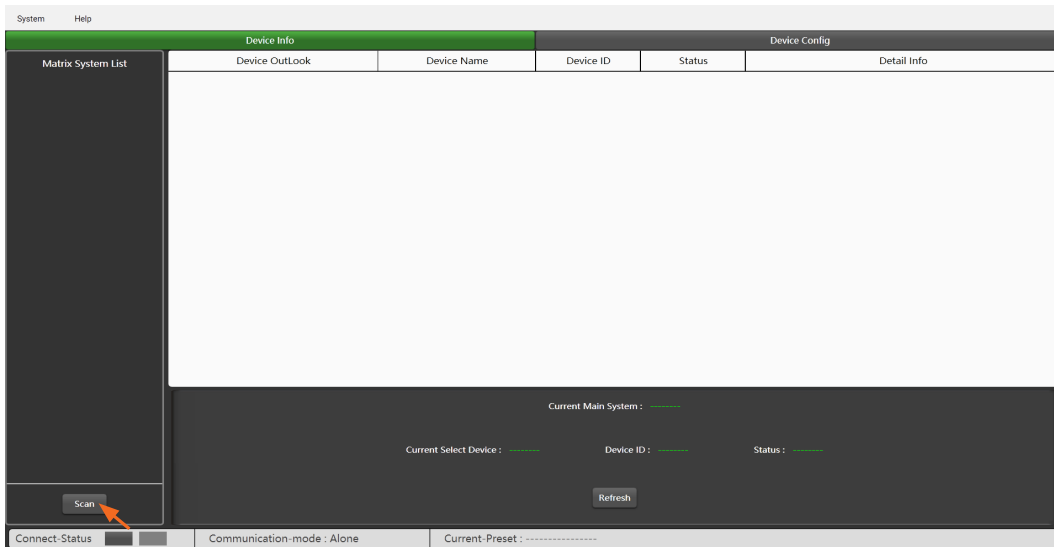

Click the desired matrix system, and select "Yes" in the pop-up window to connect to this system.

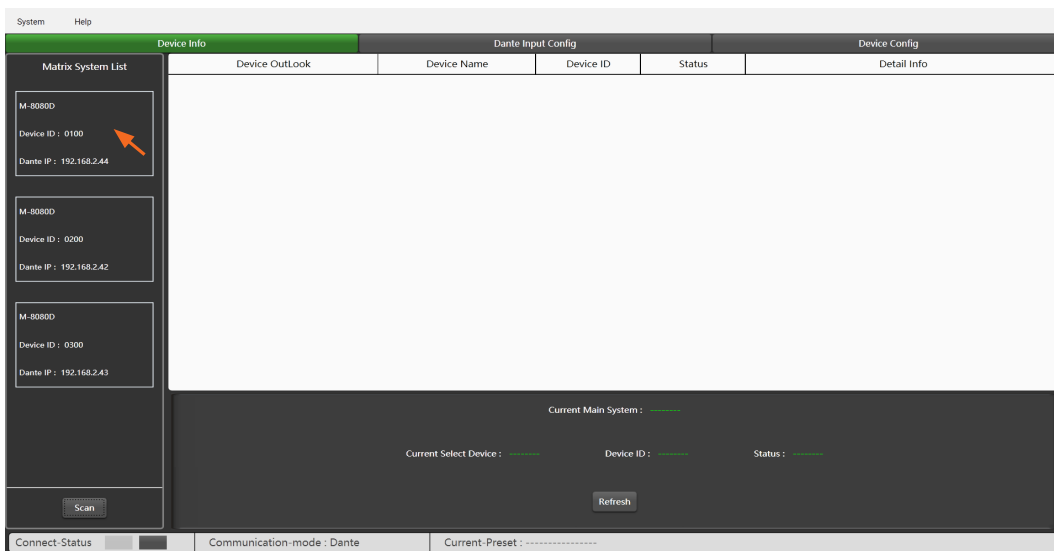

**Refresh:** Refresh the current online status of the device.

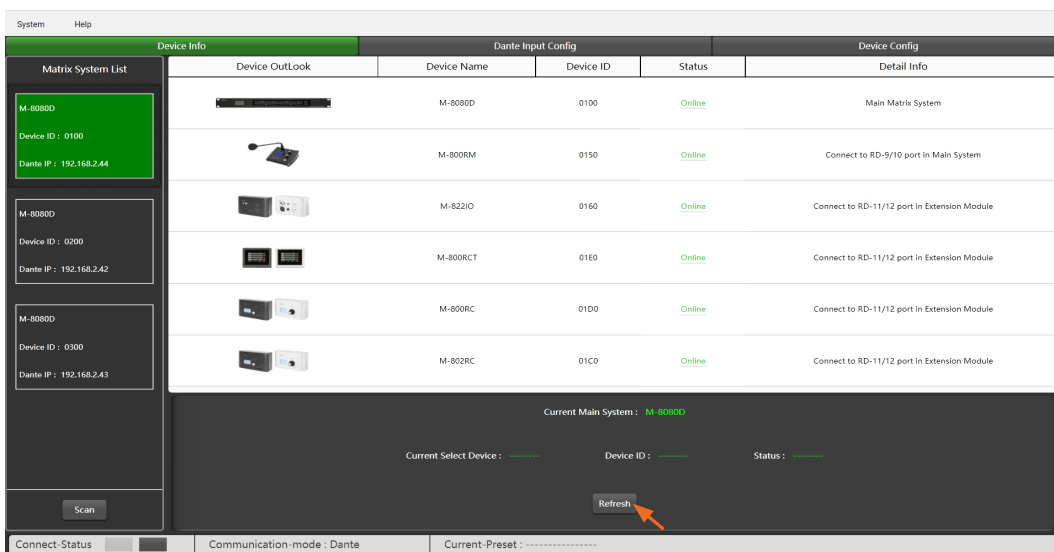

**Note:**

The device information shows the information for the highlighted device. It remains even after switching the main device.

## 7. DANTE INPUT CONFIGURE

(Configuration is only required if the Dante module M-800DT is installed and the "System with Dante module" mode is selected.)

Click "Dante Input Config" page to enter the configuration.

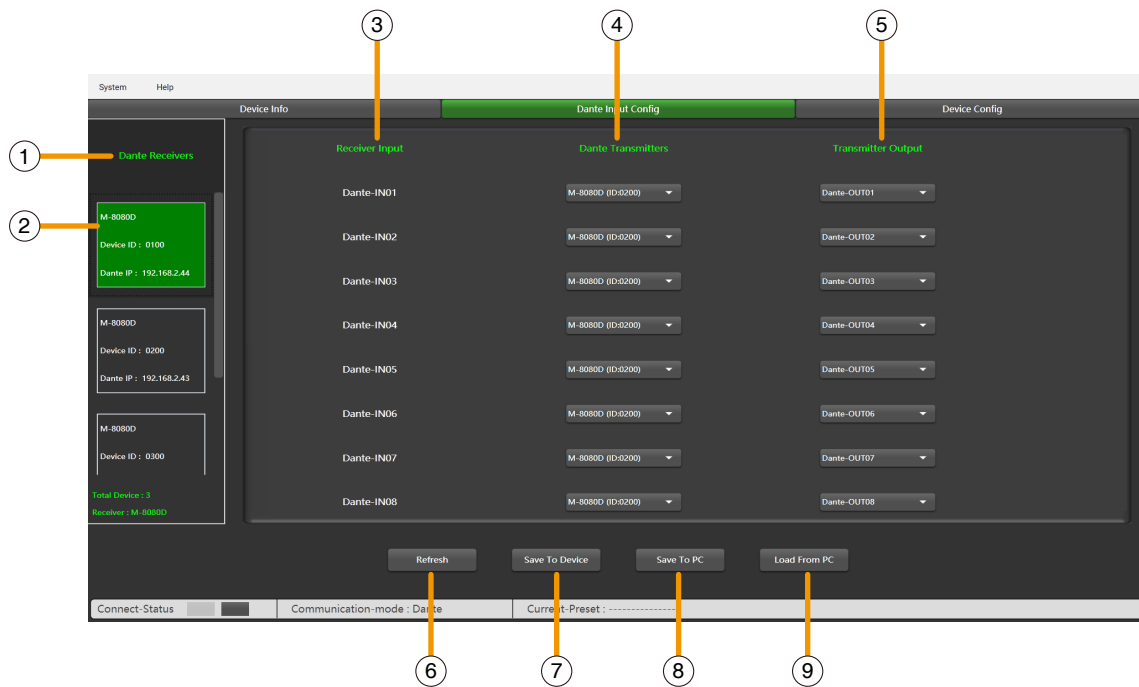

1. **Dante Receivers:** All online Dante devices are displayed below.
2. **Dante device in configuration:** The background color is green, and the configuration items is displayed on the right.
3. **Receiver Input:** There are a total of 8 Dante input channels.
4. **Dante Transmitters:** Select the ID number of the Dante transmitter **M-8080D**.
5. **Transmitter Output:** When the ID number of the Dante transmitter **M-8080D** is selected, one of the output channels from that transmitter is selected for communication.
6. **Refresh:** Load the settings of the Dante input from the device.
7. **Save To Device:** Save the settings of the Dante input to the device.
8. **Save To PC:** Save current settings of the Dante input to PC.
9. **Load From PC:** Load the settings of the Dante input from PC.

### Function Example:

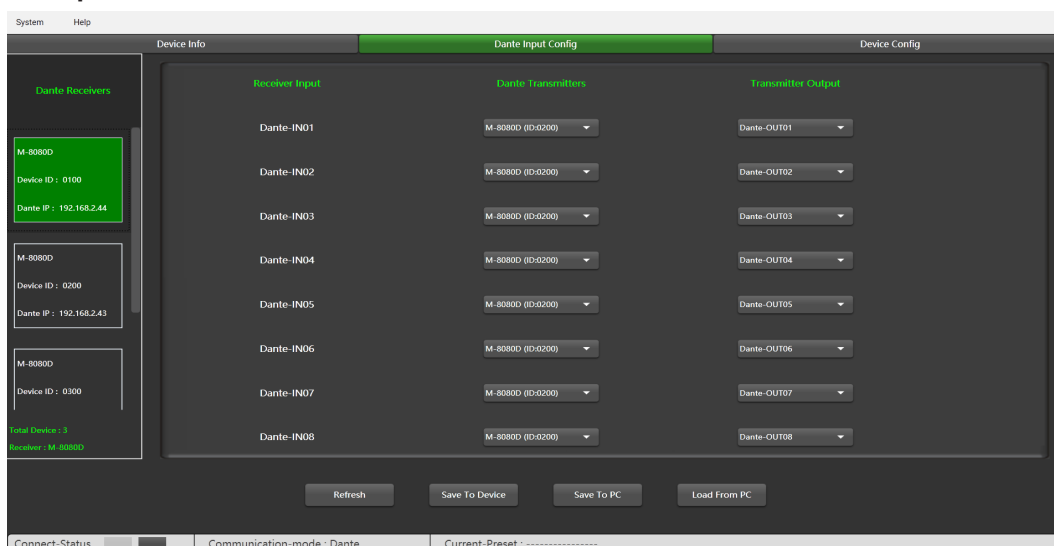

The Dante-IN01 of the M-8080D (ID:0100) receives audio signals from the Dante-OUT01 of the M-8080D (ID:0200).

## 8. SOFTWARE EDITOR

Click "Device Config" page to enter the configuration.

### 8.1. INPUT DSP CHANNEL

On the "DSP channel" page, click the input channel name to enter the corresponding input channel DSP settings.

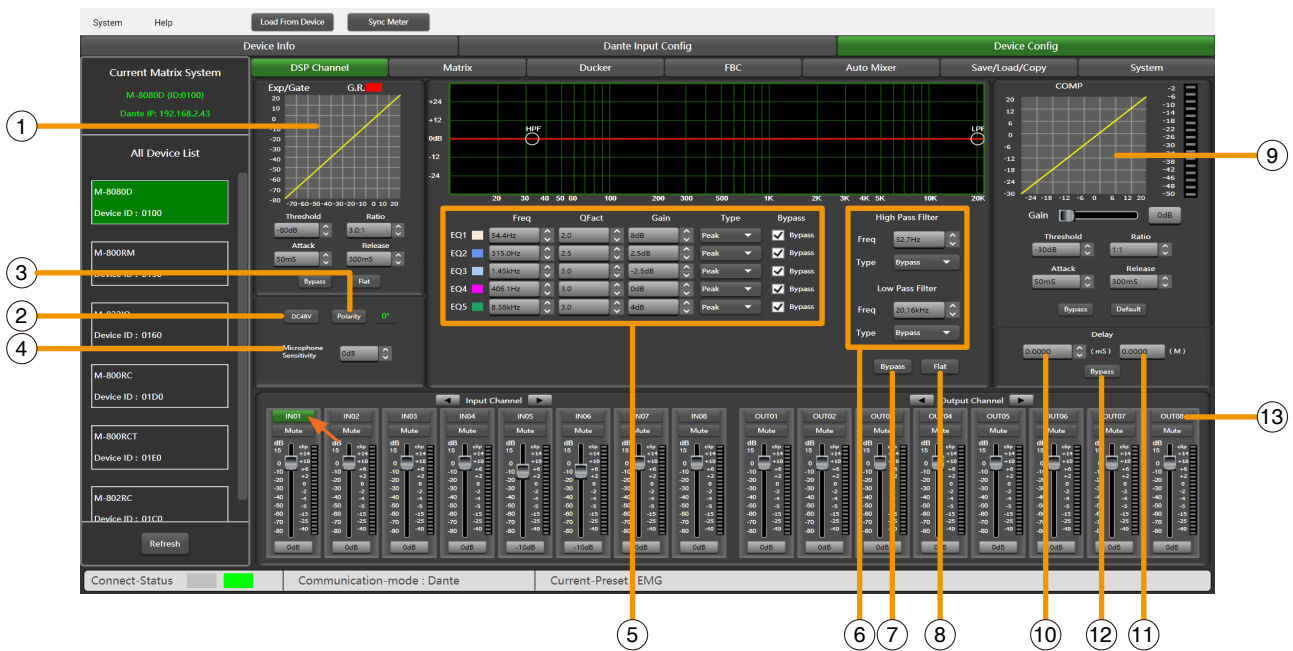

**1. EXP/Gate:** The gate attenuates signals below the threshold value, and allows signals above the threshold value to pass. When the signal is beyond the threshold, the output signal remains identical to the input signal. By adjusting the value of the ratio to its maximum, the Expander is transformed into a Noise Gate.

**Threshold:** -80dB to +20dB. Click this button to set the noise gate trigger level of the selected channel.

**Ratio:** Gain ratio between the input signal and the amplified signal, from 1:1 to 10:1.

**Attack:** Reaction time when the signal is above the specified threshold, from 10 to 150 ms. The attack time is how long it takes the gate to fully open once this threshold has been reached.

**Release:** Reaction time of the Expander when the signal passes below the specified threshold from 10ms to 1000 ms.

**Bypass:** Press this button, the function of this area is invalid.

**Flat:** Restore this area to default settings.

**2. DC48V:** Note this button is only used for external condenser microphone, otherwise it may damage your device, 48V phantom power for electric microphone.

**3. Polarity:** Inverts the phase of the signal by 180°.

**4. Microphone Sensitivity:** Input sensitivity for a microphone, from -48dB to 0dB.

#### 5. Parametric EQ

The equalizer is used to compensate or alter the spectral characteristics of the signal in order to obtain the fattest possible frequency response. The module here is a parametric 5 bands EQ.

**a ) Freq:** Central frequency of the filter between 19.7Hz to 20.16kHz.

**b ) Qfact:** Selectivity range of the filter(Q). The greater the value, the thinner is the processed area of the spectrum. Can be adjusted from 0.4 to 128.

**c ) Gain:** Gain or attenuation of the chosen frequency, from -18dB to +18dB.

**d ) Type:** Filter type, Peak / Low / High.

**e ) Bypass 1~5:** Temporarily cancels the individual processing of filters 1~5 without having to use the general "Bypass".

**6. EQ: High Pass Filter and Low Pass Filter:** Those filters are used to eliminate non necessary frequencies above and below the signal spectrum, in order to avoid any background noise generation due to multi-processing. For instance, a voice microphone will be set to 100Hz for the High Pass and 4kHz for the Low Pass.

**Freq:** Cut-off frequency

**Type:** Filter type

7. **Bypass:** The signal is not processed and skips to the next processing module.

8. **Flat:** All parameters are reset to the factory settings.

### 9. **Comp:**

A compressor can limit the dynamics of a signal beyond a certain level. When the signal exceeds the Threshold it is compressed in a ratio greater than 1. Below the Threshold, input and output signals remain the same. By adjusting the ratio to its maximum value, the compressor is transformed into a limiter.

a ) **Threshold:** Threshold from which the signal is compressed, from -30dB to +20dB.

b ) **Ratio:** Compression ratio. For instance, a 4:1 ratio means that the input level is 4dB above the threshold, the output signal will be 1dB above this threshold. The ratio value can be set from 10:1 to 1:1.

c ) **Attack:** Reaction time of the compressor when the signal is beyond the specified threshold. From 10 to 150ms.

d ) **Release:** Reaction time of the Compressor when the signal is below the specified threshold, from 10ms to 1000ms.

e ) **Bypass:** Press this button, this area function is invalid.

f ) **Default:** Restore Compressor parameters to default.

g ) **Gain:** Adjust the volume level after passing the compressor.

10. **Time Delay:** A delay can be set for each input up to 1361.2916ms. It can be used for sound/video synchro applications or phase adjustment.

11. **Distance Delay:** Adjust the delay by using the distance between different audio sets.

12. **Bypass:** The signal is not processed and skips to the next processing module.

### 13. **Input / Output channel**

a ) **Activation (IN/OUT):** Activate the Input/Output to edit the functions. You will be automatically routed to Input/Output DSP Channel.

b ) **Mute:** Mute the signal.

c ) **Fader:** Adjust the volume of this channel.

d ) **How to modify the channel's name.**

- Double click the channel's name.

- Input the individual name you want to modified.

- Press "Enter" button on the keyboard.

**Attention:** In case of **M-800RCT**, the individual name setting is not transmitted automatically to the device. Use the separate Setting page of **M-800RCT** for setting individual names to be transmitted and indicated on **M-800RCT**.

### Function Example:



Adjusting the high-pass filter to 32.7Hz. Type is adjusted to BW24. Drag EQ1 to 54.4Hz and adjust the Q value to 2.0. Gain up to 8dB. Drag EQ2 to 315Hz. Q value is adjusted to 2.5. Gain to 2.5dB. EQ3 type to 1.45kHz The Q value is unchanged. The gain is attenuated to -2.5dB. The EQ4 type is adjusted to 406.1Hz. The Q value / gain is unchanged, and the EQ5 type is adjusted to 8.38KHz. The Q value does not change and the gain reaches 4dB.

## 8.2. OUTPUT DSP CHANNEL

On the "DSP channel" page, click the output channel name to enter the corresponding output channel DSP settings.



Same menu as the Input DSP Channel, without the Expander/Gate section. The parametric EQ features 8 bands here, instead of 5 bands for the inputs. Please refer to the introduction of Input DSP Channel.

### Function Example:

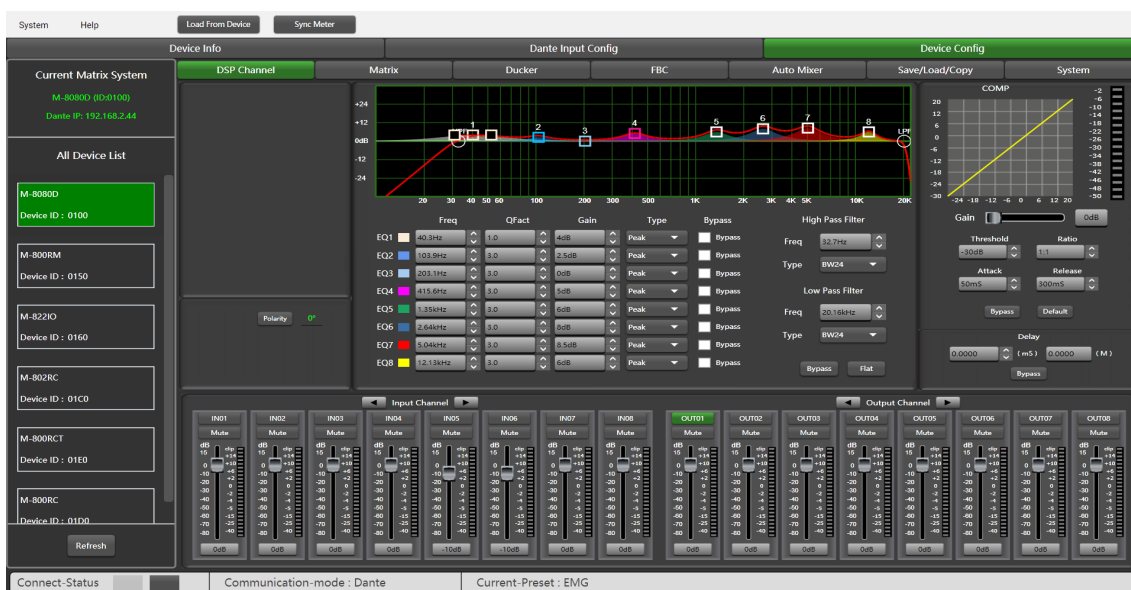

Adjust the high-pass filter / EQ point to the corresponding parameter, which is the same as Input DSP. The waveform in the EQ diagram will also change accordingly.

### 8.3. MATRIX

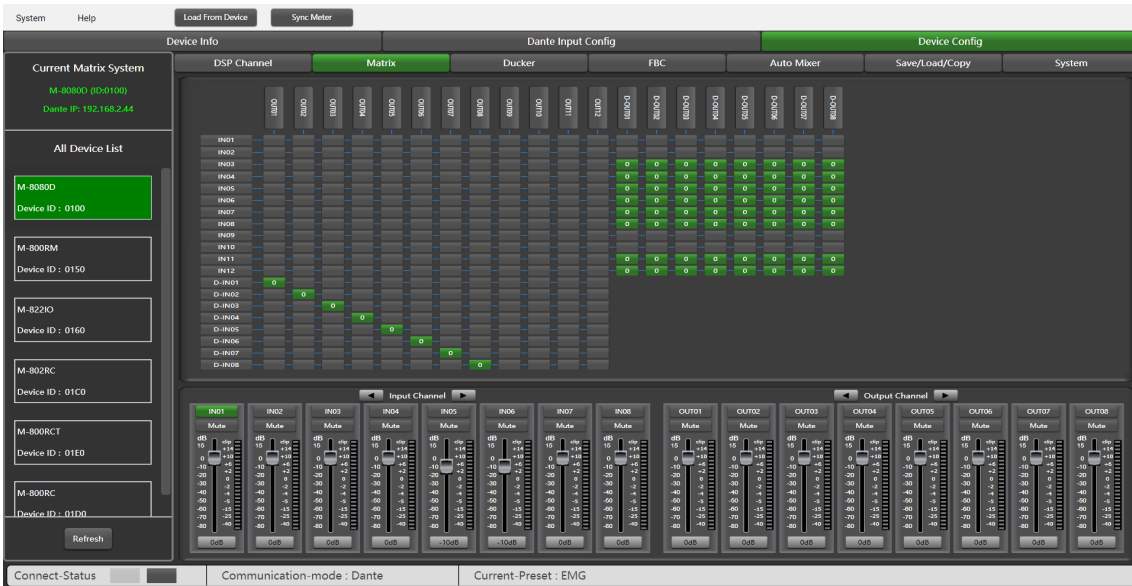

This part of the software is used to route inputs through a graphical representation as a matrix. By clicking on the gray boxes several inputs can be assigned to several outputs. If the connection is active the box turns green, otherwise it remains gray.

- **"Standalone System" mode:** The matrix can route 12 input signals to 12 separate outputs. One talks about a 12x12 matrix.

IN(OUT) 01 to IN(OUT) 08 are analog IN/OUT available on the rear panel.

IN(OUT) 09 to IN(OUT) 12 are digital IN/OUT (RD ports) and are converted to analog signals.

- **"System With Dante Module" mode:** The matrix can route 20 input signals to 20 separate outputs. One talks about a 20x20 matrix.

IN(OUT) 01 to IN(OUT) 08 are analog IN/OUT available on the rear panel.

IN(OUT) 09 to IN(OUT) 12 are digital IN/OUT (RD ports) and are converted to analog signals.

D-IN(OUT) 01 to D-IN(OUT) 08 are Dante digital IN/OUT (**Dante module input port**) and are converted to analog signals.

#### Attention:

The **M-800RM** can only perform matrix settings on the **M-800RM** editor page, and cannot be set on this page. When the **M-800RM** is connected, the corresponding channel matrix function cannot be enabled.

#### Function Example:

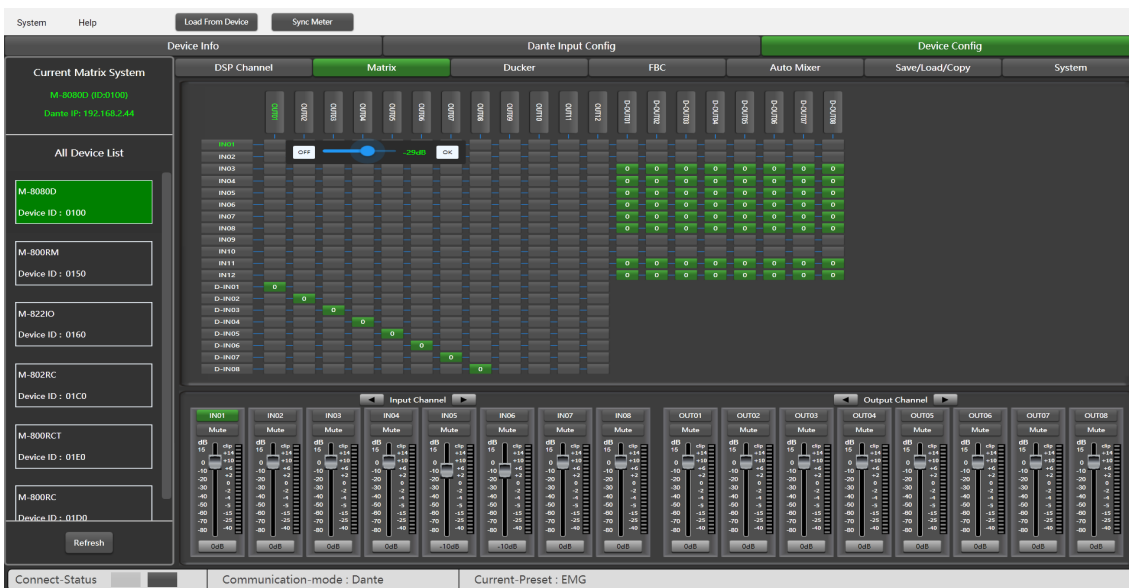

Assign input 1 to output 1: Click the Matrix node, click OFF in the pop-up window, then set the volume to -29dB, and finally click OK. The sound of channel 1 will be adjusted to -29dB.

## 8.4. DUCKER

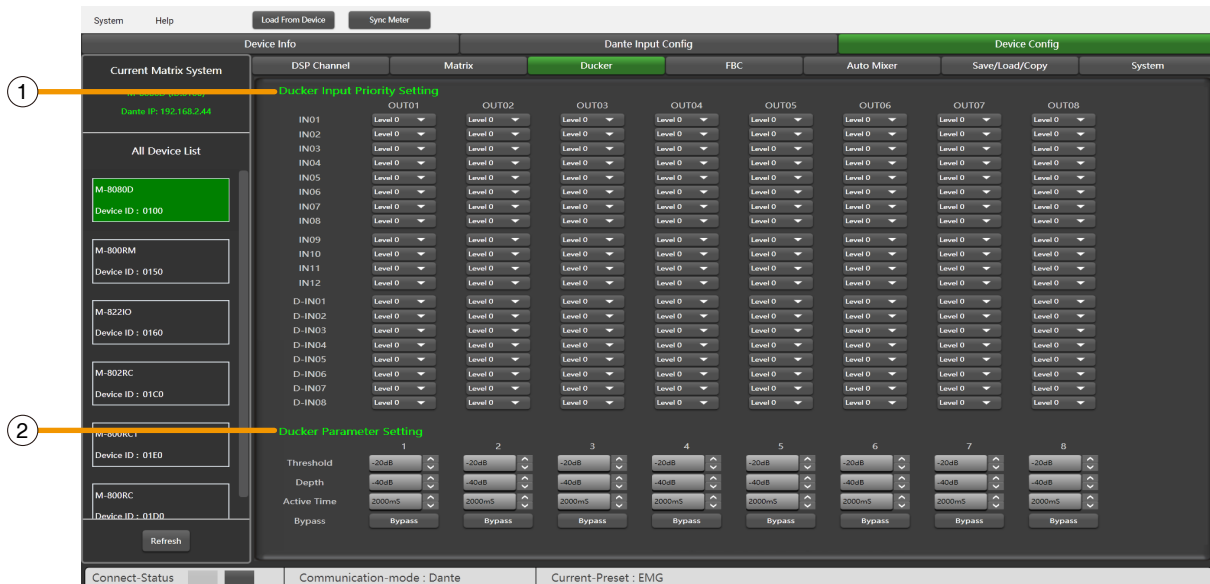

The principle of the Ducker is to attenuate one or several channels when priority signals are activated. The main applications are automatic speech for conference or priority messages.

E.g. use the host microphone signal to control the background music volume. The host automatically reduces the background music volume when speaking. After the speech, the volume of BGM music is automatically restored.

### 1. Ducker Input Priority Setting

Each input corresponds to each output. This area is used to set the priority of input audio 0 - 15. Higher level (higher number) has higher priority. The highest level is 15.

### 2. Ducker Parameter Setting

**Threshold:** Threshold of attenuation. From 0dB to -80dB.

**Depth:** Depth of attenuation.

**Activation Time:** Velocity of gain change to attenuate inputs.

**BYPASS:** The signal is not processed and skips to the next processing module.

### Function Example:

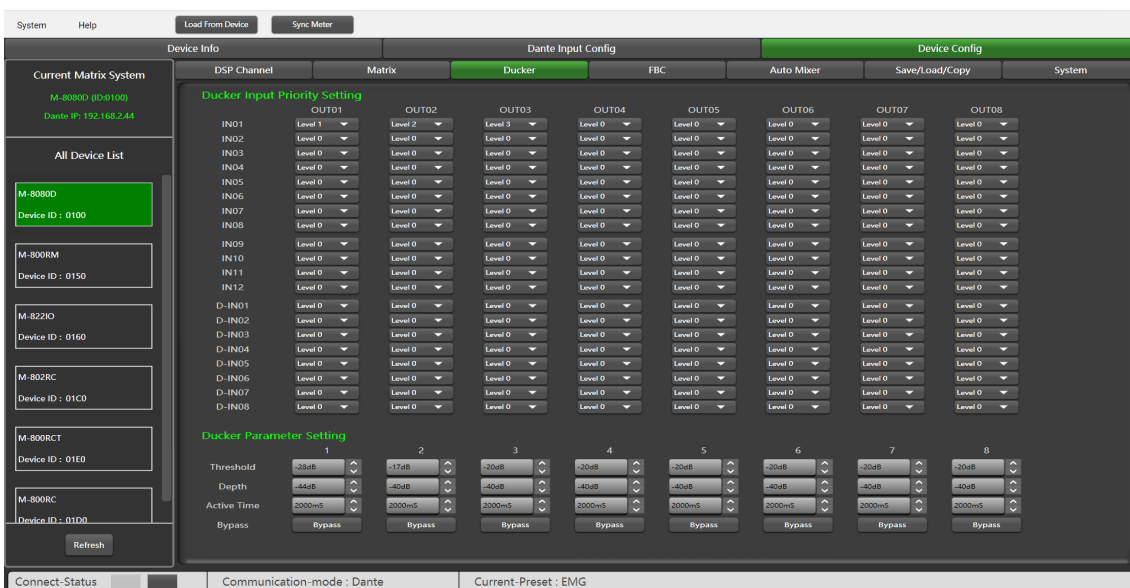

The current setting sets channel 1 to level 1, channel 2 to level 2, and channel 3 to level 3. At the same time, the Threshold, depth, and Activation Time are set at the bottom of the page. The audio source will be output according to the previously set priority and other parameters.

## 8.5. FBC (FEEDBACK COMPRESSION)

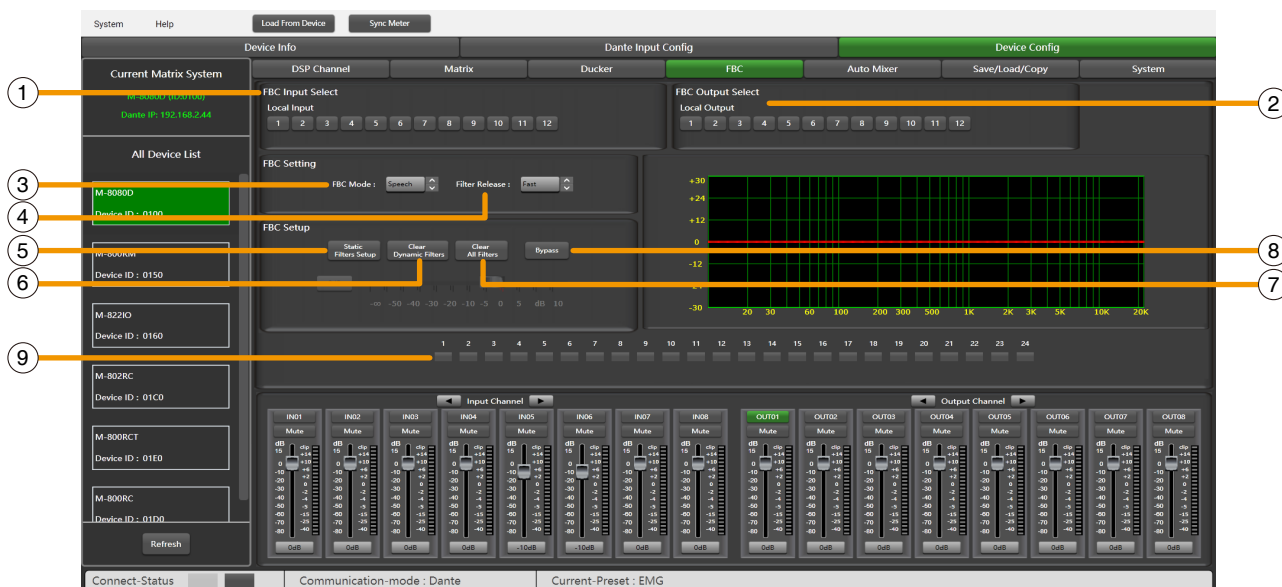

FBC (Feedback compression) function can effectively suppress howling expansion volume, ensure voice transmission quality, high fidelity, and clear sound.

The dynamic filter and the static filter have the same function. They remove unwanted components or features from a signal in a certain frequency range.

The differences between them are:

1. **Static filters:** The frequency points that have been captured remain fixed in their position.
2. **Dynamic filter:** The filter will be eliminated when the feedback vanishes. It is not fixed on a specific frequency.

Even in poor environments, it can greatly suppress the howling and can effectively prevent clipping audio equipment and speakers.

### 1. FBC input Select

There are 12 inputs to choose from. When the corresponding input is lit, the filter of this channel will work. The default is a dynamic filter. The 1-24 light will turn green.

### 2. FBC Output Select

There are 12 outputs to choose from. When the corresponding output is lit, the filter of this channel will work. The default is a dynamic filter. The 1-24 light will turn green.

### FBC Setting:

3. **FBC Mode:** Speech & Music is suitable for meetings and music occasions, howling and clearing are automatically captured.

4. **Filter Release:** Click here to determine the speed of dynamic filter elimination. Fast / Mid / Slow.

### FBC Setup:

5. **Static Filters Setup:** The default is a dynamic filter (the indicator is green). Click Static Filter Setup to switch to static filter (the indicator light turns red).

6. **Clear Dynamic Filters:** Reset all dynamic filters.

The automatic elimination time of dynamic filter has time limit of 2s~3s. At this time, you can press this button to remove immediately.

7. **Clear All Filters:** Reset all dynamic and static filters.

8. **Bypass:** Bypass this area function.

9. **1 - 24 indicators:** Once the system detects the frequency for processing, if it is set as a static filter, the indicator boxes 1 to 24 turn red, and the filtering effect is reflected on the graph. For dynamic filters, attenuation will also appear in the graph and indicator box lit in green.

**Attention:** The M-800RM does not have the FBC function. When the M-800RM is connected, the FBC function of the corresponding channel cannot be enabled.

## Function Example:



Turn on local input / output 1. The corresponding input signal is sent to the FBC module for processing, and the corresponding button is lit to output the signal after FBC processing to the corresponding output channel. Click "Static Filter Setting" to enter the static filter setting mode.

Set the volume of all input channels to the required level and turn on the microphone. Manually gain FBC until howling occurs, in this mode the FBC module will automatically use a static filter. (Static filter indicator is red)

## 8.6. AUTO MIXER

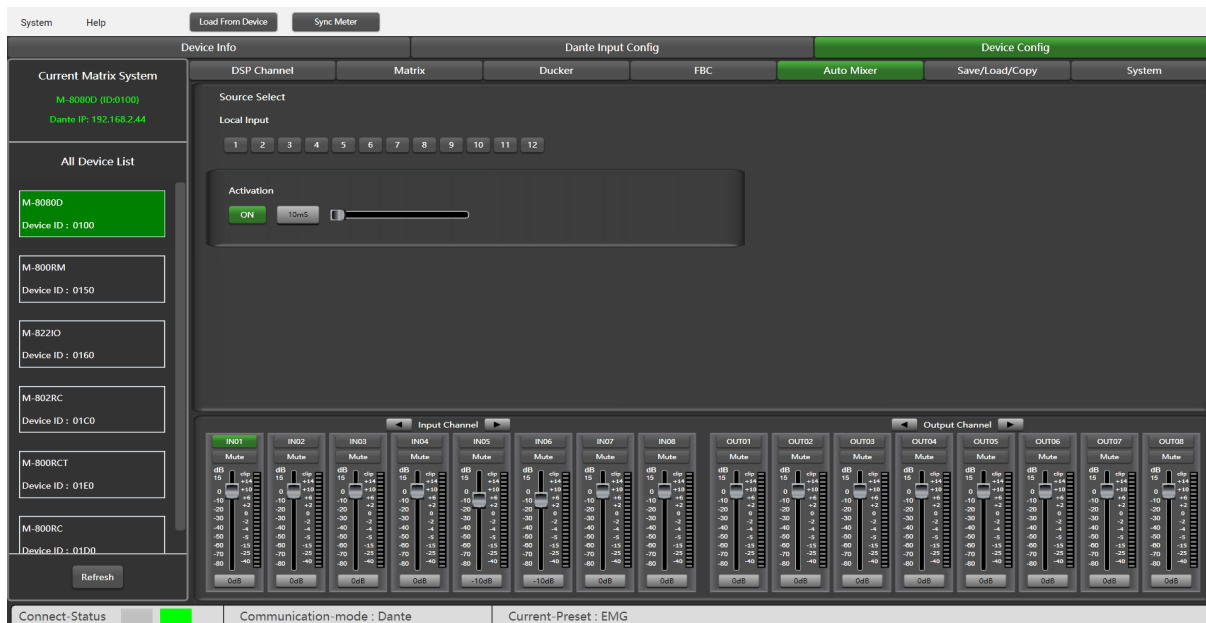

The Auto mixer automatically controls the gains of multiple microphones in real time, dramatically reducing feedback, noise and comb-filtering from adjacent microphones. It maintains a consistent system gain, even when multiple speakers are talking simultaneously, and makes perfectly matched crossfades, without any signal compression.

### Source Select

**Local Input:** selection of input channels (1-12) to be processed.

### Activation Time

Set the start mixing time of the signal of the selected input channel.

Push ON to activate the time setting, and use the horizontal fader to set the time value.

### Function Example:

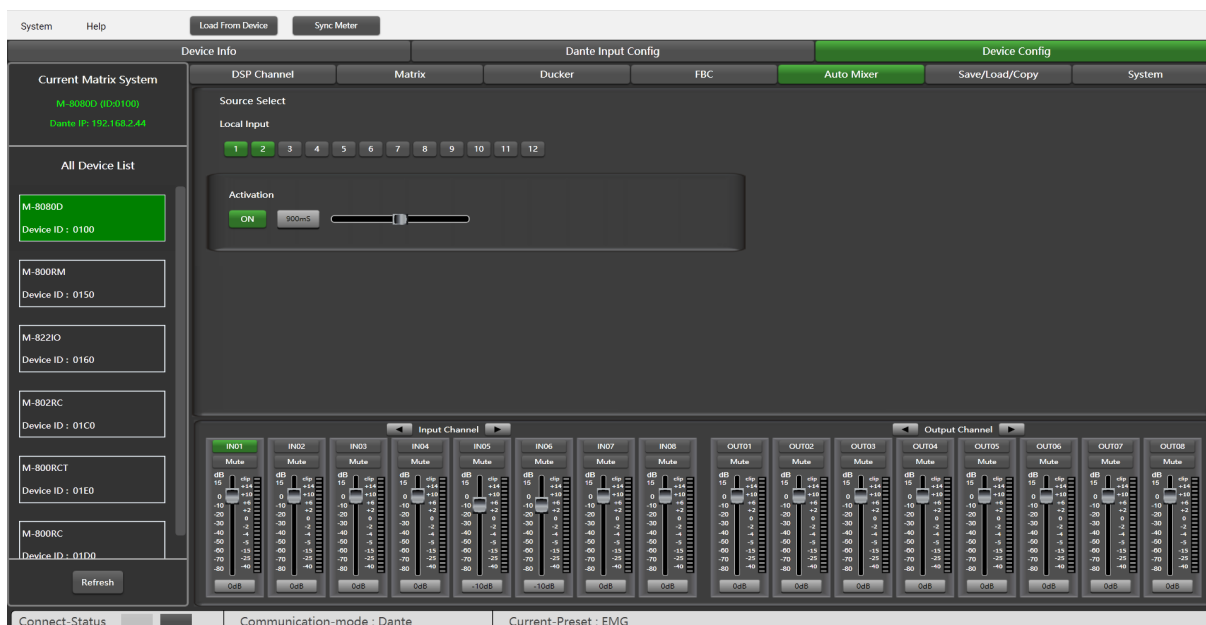

Add the local input CH 1 and CH2 open setting to the automatic mixing function. Input the audio source from two channels. Click the ON button of Active Time and push the fader to set the start mixing time of the CH 1 and CH2 signal. For example, drag the fader to 900ms, the sound source of channel 1 will be at 900ms, and the mixing function is added.

## 8.7. SAVE / LOAD / COPY

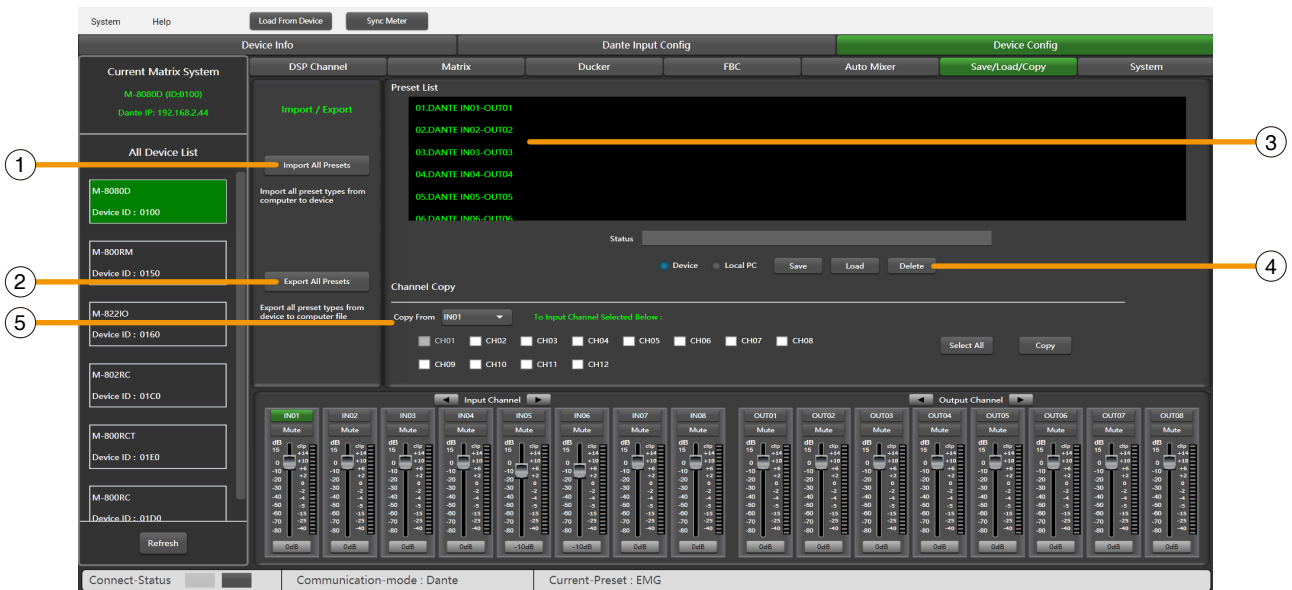

This menu is used to manage the backup parameters. These data can be stored directly in the internal memory of host as a preset. Its memory contains a total of 16 presets.

**1. Import All Preset:** Import all preset types from device to computer file.

**2. Export All Preset:** Export all preset types from computer to device.

**3. Preset List:** The preset list shows all saved presets. The status below shows the current operating status.

### 4. Device / Local PC

**Note:** The save/load/delete operations here are limited to the preset list. All device configuration data except the preset list need to be operated through "Load All" and "Save As..." under the "System" menu.

#### a ) If Device is selected

**-Load:** First to select a preset, click OK to load, wait a few seconds until finished.

**-Save:** Select a preset in the preset list, then customize the name, click Save button, and the modification will be successful.

**-Delete:** Select a preset and click Delete, the preset will be deleted.

#### b ) When Local PC is selected

**-Load:** Select Local PC and click Load, indicating that the preset will be loaded locally from the computer.

**-Save:** When Local PC is selected, click Save to save the current preset to the computer.

### 5. Channel Copy

Input / output channels (1~12) can be selected and copied to any channel (1~8) in the check box.

**Select All:** Click this button, all CH1~CH8 will be selected.

**Copy:** After selecting the input / output channel to any other channel, click Copy, and the parameter copy is successful.

## Function Example 1:

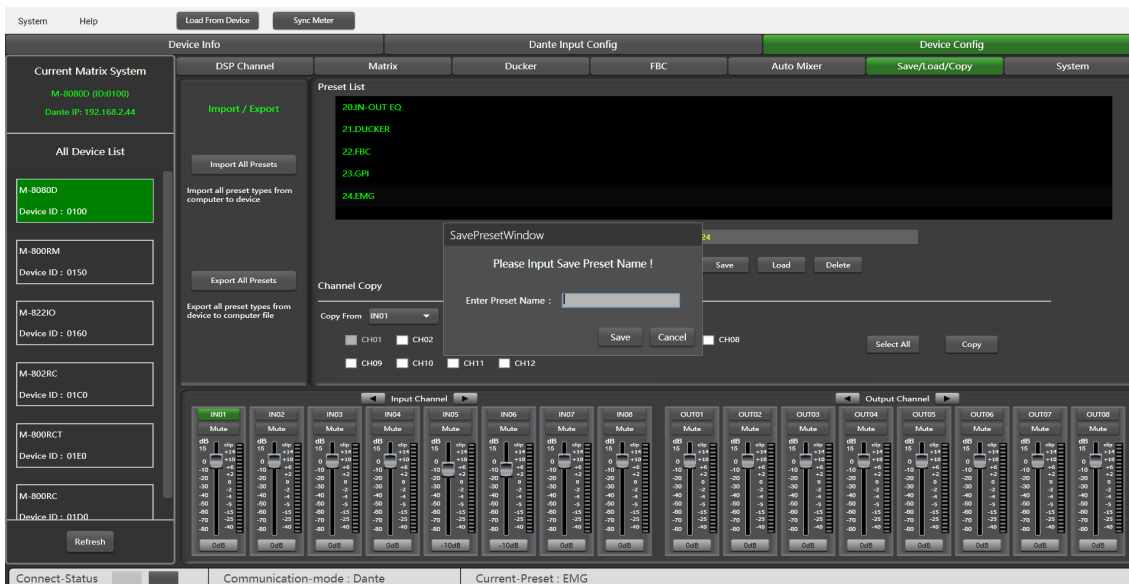

Save current preset to device

- 1) Select Device and click Save button.
- 2) Enter the preset name in the pop-up window.
- 3) Click Submit button to save the preset.

**Note:** The preset list is saved separately and are not included in the system saving.

## Function Example 2:

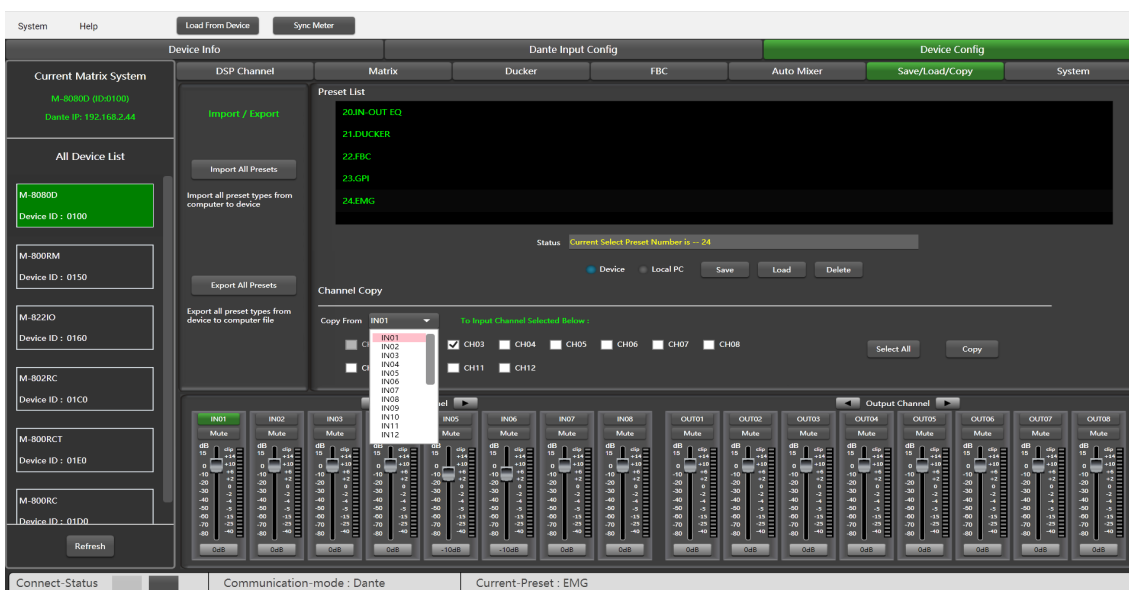

Select the input channel IN01 to copy to CH03. Click the Copy button, the parameters of input channel 01 will be copied to CH03.

## 8.8. SYSTEM

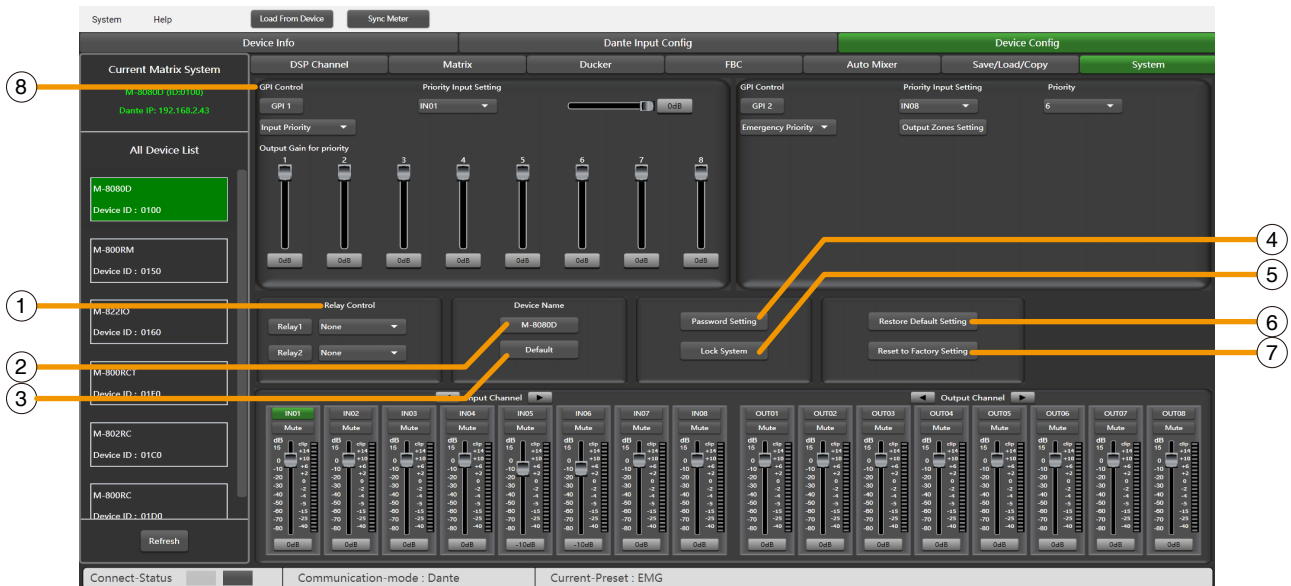

**1. Relay Control:** Either IN01-IN08 or Paging (**M-800RM**) can be selected. When there is a broadcast signal on the selected channel, the corresponding relay terminal on the rear panel of the **M-8080D** will make contact and can be used to control the start-up/shutdown of external devices.

**2. Device Name:** You can customize the device name here. After modification, press the Enter key to easily set.

**3. Default:** Change device name to default setting M-8080D.

**4. Password Setting:** Press this button to modify the password.

**5. Lock System:** Press this button to lock the system. It is locked at this time, you need to enter the password to unlock, if you forget the password, you can use the super password MA88 to unlock.

**6. Restore Default Setting:** Restores all settings except the preset list to default settings.

**7. Reset to Factory Setting:** Clears all settings, including preset lists.

### 8. GPI Control:

For easy control of IN/OUT priority (GPI function is top priority) and the volume of the selected IN/OUT.

**Note:** The open voltage of GPI is 1.5V, and the open resistance is 200Ω. It is only used for relay or switch control.

Wire drawing (GPI 1 short)

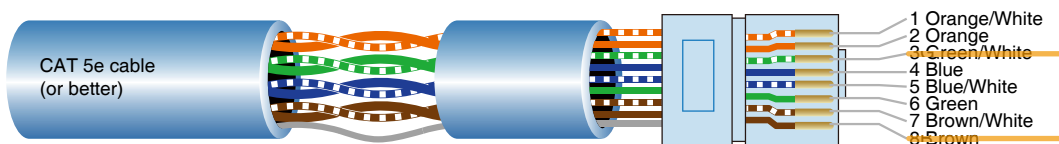

1) Put the cable insert to the GPI 1 port in the back plate.

2) The other end connects the green/white wire and the brown wire in the network cable to form a short circuit.

3) The GPI light on the software will automatically light up (green), which means that it is enabled.

4) Set priority type according to demand.

Wire drawing (GPI 2 short)



1) Put the cable insert to the GPI 2 port in the back plate.

2) The other end connects the green wire and the brown wire in the network cable to form a short circuit.

3) The GPI light on the software will automatically light up (green), which means that it is enabled.

4) Set priority type according to demand.

### GPI Control Mode 1: Input Priority



**a. Priority Input Setting:** Select input 1-8 for priority control.

**b. Output gain for priority:** It used to control the output gain of the priority channel.

### GPI Control Mode 2: Mute All Outputs



### GPI Control Mode 3: Emergency Priority



Emergency Priority is only used for emergency broadcast. This mode has higher priority than "DUCKER". When emergency broadcast is triggered, the broadcast volume setting of the corresponding channel (whether it is mute or minimum volume) will automatically return to the default volume.

**c. Priority Input Setting:** Select input 1-8 for priority control.

**d. Priority level:** Higher level (higher number) has higher priority, the highest level is 16.

**e. Output Zones Setting:** Select the output channel, set it in the pop-up window.

## Output Zones Setting

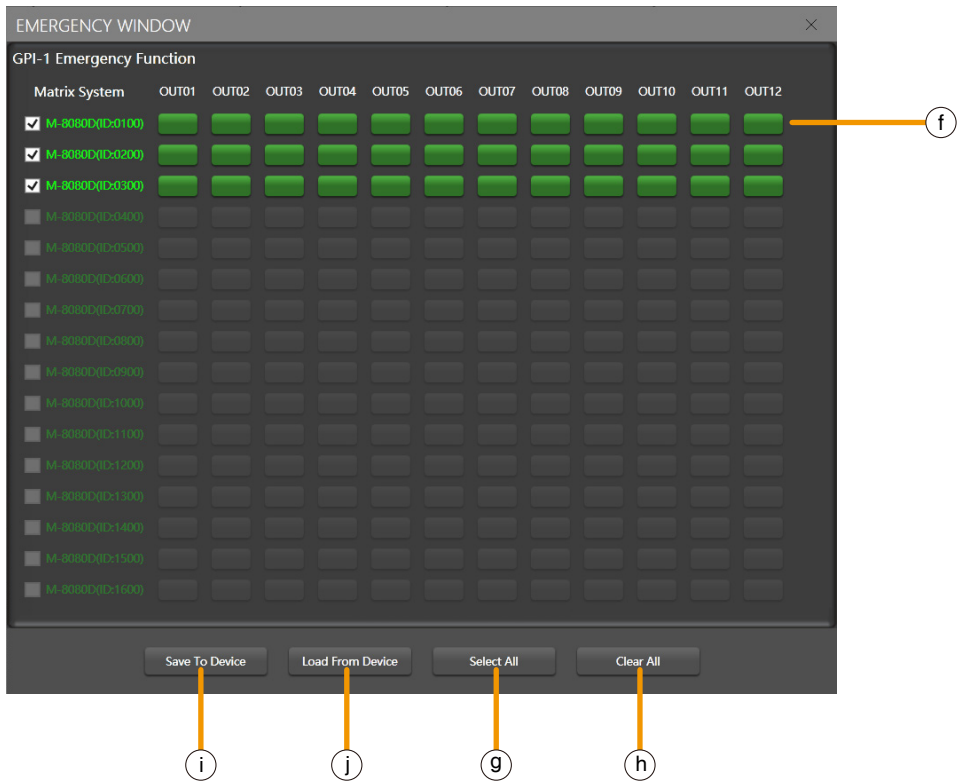

**f. Output channel selection area:** Select the corresponding output channel, green is selected, gray is not selected.

**g. Select All:** Select all output channels.

**h. Clear All:** Cancels all selected output channels.

**i. Save to Device:** After selection, this button must be clicked to save the settings to the device to take effect.

**j. Load from Device:** Load settings from device.

### Function Example 1:



Click Password Setting, enter the current password and the password you want to modify, click Confirm, the password will be successfully modified.

### Function Example 2:

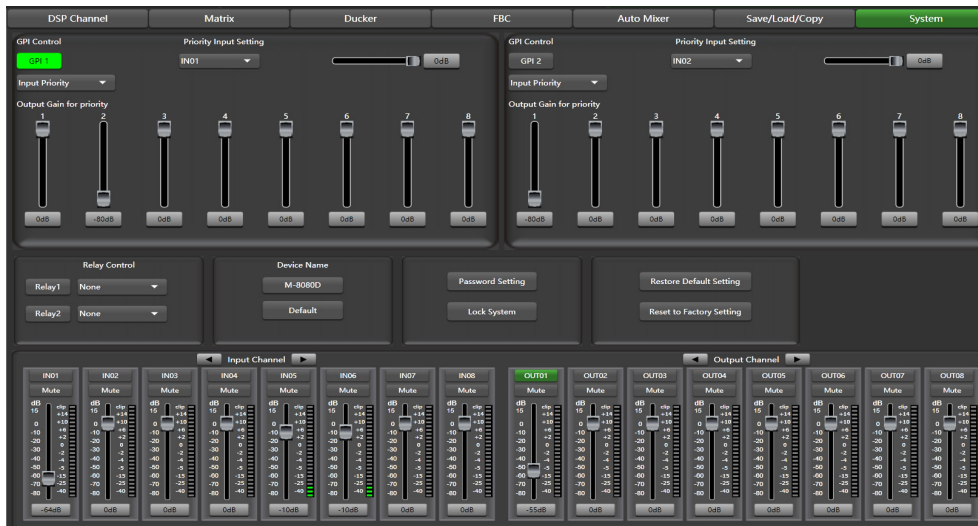

- 1) According to the method described earlier, insert one end of the network cable into the GPI 1 port on the rear panel of the machine, and the other end is short-circuited.
- 2) The GPI 1 port on the PC software lights up to indicate that this function is enabled.
- 3) According to the set input priority and the selected IN01. At this point, only the IN01 input signal has output.

### Function Example 3:

The volume of input channel 01 is relatively low, and the volume of output channel 01 is muted.

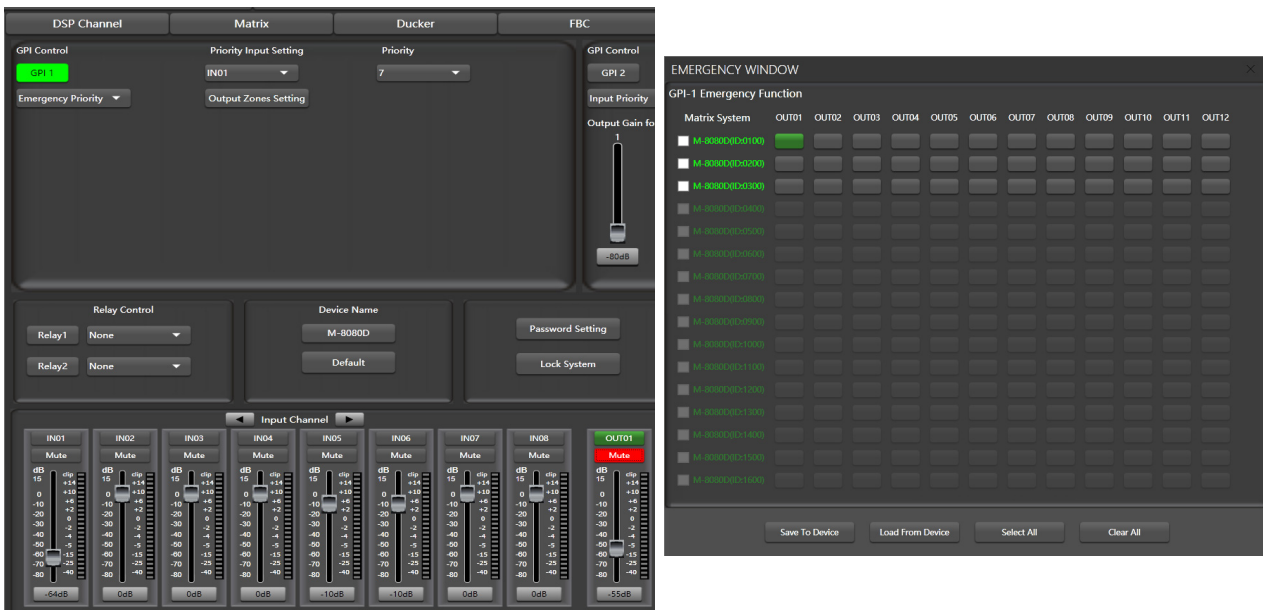

- 1) According to the method described earlier, insert one end of the network cable into the GPI 1 port on the rear panel of the machine, and the other end is short-circuited.
- 2) The GPI 1 port on the PC software lights up to indicate that this function is enabled.
- 3) According to the set emergency priority and the selected IN01 and OUT01. At this time, the input signal of IN01 can be output to OUT01 using the default volume.

### Shortcut buttons on the "Device Config" page



1. **Load From Device:** Load the preset on the device to the PC software.
2. **Sync Meter:** When the network connection between the computer and the device is incorrect, causing the settings of the PC software and the device to be different, click this button to synchronize.

## 9. REMOTE DEVICES

M-8080D offers a large choice of devices for volume adjustment, paging management, routing and IN/OUT modules.

### 9.1. M-800RM

The **M-800RM** is a paging microphone and can address 1 to 12 different zones (outputs). A total of 2 x **M-800RM** can be used in a stand-alone system and a maximum of 32 x **M-800RM** in a Dante system, which makes a lot of possibilities for message paging.

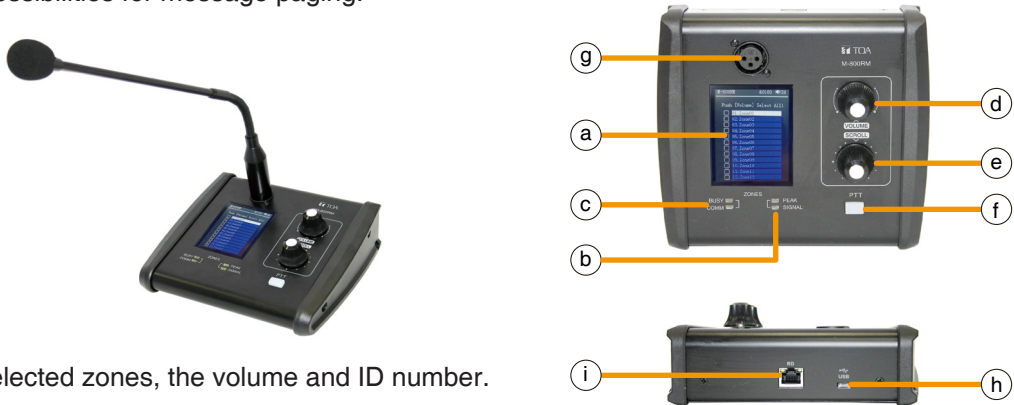

#### a. LC-Display

It displays the selected zones, the volume and ID number.

#### b. Signal status indicators

The green LED indicates the presence of signal when the microphone is ON.

The red LED indicates the limit of clipping.

#### c. Communication status indicators

When communication with the M-8080D is correct, the green COMM indicator flashes.

When multiple microphones with different priority levels try to broadcast to the same area, the microphone with the higher priority level can broadcast normally. The microphone with lower priority BUSY red indicator will light up and the LC-display will indicate "Paging Busy..." until the microphone with the higher priority is finished broadcasting.

When multiple microphones with the same priority are trying to broadcast to the same area, the microphone that broadcasts first has a higher priority and can broadcast normally. The red BUSY indicator of the microphone that broadcasts later will light up and the LC-display will indicate "Paging Busy..." until the higher priority microphone has finished broadcasting and can then broadcast normally.

#### d. Volume control and all zone selector

It controls the volume of the microphone for each selected zones.

By pushing on the button, it selects all zones.

#### e. Zone selector

It selects one or several zones by turning the button left or right and pushing on it to validate.

#### f. Push-to-talk switch

When the button is pushed, the chime sounds and the red ring on the microphone lights up indicating that one can talk.

#### g. XLR connector

Female 3 pin XLR connector for the gooseneck electret microphone. It uses a phantom power controlled by software.

#### h. USB port

This port is used to load WAV / MP3 files for chimes sound. The maximum time for the chimes is 4 seconds.

#### WAV vs. MP3

Available Bit Rates: 8 ~ 128 kbps, sampling rates: 8 ~ 44.1 kHz.

#### How to transfer chimes to the M-800RM

1. Using a USB cable to connect the USB port on the rear panel of the machine to the computer.
2. Open My computer will display a removable storage disk.
3. Drag the chimes you want into the Removable disk to complete the USB audio import.

**Note:** The maximum storage space of the device is 1MB.

#### i. RD port

Connects to the RD port of the **M-8080D** or the RD EXP port 1 of **M-804EX**. The maximum shielded CAT 5e cable length is **100 meters**.

#### Attention:

Not a plug and play port, please power off the **M-8080D** before connecting.

The braid screen or foil of the shielded CAT 5e cable must be securely connected to the metal shell of the shielded RJ45 connector.

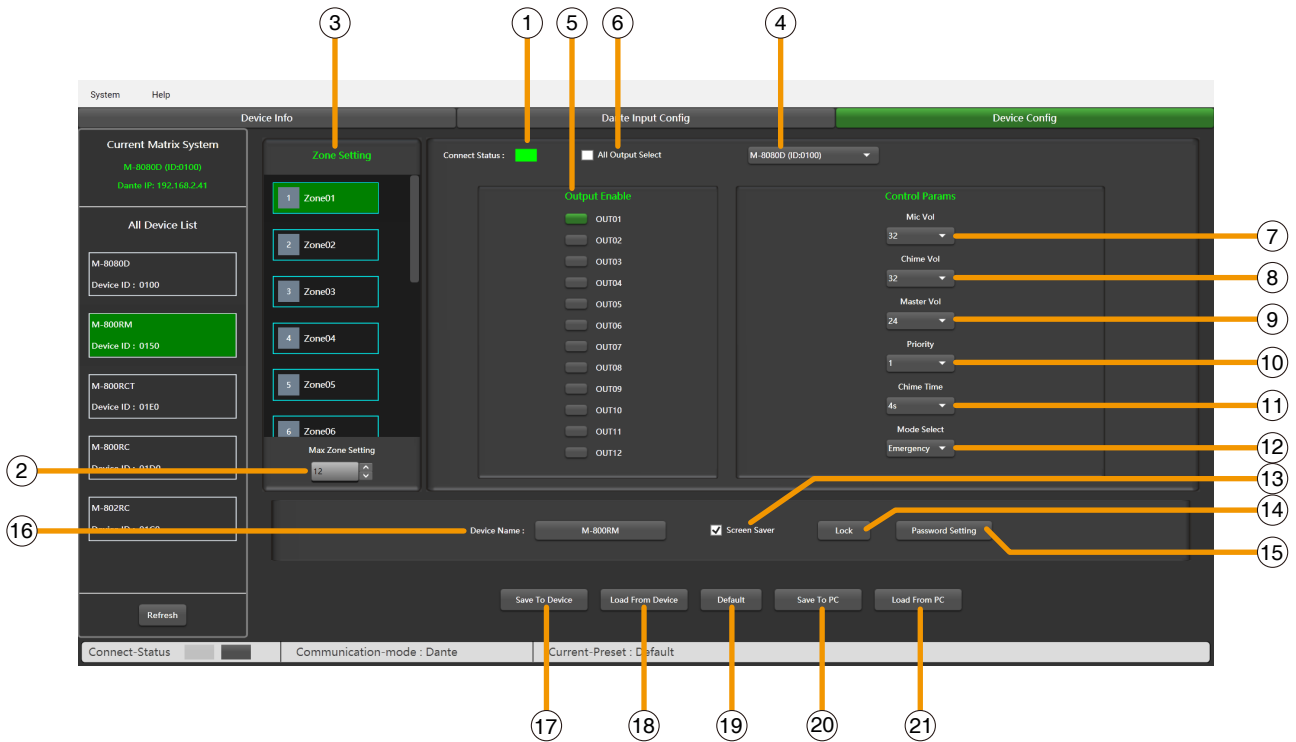

This function is a zone setting with audio routing function. You can control up to 12 output channels in a single zone. Distribute audio to different zones, and easily manage zones by adjusting the chime time / volume / priority.

- 1. **Connect Status:** When the signal light shows green, it means the communication status is normal. If it shows gray, it means no communication.
- 2. **Max Zone Setting:** Maximum 64 zones can be set up and managed.
- 3. **Zone Setting:** Each zone can select 1-12 outputs.
- 4. **Online M-8080D Select:** Each zone (3) can select any online M-8080D's 1-12 outputs (5).
- 5. **Output Enable:** Select the output channel corresponding to the zone, green when selected, gray when unselected.
- 6. **All Output Select:** Select all output channels at once.
- 7. **Mic Volume:** Microphone volume adjustment. The volume level is 0~32dB.
- 8. **Chime Volume:** Control the playback volume of audio files. The volume level is 0~32dB.
- 9. **Master Volume:** Audio master volume adjustment. The volume level is: 0~32dB.
- 10. **Priority:** Priority setting. The priority level is: 1-16. Higher level (higher number) has higher priority.
- 11. **Chime Time:** Chime playing time. The interval is: 0.1S~12S.
- 12. **Mode Select:** Either emergency broadcast mode or normal broadcast mode can be selected. Emergency is only used for emergency broadcast. This mode has the highest priority, higher than GPI Control Mode 3 "Emergency Priority" and "DUCKER". When **M-800RM** emergency broadcast is triggered, the broadcast volume setting of the corresponding zone (whether it is mute or minimum volume) will automatically return to the default volume.
- 13. **Screen saver:** When this box is checked, the device will enter the sleep state if there is no operation for one minute.
- Note:** The factory setting is ON. In order to prolong the life of the LC-Display, it is recommended that the user set it to ON.
- 14. **Lock / Unlock:** Click to lock the M-800RM. Click Unlock and enter the password (15) to unlock. If you forget the password, you can use the factory password "0000" to unlock.
- 15. **Password Setting:** Numbers and letters can be entered as the password.

- 16. Device Name:** The default name is displayed in the box, click to modify the device name.
- 17. Save To Device:** After the settings are modified, they need to be saved to the device to take effect.
- 18. Load from Device:** Load presets from device to PC.
- 19. Default:** Initialize preset parameters.
- 20. Save to PC:** Save current preset to PC.
- 21. Load from PC:** Load selected preset from PC.

**9.2. M-800RC**



This volume controller can be assigned to any output of the M-8080D. It can also route any input to any output like in the Matrix menu of the Editor Software.

**a. LC-Display**

It displays the volume level and the signal level for a dedicated output, the ID and communication status.

**b. Volume and routing control**

Turn the button left or right to adjust the volume.  
Push the button to access to the inputs and outputs routing menu.

**c. RD IN**

Connect to the RD port of the **M-8080D** or the RD EXP port of the **M-804EX / M-800RCT / M-800RC**.

The maximum shielded CAT 5e cable length is **100 meters**.

**Attention:**

Not a plug and play port, please power off the **M-8080D** before connecting.  
The braid screen or foil of the shielded CAT 5e cable must be securely connected to the metal shell of the shielded RJ45 connector.

**d. RD EXP**

Connect to the RD IN port of the **M-800RCT, M-800RC, M-802RC** or **M-822IO**.

Daisy connection for additional remote controller (4 controllers max).

The maximum shielded CAT 5e cable length for daisy chain **100 meters** in total from **M-8080D** RD port to last controller.

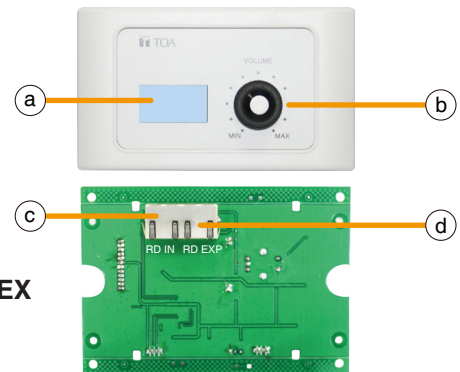

**Wall installation instructions:**

1. Unscrew the 2 x fixing screws of the device and casing.
2. Fix casing to wall.
3. Insert the distributed network cable into the RD IN port, and screw the device to the casing.
4. Attach the decorative panel.

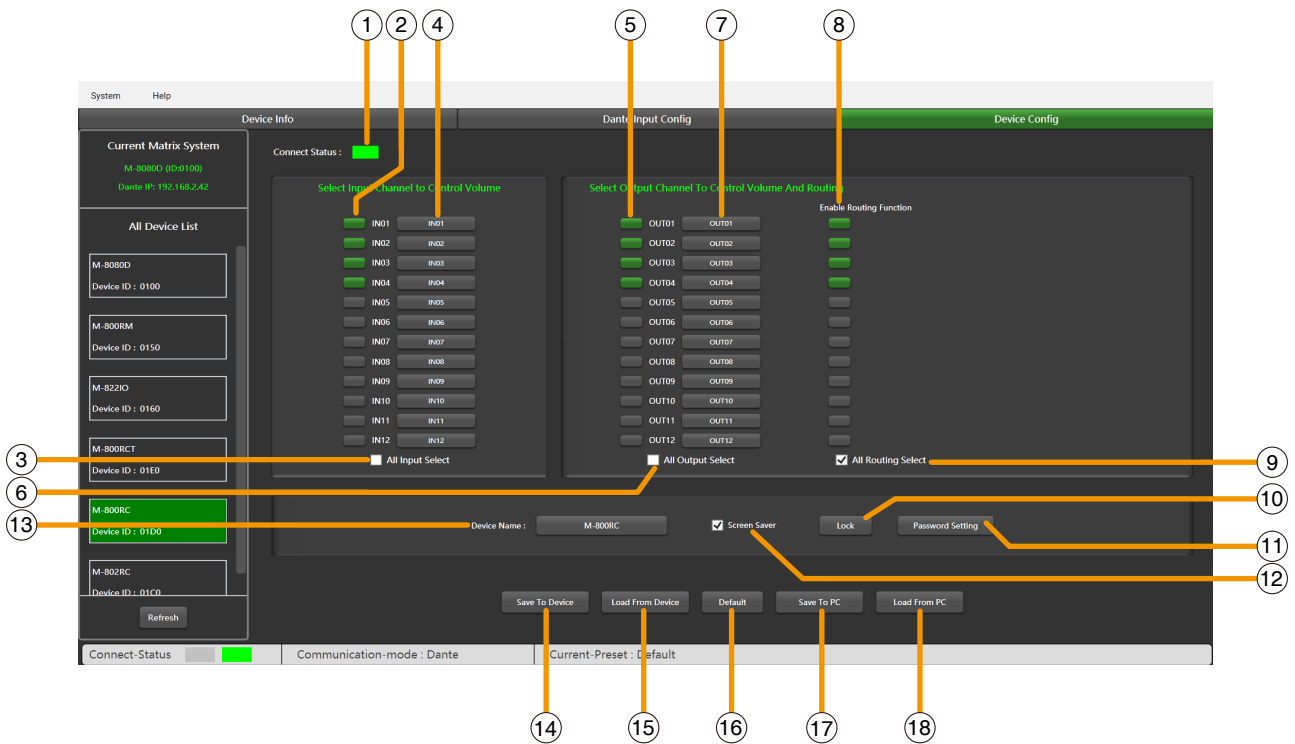

1. **Connect Status:** When the signal light shows green, it means the communication status is normal. If it shows gray, it means no communication.
  2. **Select Input Channel to Control Volume:** Selected is green, unselected is gray.
  3. **All Input Select:** Select all input channels at once.
  4. **Input Channel Name:** The default name is displayed in the box, click to modify the input channel name.
  5. **Select Output Channel to Control Volume:** Selected is green, unselected is gray.
  6. **All Output Select:** Select all output channels at once.
  7. **Output Channel Name:** The default name is displayed in the box, click to modify the output channel name.
  8. **Enable Routing Function:** Click to control the routing of output channels, selected is green, unselected is gray.
  9. **All Routing Select:** Select all routes at once.
  10. **Lock / Unlock:** Click to lock the M-800RC. Click unlock and enter the password (11) to unlock. If you forget the password, you can use the factory password "0000" to unlock.
  11. **Password Setting:** Numbers and letters can be entered as the password.
  12. **Screen saver:** When this box is checked, the device will enter the sleep state if there is no operation for one minute.
- Note:** The factory setting is ON. In order to prolong the life of the LC-Display, it is recommended that the user set it to ON.
13. **Device Name:** The default name is displayed in the box, click to modify the device name.
  14. **Save To Device:** After the settings are modified, they need to be saved to the device to take effect.
  15. **Load from Device:** Load presets from device to PC.
  16. **Default:** Initialize preset parameters.
  17. **Save to PC:** Save current preset to PC.
  18. **Load from PC:** Load selected preset from PC.

### 9.3. M-802RC



The **M-802RC** has the same functionality as the **M-800RC** volume control, but it includes 2 additional analog outputs. The device includes a built-in D/A converter processing digital audio AES3 signals from **M-8080D**. **M-802RC** requires/consumes 2x digital output channels of in total 4 available digital output channels of **M-8080D**.

#### a. LC-Display

It displays the volume level and the signal level for a dedicated output, the ID and communication status.

#### b. Volume and routing control

Turn the button left or right to adjust the volume.

Push the button to access to the inputs and outputs routing menu.

#### c. RD IN

Connect to the RD port of the **M-8080D** or the RD EXP port 1 of the **M-804EX** or RD EXP port of the **M-800RC / M-800RCT**. (**M-800RC / M-800RCT** needs to be connected to RD port of the **M-8080D** or the RD EXP port 1 of the **M-804EX**.)

The maximum shielded CAT 5e cable length is **100 meters**.

#### Attention:

Not a plug and play port, please power off the **M-8080D** before connecting.

The braid screen or foil of the shielded CAT 5e cable must be securely connected to the metal shell of the shielded RJ45 connector.

#### d. Analog OUT

2 channel analog line outputs assigned to RD port 9 / 10 or 11 / 12 of **M-8080D**.

#### Wall installation instructions:

1. Unscrew the 2 x fixing screws of the device and casing.
2. Fix casing to wall.
3. Insert the distributed network cable into the RD IN port, connect the analog output cable, and screw the device to the casing.
4. Attach the decorative panel.

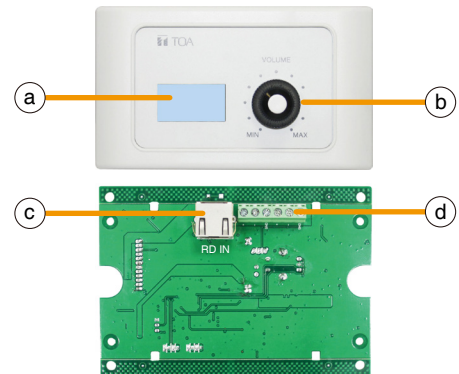

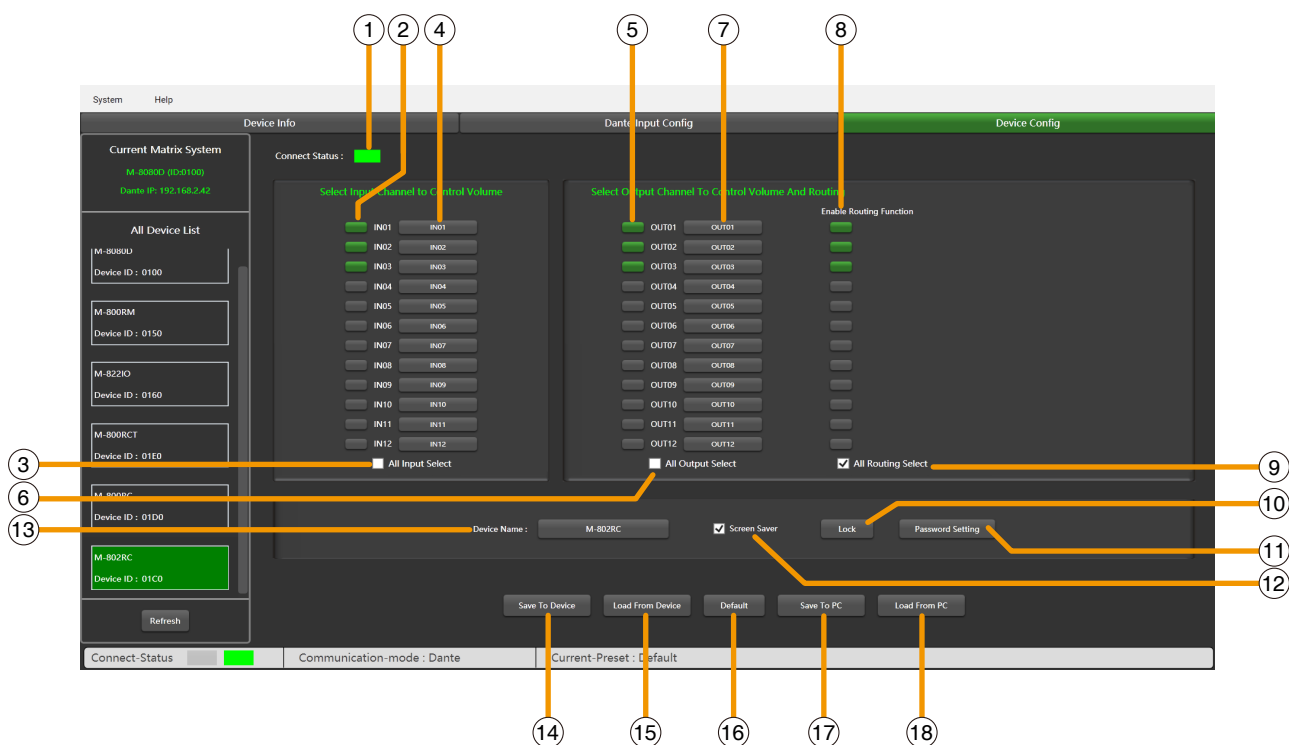

1. **Connect Status:** When the signal light shows green, it means the communication status is normal. If it shows gray, it means no communication.
2. **Select Input Channel to Control Volume:** Selected is green, unselected is gray.
3. **All Input Select:** Select all input channels at once.
4. **Input Channel Name:** The default name is displayed in the box, click to modify the input channel name.
5. **Select Output Channel to Control Volume:** Selected is green, unselected is gray.
6. **All Output Select:** Select all output channels at once.
7. **Output Channel Name:** The default name is displayed in the box, click to modify the output channel name.
8. **Enable Routing Function:** Click to control the routing of output channels, selected is green, unselected is gray.
9. **All Routing Select:** Select all routes at once.
10. **Lock / Unlock:** Click to lock the M-802RC. Click unlock and enter the password (11) to unlock. If you forget the password, you can use the factory password "0000" to unlock.
11. **Password Setting:** Numbers and letters can be entered as the password.
12. **Screen saver:** When this box is checked, the device will enter the sleep state if there is no operation for one minute.
- Note:** The factory setting is ON. In order to prolong the life of the LC-Display, it is recommended that the user set it to ON.
13. **Device Name:** The default name is displayed in the box, click to modify the device name.
14. **Save To Device:** After the settings are modified, they need to be saved to the device to take effect.
15. **Load from Device:** Load presets from device to PC.
16. **Default:** Initialize preset parameters.
17. **Save to PC:** Save current preset to PC.
18. **Load from PC:** Load selected preset from PC.

## 9.4. M-822IO



The **M-822IO** is a remote audio input and output module providing 2 x analog channels IN and 2 x analog channels OUT. The device includes built-in A/D and D/A converters processing digital audio AES3 signals from and to the **M-8080D**.

**M-822IO** requires/consumes 2x digital input + 2x digital output channels. In total 4 available inputs and 4 available output channels can be occupied.

### a. 2 Channel inputs

A & B analog line inputs assigned to channels 9/10 or 11/12 of **M-8080D**.

### b. Microphone input

XLR connector for MIC. If connected, it replaces the A channel input.

### c. Microphone volume

Knob for adjusting the MIC input level.

### d. Phantom power

48V switchable phantom power for electret MIC.

### e. Signal indicators for the inputs

Channel A (MIC) and B input signal status indicators for signal presence and clip.

### f. Signal indicators for the outputs

RD port 9 / 10 or 11 / 12 output input signal status indicators.

### g. RD IN

Connect to the RD port of the **M-8080D** or the RD EXP port 1 of the **M-804EX** or RD EXP port of the **M-800RC** / **M-800RCT**. (**M-800RC** / **M-800RCT** needs to be connected to RD port of the **M-8080D** or the RD EXP port 1 of the **M-804EX**.)

The maximum shielded CAT 5e cable length is **100 meters**.

### Attention:

Not a plug and play port, please power off the **M-8080D** before connecting.

The braid screen or foil of the shielded CAT 5e cable must be securely connected to the metal shell of the shielded RJ45 connector.

### h. Analog OUT

2 channel analog line outputs assigned to RD port 9 / 10 or 11 / 12 of **M-8080D**.

### Wall installation instructions:

1. Unscrew the 2 x fixing screws of the device and casing.
2. Fix casing to wall.
3. Insert the distributed network cable into the RD IN port, connect the analog output cable, and screw the device to the casing.
4. Attach the decorative panel.

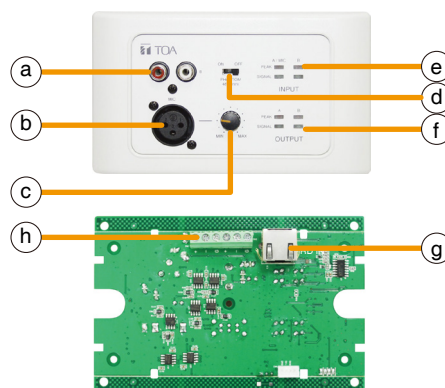

## M-822IO Editor

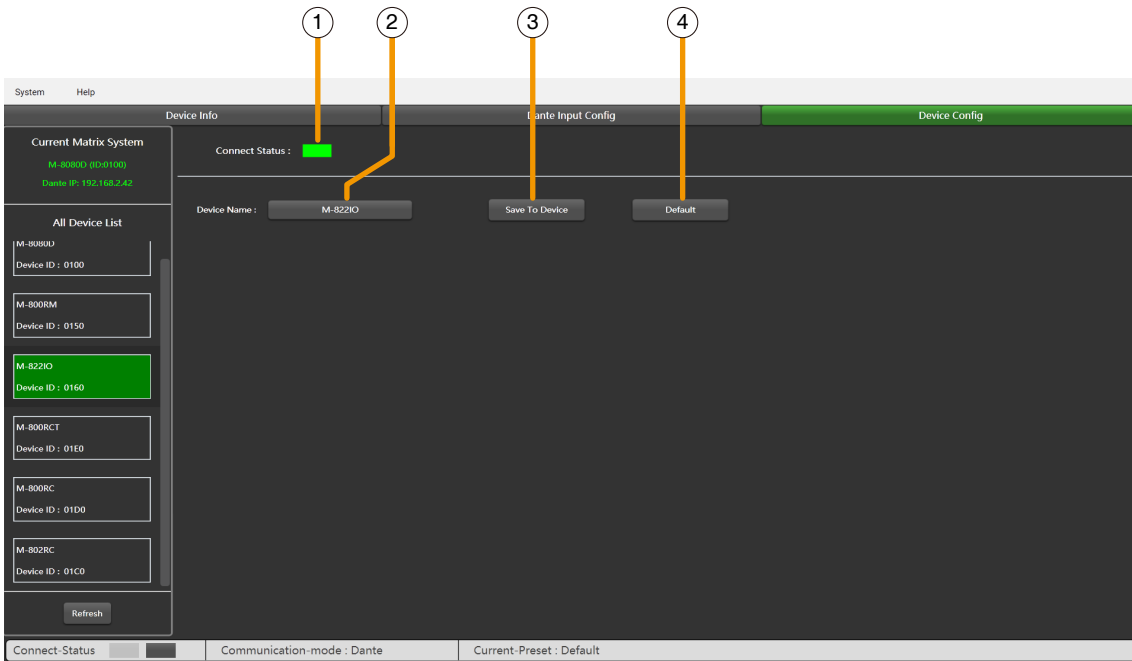

1. **Connect Status:** When the signal light shows green, it means the communication status is normal. If it shows gray, it means no communication.
2. **Device Name:** The default name is displayed in the box, click to modify the device name.
3. **Save To Device:** After the device name is modified, it needs to be saved to the device to take effect.
4. **Default:** Initialize preset parameters.

### 9.5. M-800RCT



The **M-800RCT** is a wall mount 4.3" touch LC-Display volume controller.

Touch LC-Display shows the volume level and the signal level for a dedicated output, the ID and communication status.

It can be assigned to any output of the **M-8080D**. It can also route any input to any output like in Matrix menu of the Editor Software.

#### a. RD IN

Connect to the RD port of the **M-8080D** or the RD EXP port of the **M-804EX / M-800RCT**.

The maximum shielded CAT 5e cable length is **100 meters**.

#### Attention:

Not a plug and play port, please power off the **M-8080D** before connecting.

The braid screen or foil of the shielded CAT 5e cable must be securely connected to the metal shell of the shielded RJ45 connector.

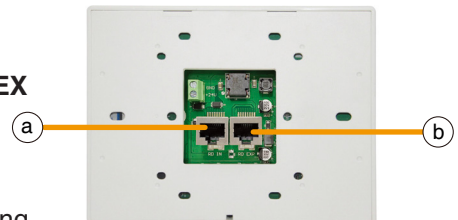

#### b. RD EXP

Connect to the RD IN port of the **M-800RCT**, **M-800RC**, **M-802RC** or **M-822IO**.

Daisy connection for additional remote controller (4 controllers max).

The maximum shielded CAT 5e cable length for daisy chain **100 meters** in total from **M-8080D** RD port to last controller.

**Wall installation instructions:**

1. First unscrew the screw on the bottom of the device with a screwdriver.
2. Fix the rear panel to the wall. Screw both ends to the wall. Check for firmness or crooked nails.
3. Insert the distributed network cable into the RD IN port, and snap the device to the rear panel. Tighten the bottom with screws.

The installation diagram is as follows:

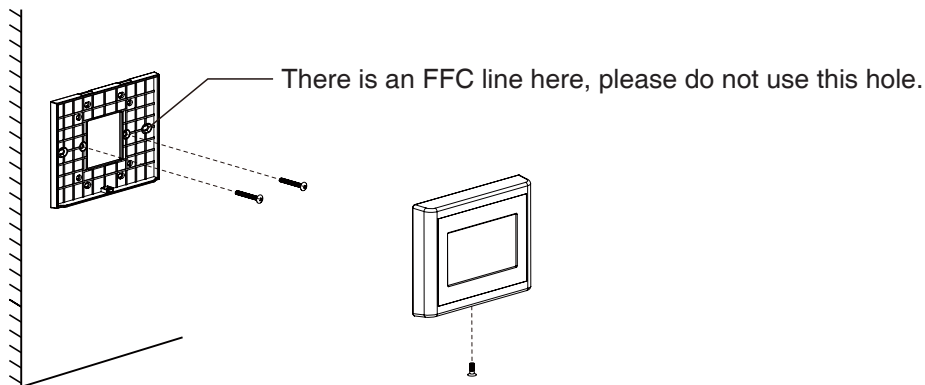

**Touch LC-Display function introduction**

The device can set up four different sub menu pages, like **Input**, **Output**, **Preset** and **System**.

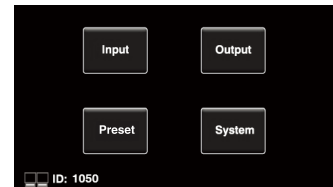

In the **Input** section, volume and mute can be adjusted and visually monitored.

1. **Channels:** Select input channel 01 - 12. Adjustable input volume.
2. **Fader:** Slide the fader to adjust the input volume.
3. **MUTE:** Mute the current channel volume.
4. **Icon & ID:** Flashing indicates normal communication and the ID number is displayed.
5. **UP:** Page up.
6. **DOWN:** Page down.
7. **MENU:** Click to return to the main page.

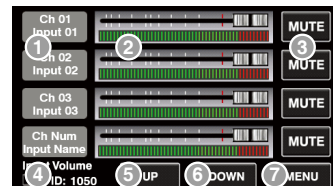

In the **Output** section, the routing function can assign any input to any output. Volume and mute can be adjusted and visually monitored.

1. **MUTE:** Mute the current output channel volume.
2. **Output channels:** Switch the setting interface of OUT 01 - OUT 12. ("Standalone System" mode). Switch the setting interface of OUT 01 - OUT 20. ("System With Dante Module" mode).
3. **Input channels:** Turn on / off IN 01 - 12. ("Standalone System" mode). Turn on / off IN 01 - 20. ("Standalone System" mode).
4. **Output Volume:** Slide the fader to adjust the output volume.
5. **Icon & ID:** Flashing indicates normal communication and the ID number is displayed.
6. **UP:** Page up.
7. **DOWN:** Page down.
8. **MENU:** Click to return to the main page.

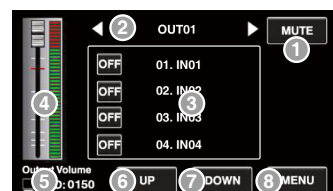

The **Preset** menu can call up setting presets memorized in the **M-8080D**.

1. **PRESET LIST:** All the presets on the **M-8080D** are displayed here.
2. **UP:** Page up.
3. **DOWN:** Page down.
4. **LOAD:** After selecting a preset (1) click to load the preset.
5. **Icon & ID:** Flashing indicates normal communication and the ID number is displayed.
6. **MENU:** Click to return to the main page.

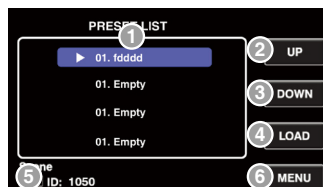

The **System** section displays the firmware version, address and device name.

1. The device name, address, firmware version, language are displayed here.
2. **Icon & ID:** Flashing indicates normal communication and the ID number is displayed.
3. Click the icon to lock immediately, and you need to enter the set password to unlock. The password can be set on the PC software. If you forget the password accidentally, you can enter “0000” to unlock it.
4. It displays the current system language.
5. **MENU:** Click to return to the main page.

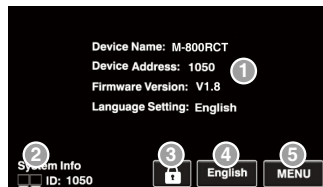

## M-800RCT Editor

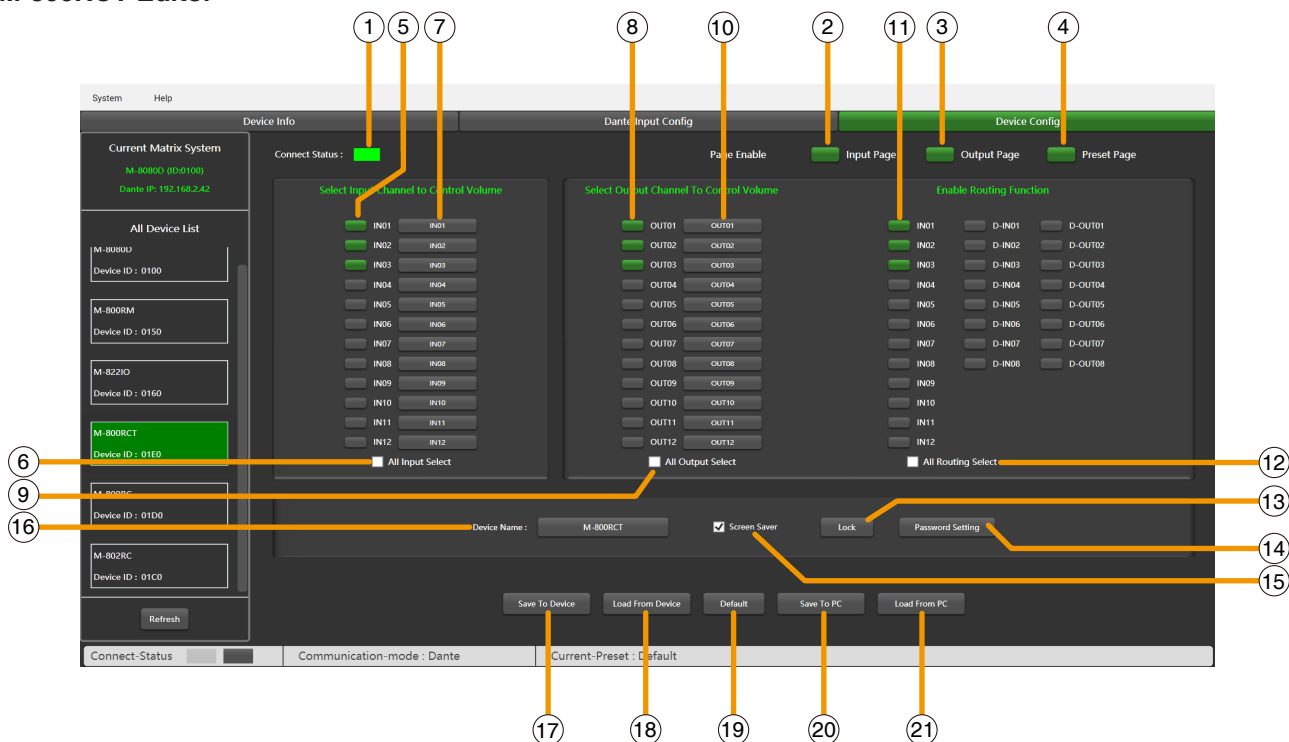

1. **Connect Status:** When the signal light shows green, it means the communication status is normal. If it shows gray, it means no communication.
2. **Input Page Enable:** After clicking enable, input page can be accessed from the Touch LC-Display. Enabled is green, disabled is gray.
3. **Output Page Enable:** After clicking enable, output page can be accessed from the Touch LC-Display. Enabled is green, disabled is gray.
4. **Preset Page Enable:** After clicking enable, preset page can be accessed from the Touch LC-Display. Enabled is green, disabled is gray.
5. **Select Input Channel to Control Volume:** Selected is green, unselected is gray.
6. **All Input Select:** Select all input channels at once.
7. **Input Channel Name:** The default name is displayed in the box, click to modify the input channel name.

- 8. Select Output Channel to Control Volume:** Selected is green, unselected is gray.
- 9. All Output Select:** Select all output channels at once.
- 10. Output Channel Name:** The default name is displayed in the box, click to modify the output channel name.
- 11. Enable Routing Function:** Click to control the routing of output channels, selected is green, unselected is gray.
- 12. All Routing Select:** Select all routes at once.
- 13. Lock / Unlock:** Click to lock the M-802RC. Click unlock and enter the password **(11)** to unlock. If you forget the password, you can use the factory password "0000" to unlock.
- 14. Password Setting:** Numbers and letters can be entered as the password.
- 15. Screen saver:** When this box is checked, the device will enter the sleep state if there is no operation for one minute.
- Note:** The factory setting is ON. In order to prolong the life of the LC-Display, it is recommended that the user set it to ON.
- 16. Device Name:** The default name is displayed in the box, click to modify the device name.
- 17. Save To Device:** After the settings are modified, they need to be saved to the device to take effect.
- 18. Load from Device:** Load presets from device to PC.
- 19. Default:** Initialize preset parameters.
- 20. Save to PC:** Save current preset to PC.
- 21. Load from PC:** Load selected preset from PC.

## 9.6. M-804EX



The **M-804EX** is a port expander featuring a star connection of the controllers. This interface is particularly useful when daisy chain between devices is not possible or when the controllers are far away from the **M-8080D**.

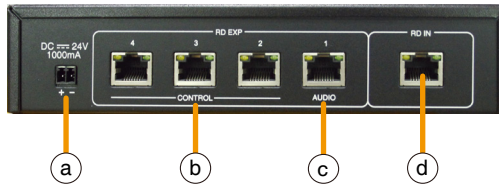

### a. 24V DC power supply

When there are too many devices connected to the RD EXP port of **M-804EX** and the POWER LED on the front panel of **M-804EX** is off, please connect an DC24V external power supply. Note that the power connection polarity.

**b. RD expansion port 2-4:** Only connect remote control devices, such as **M-800RC / M-800RCT**.

**c. RD expansion port 1:** Can connect remote control and audio transport devices, such as **M-802RC / M-822IO / M-800RM**. You can also connect remote control devices, such as **M-800RC / M-800RCT**.

**Note:** When the **M-800RC/M-800RCT** is connected to this port, the RD EXP port of the **M-800RC/M-800RCT** can be connected to the **M-802RC/M-822IO**.

**d. RD IN port:** RD connection with **M-8080D**.

### Attention:

- Each **M-8080D** RD port can support only 1 **M-804EX**. Another **M-804EX** cannot be connected via RD EXP Port.
- Each RD EXP port can support up to 4pcs **M-800RC / M-800RCT**.
- The maximum shielded CAT 5e cable length for daisy chain **100 meters** in total from M-8080D RD port to last controller.
- The braid screen or foil of the shielded CAT 5e cable must be securely connected to the metal shell of the shielded RJ45 connector.
- The RD ports do not support hot plugging, please power off the **M-8080D** before connecting.

## 9.7. M-800DT

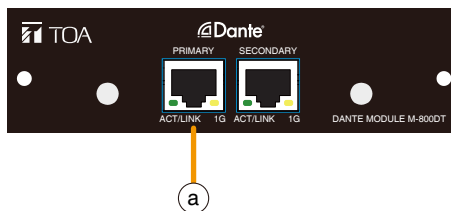

**a. LAN:** Port for the Ethernet connection, 100/1000Mbps adaptive, with DHCP function. The plug includes two LEDs, a green one indicating the good connection to the network and a yellow one indicating the good data transmission.

- If the yellow LED turns Off, there is a transmission problem. If On, with Green LED Off, the device has detected the network, but there is no connection.
- If the Green LED is on, the network connection is correct.

### Attention:

The braid screen or foil of the shielded CAT 5e cable must be securely connected to the metal shell of the shielded RJ45 connector.



## MALL

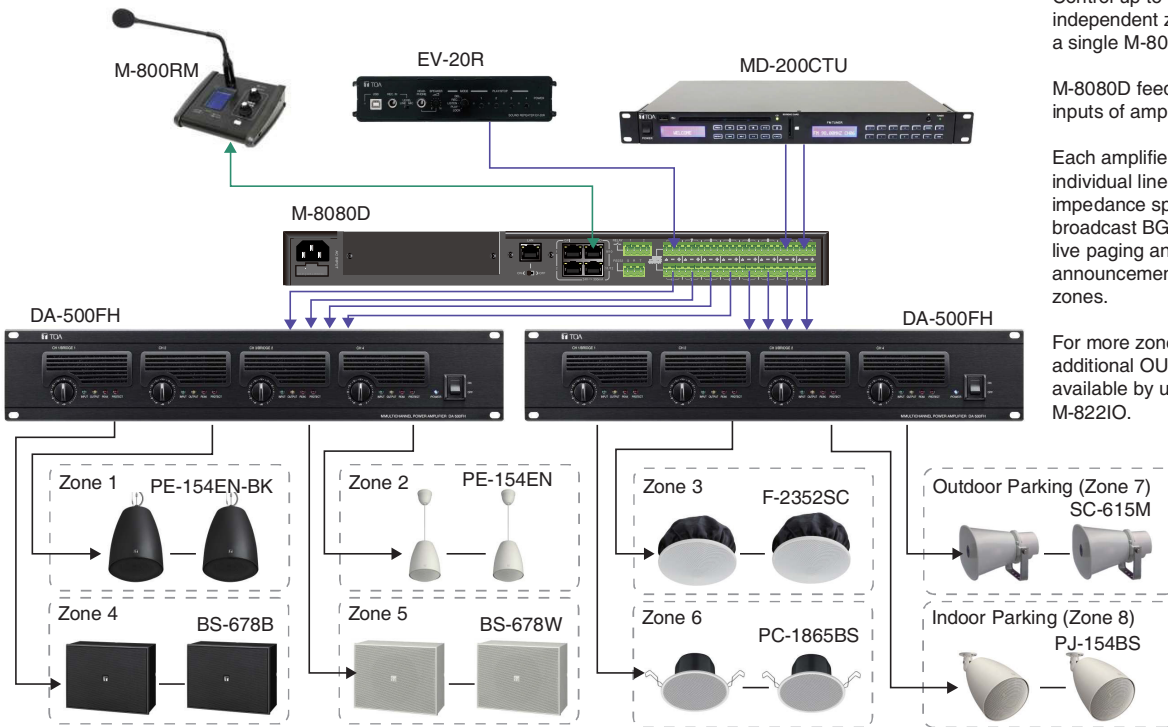

Control up to 12 independent zones with a single M-8080D

M-8080D feeds 2 x 4 analog inputs of amplifiers.

Each amplifier offers 4 individual lines of high impedance speakers to broadcast BGM program, live paging and pre-recorded announcement in separate zones.

For more zones, 2 x additional OUT are available by using a M-822IO.

## HOTEL

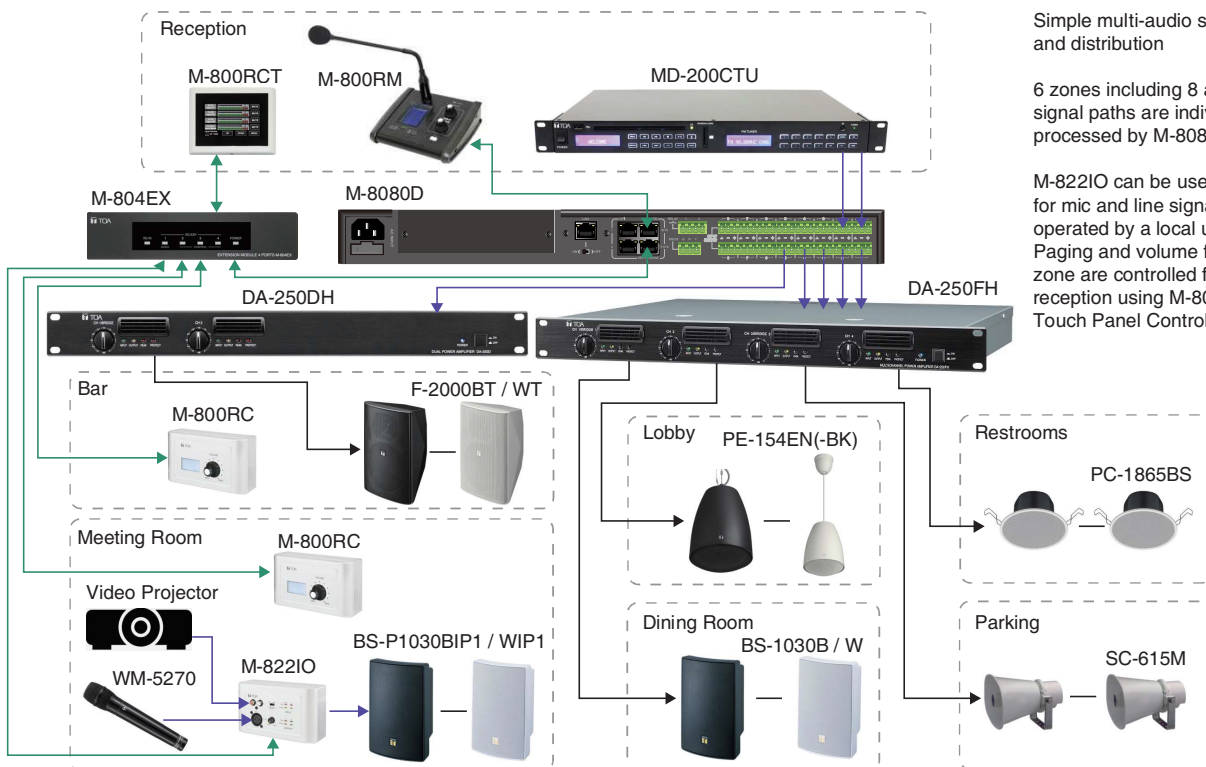

Simple multi-audio service and distribution

6 zones including 8 audio signal paths are individually processed by M-8080D.

M-822IO can be used locally for mic and line signal directly operated by a local user. Paging and volume for every zone are controlled from the reception using M-800RCT Touch Panel Controller.

# RESTAURANT / BAR

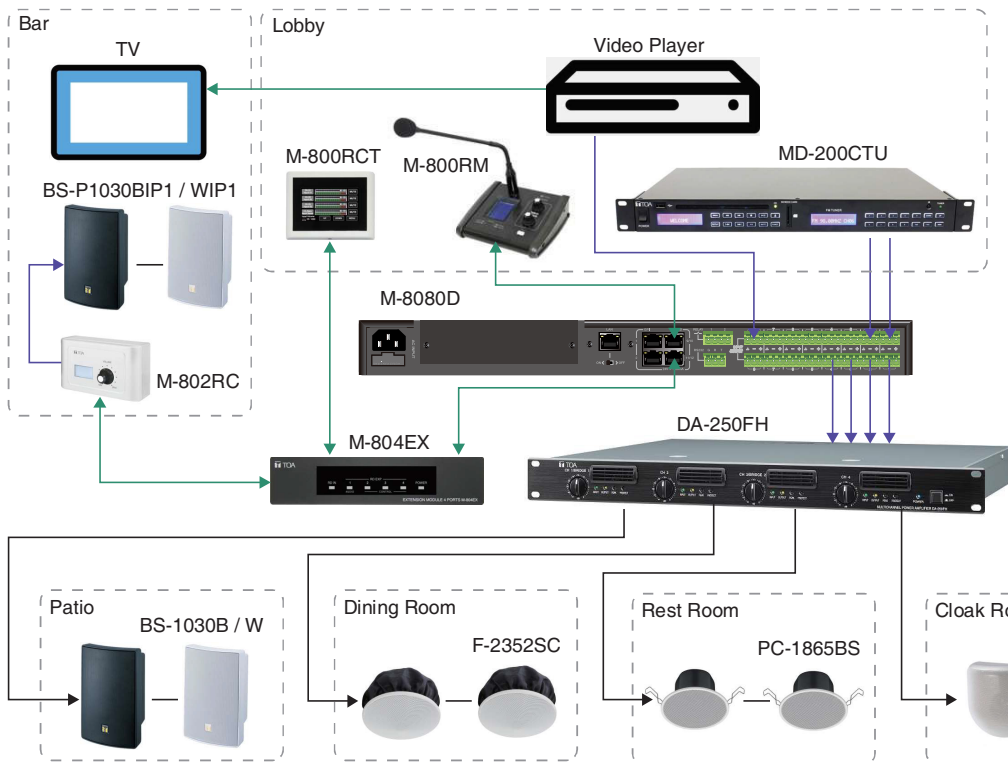

Easy and quick volume control for operators

4 analog outputs of M-8080D are used for 4 separate zones with volume controlled from the lobby.

Two additional line out come from the M-802RC remote controller using digital connection from the M-8080D. It feeds the bar area where M-802RC remote can be replaced by M-822IO In/Out interface for DJ show or Karaoke session.

# SCHOOL

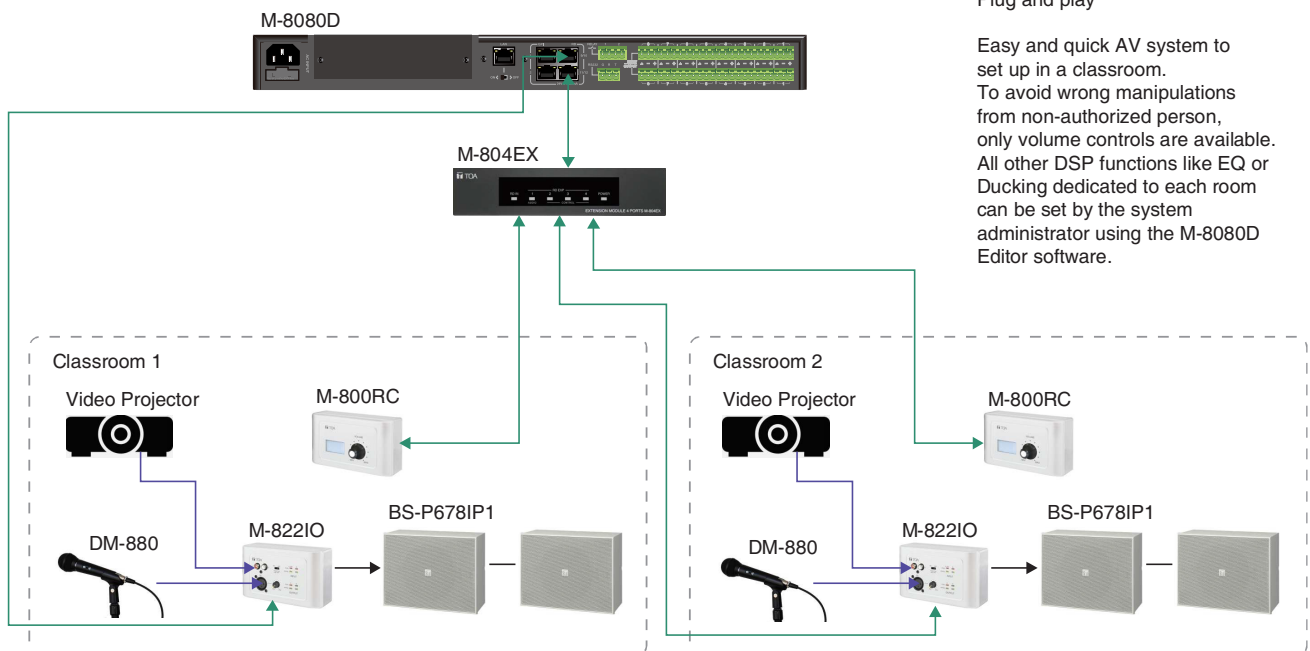

Plug and play

Easy and quick AV system to set up in a classroom. To avoid wrong manipulations from non-authorized person, only volume controls are available. All other DSP functions like EQ or Ducking dedicated to each room can be set by the system administrator using the M-8080D Editor software.

# GYM

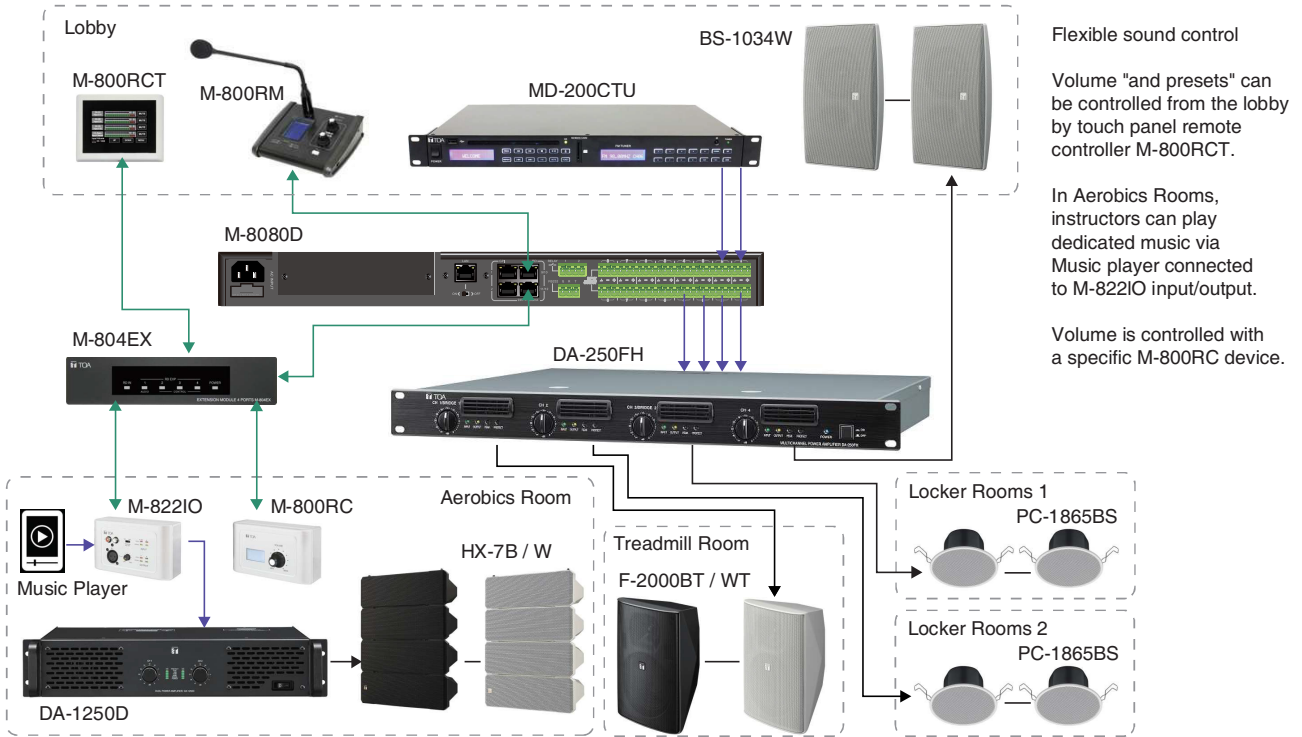

# 11. RS-232 CODES

| No | Start Byte0 (1Byte) | Start Byte1 (1Byte) | Start Byte2 (1Byte) | Length (2 Byte) | Device (2 Byte) | ID Address (High Byte)          | ID Address (Low Byte)          | Type (2 Byte) | Command (2 Byte) | Channel Local Channel : 0x01 - 0x0C<br>Network Channel : 0x0D - 0x14 (n Byte)                   | Value (n Byte)   | End Byte (1Byte) | Function                    |
|----|---------------------|---------------------|---------------------|-----------------|-----------------|---------------------------------|--------------------------------|---------------|------------------|---|--|------------------|-----------------------------|
| 1  | 0x01                | 0x20                | 0x03                | 0x00 0x10       | 0x00 0x06       | 0x01 ( High Byte of ID address) | 0x00 ( Low Byte of ID address) | 0xA5 0xE8     | 0x00 0x01        | Channel 1-12: 0x01 - 0x0C ( 1 Byte)   | Volume : 0x00 - 0xBE ( 1 Byte )  | 0x40             | Input Gain                  |
| 2  | 0x01                | 0x20                | 0x03                | 0x00 0x10       | 0x00 0x06       | 0x01 ( High Byte of ID address) | 0x00 ( Low Byte of ID address) | 0xA5 0xE8     | 0x00 0x02        | Channel 1-12: 0x01 - 0x0C ( 1 Byte)   | Phase : 0x00 - Normal , 0x01 - Invert ( 1 Byte )   | 0x40             | Input Phase                 |
| 3  | 0x01                | 0x20                | 0x03                | 0x00 0x10       | 0x00 0x06       | 0x01 ( High Byte of ID address) | 0x00 ( Low Byte of ID address) | 0xA5 0xE8     | 0x00 0x03        | Channel 1-12: 0x01 - 0x0C ( 1 Byte)   | Mute : 0x00 - Off , 0x01 - On ( 1 Byte )   | 0x40             | Input Mute                  |
| 4  | 0x01                | 0x20                | 0x03                | 0x00 0x10       | 0x00 0x06       | 0x01 ( High Byte of ID address) | 0x00 ( Low Byte of ID address) | 0xA5 0xE8     | 0x00 0x04        | Channel 1-12: 0x01 - 0x0C ( 1 Byte)   | Invalid : 0x00 ( 1 Byte )  | 0x40             | Get Input Status            |
| 5  | 0x01                | 0x20                | 0x03                | 0x00 0x13       | 0x00 0x06       | 0x01 ( High Byte of ID address) | 0x00 ( Low Byte of ID address) | 0xA5 0xE8     | 0x00 0x04        | Channel 1-12: 0x01 - 0x0C ( 1 Byte)   | Volume : 0x00 - 0xBE ( 1 Byte )<br>Phase : 0x00 - Normal , 0x01 - Invert ( 1 Byte )<br>Mute : 0x00 - Off , 0x01 - On ( 1 Byte )<br>DC48V : 0x00 - Off , 0x01 - On ( 1 Byte )   | 0x40             | Receive Input Status        |
| 6  | 0x01                | 0x20                | 0x03                | 0x00 0x10       | 0x00 0x06       | 0x01 ( High Byte of ID address) | 0x00 ( Low Byte of ID address) | 0xA5 0xE8     | 0x00 0x05        | Channel 1-12: 0x01 - 0x0C ( 1 Byte)   | Volume : 0x00 - 0xBE ( 1 Byte )  | 0x40             | Output Gain                 |
| 7  | 0x01                | 0x20                | 0x03                | 0x00 0x10       | 0x00 0x06       | 0x01 ( High Byte of ID address) | 0x00 ( Low Byte of ID address) | 0xA5 0xE8     | 0x00 0x06        | Channel 1-12: 0x01 - 0x0C ( 1 Byte)   | Phase : 0x00 - Normal , 0x01 - Invert ( 1 Byte )   | 0x40             | Output Phase                |
| 8  | 0x01                | 0x20                | 0x03                | 0x00 0x10       | 0x00 0x06       | 0x01 ( High Byte of ID address) | 0x00 ( Low Byte of ID address) | 0xA5 0xE8     | 0x00 0x07        | Channel 1-12: 0x01 - 0x0C ( 1 Byte)   | Mute : 0x00 - Off , 0x01 - On ( 1 Byte )   | 0x40             | Output Mute                 |
| 9  | 0x01                | 0x20                | 0x03                | 0x00 0x10       | 0x00 0x06       | 0x01 ( High Byte of ID address) | 0x00 ( Low Byte of ID address) | 0xA5 0xE8     | 0x00 0x08        | Channel 1-12: 0x01 - 0x0C ( 1 Byte)   | Invalid : 0x00 ( 1 Byte )  | 0x40             | Get Output Status           |
| 10 | 0x01                | 0x20                | 0x03                | 0x00 0x13       | 0x00 0x06       | 0x01 ( High Byte of ID address) | 0x00 ( Low Byte of ID address) | 0xA5 0xE8     | 0x00 0x08        | Channel 1-12: 0x01 - 0x0C ( 1 Byte)   | Volume : 0x00 - 0xBE ( 1 Byte )<br>Phase : 0x00 - Normal , 0x01 - Invert ( 1 Byte )<br>Mute : 0x00 - Off , 0x01 - On ( 1 Byte )<br>Invalid : 0x00 ( 1 Byte )   | 0x40             | Receive Output Status       |
| 11 | 0x01                | 0x20                | 0x03                | 0x00 0x11       | 0x00 0x06       | 0x01 ( High Byte of ID address) | 0x00 ( Low Byte of ID address) | 0xA5 0xE8     | 0x00 0x09        | Matrix Output Channel : 0x01 - 0x14 ( 1 Byte )<br>Matrix Input Channel : 0x01 - 0x14 ( 1 Byte ) | Routing : 0x00 - Off , 0x01 - On ( 1 Byte )  | 0x40             | Matrix Mixer                |
| 12 | 0x01                | 0x20                | 0x03                | 0x00 0x10       | 0x00 0x06       | 0x01 ( High Byte of ID address) | 0x00 ( Low Byte of ID address) | 0xA5 0xE8     | 0x00 0x0A        | Matrix Output Channel : 0x01 - 0x14 ( 1 Byte )  | Invalid : 0x00 ( 1 Byte )  | 0x40             | Get Matrix Mixer Status     |
| 13 | 0x01                | 0x20                | 0x03                | 0x00 0x23       | 0x00 0x06       | 0x01 ( High Byte of ID address) | 0x00 ( Low Byte of ID address) | 0xA5 0xE8     | 0x00 0x0A        | Matrix Output Channel : 0x01 - 0x14 ( 1 Byte )  | Matrix Local Input 01 : 0x00 - Off , 0x01 - On ( 1 Byte )<br>Matrix Local Input 02 : 0x00 - Off , 0x01 - On ( 1 Byte )<br>Matrix Local Input 03 : 0x00 - Off , 0x01 - On ( 1 Byte )<br>Matrix Local Input 04 : 0x00 - Off , 0x01 - On ( 1 Byte )<br>Matrix Local Input 05 : 0x00 - Off , 0x01 - On ( 1 Byte )<br>Matrix Local Input 06 : 0x00 - Off , 0x01 - On ( 1 Byte )<br>Matrix Local Input 07 : 0x00 - Off , 0x01 - On ( 1 Byte )<br>Matrix Local Input 08 : 0x00 - Off , 0x01 - On ( 1 Byte )<br>Matrix Local Input 09 : 0x00 - Off , 0x01 - On ( 1 Byte )<br>Matrix Local Input 10 : 0x00 - Off , 0x01 - On ( 1 Byte )<br>Matrix Local Input 11 : 0x00 - Off , 0x01 - On ( 1 Byte )<br>Matrix Local Input 12 : 0x00 - Off , 0x01 - On ( 1 Byte )<br>Matrix Network Input 01 : 0x00 - Off , 0x01 - On ( 1 Byte )<br>Matrix Network Input 02 : 0x00 - Off , 0x01 - On ( 1 Byte )<br>Matrix Network Input 03 : 0x00 - Off , 0x01 - On ( 1 Byte )<br>Matrix Network Input 04 : 0x00 - Off , 0x01 - On ( 1 Byte )<br>Matrix Network Input 05 : 0x00 - Off , 0x01 - On ( 1 Byte )<br>Matrix Network Input 06 : 0x00 - Off , 0x01 - On ( 1 Byte )<br>Matrix Network Input 07 : 0x00 - Off , 0x01 - On ( 1 Byte )<br>Matrix Network Input 08 : 0x00 - Off , 0x01 - On ( 1 Byte ) | 0x40             | Receive Matrix Mixer Status |
| 14 | 0x01                | 0x20                | 0x03                | 0x00 0x10       | 0x00 0x06       | 0x01 ( High Byte of ID address) | 0x00 ( Low Byte of ID address) | 0xA5 0xE8     | 0x00 0x0B        | Channel 1-12: 0x01 - 0x0C ( 1 Byte)   | Invalid : 0x00 ( 1 Byte )  | 0x40             | Input Gain Up , Step=1dB    |
| 15 | 0x01                | 0x20                | 0x03                | 0x00 0x10       | 0x00 0x06       | 0x01 ( High Byte of ID address) | 0x00 ( Low Byte of ID address) | 0xA5 0xE8     | 0x00 0x0C        | Channel 1-12: 0x01 - 0x0C ( 1 Byte)   | Invalid : 0x00 ( 1 Byte )  | 0x40             | Input Gain Down , Step=1dB  |
| 16 | 0x01                | 0x20                | 0x03                | 0x00 0x10       | 0x00 0x06       | 0x01 ( High Byte of ID address) | 0x00 ( Low Byte of ID address) | 0xA5 0xE8     | 0x00 0x0D        | Channel 1-12: 0x01 - 0x0C ( 1 Byte)   | Invalid : 0x00 ( 1 Byte )  | 0x40             | Output Gain Up , Step=1dB   |
| 17 | 0x01                | 0x20                | 0x03                | 0x00 0x10       | 0x00 0x06       | 0x01 ( High Byte of ID address) | 0x00 ( Low Byte of ID address) | 0xA5 0xE8     | 0x00 0x0E        | Channel 1-12: 0x01 - 0x0C ( 1 Byte)   | Invalid : 0x00 ( 1 Byte )  | 0x40             | Output Gain Down , Step=1dB |
| 18 | 0x01                | 0x20                | 0x03                | 0x00 0x10       | 0x00 0x06       | 0x01 ( High Byte of ID address) | 0x00 ( Low Byte of ID address) | 0xA5 0xE8     | 0x00 0x0F        | Channel 1-12: 0x01 - 0x08 ( 1 Byte)   | DC-48V : 0x00 - Off , 0x01 - On ( 1 Byte )   | 0x40             | Input DC-48V                |
| 19 | 0x01                | 0x20                | 0x03                | 0x00 0x10       | 0x00 0x06       | 0x01 ( High Byte of ID address) | 0x00 ( Low Byte of ID address) | 0xA5 0xE8     | 0x00 0x10        | Relay 1 / Relay 2 : 0x01 / 0x02 ( 1 Byte )  | IN1-8, Paging, None : 0x00 - 0x09 ( 1 Byte )   | 0x40             | Relay Control               |
| 20 | 0x01                | 0x20                | 0x03                | 0x00 0x10       | 0x00 0x06       | 0x01 ( High Byte of ID address) | 0x00 ( Low Byte of ID address) | 0xA5 0xE8     | 0x00 0x11        | Invalid : 0x00 ( 1 Byte )   | Invalid : 0x00 ( 1 Byte )  | 0x40             | Get Relay Status            |
| 21 | 0x01                | 0x20                | 0x03                | 0x00 0x10       | 0x00 0x06       | 0x01 ( High Byte of ID address) | 0x00 ( Low Byte of ID address) | 0xA5 0xE8     | 0x00 0x11        | Relay 01 ( IN1-8, Paging, None ) :<br>0x00 - 0x09 ( 1 Byte )                                    | Relay 02 ( IN1-8, Paging, None ) :<br>0x00 - 0x09 ( 1 Byte )   | 0x40             | Receive Relay Status        |
| 22 | 0x01                | 0x20                | 0x03                | 0x00 0x1F       | 0x00 0x06       | 0x01 ( High Byte of ID address) | 0x00 ( Low Byte of ID address) | 0xA5 0xE8     | 0x00 0x12        | 16 Chars Device Name - ASCII Code ( 16 Byte )   | Invalid : 0x00 ( 1 Byte )  | 0x40             | Modify Device Name          |
| 23 | 0x01                | 0x20                | 0x03                | 0x00 0x10       | 0x00 0x06       | 0x01 ( High Byte of ID address) | 0x00 ( Low Byte of ID address) | 0xA5 0xE8     | 0x00 0x13        | Invalid : 0x00 ( 1 Byte )   | Invalid : 0x00 ( 1 Byte )  | 0x40             | Get Device information      |
| 24 | 0x01                | 0x20                | 0x03                | 0x00 0x1F       | 0x00 0x06       | 0x01 ( High Byte of ID address) | 0x00 ( Low Byte of ID address) | 0xA5 0xE8     | 0x00 0x13        | 16 Chars Device Name - ASCII Code ( 16 Byte )   | Firmware Version : 0x10 - 0x99   | 0x40             | Receive Device information  |
| 25 | 0x01                | 0x20                | 0x03                | 0x00 0x10       | 0x00 0x06       | 0x01 ( High Byte of ID address) | 0x00 ( Low Byte of ID address) | 0xA5 0xE8     | 0x00 0x14        | Preset number : 0x01 - 0x18 ( 1 Byte )  | Invalid : 0x00 ( 1 Byte )  | 0x40             | Recall Preset               |

**Note:**

RS-232 Baudrate=9600

ID address example: if M-8080D ID=0100 then High Byte of ID address=0x01 and Low Byte of ID address=0x00.

Dante channels cannot be controlled with RS-232.

**M-8080D Example Commands**

Example which mutes Channel 6 of a device with the ID-0200:

0x01 0x20 0x03 0x00 0x10 0x00 0x06 0x02 0x00 0xA5 0xE8 0x00 0x03 0x06 0x01 0x40

Next example changes the Output Gain of Channel 3 of a device with ID-0100:

0x01 0x20 0x03 0x00 0x10 0x00 0x06 0x01 0x00 0xA5 0xE8 0x00 0x05 0x03 0xBE 0x40

## 12. SPECIFICATIONS

### 12.1. 8x8 DIGITAL MATRIX MIXER M-8080D

|                            |   |
|----------------------------|---|
| Power Source               | 100-240 V AC, 50/60 Hz  |
| Power Consumption          | 40 W  |
| Audio Input                | Input 1 - 8 : -48 to 0 dBV, 6.8 kΩ, electronic balanced, removable terminal block (3 pins x 8)  |
| Audio Output               | Output 1 - 8 : 0 dBV, 1.8 kΩ, Maximum output 20 dBu(7.75V), electronic balanced, removable terminal block (3 pins x 8)  |
| Frequency Response         | 20 - 20,000 Hz, ±3 dB   |
| Total Harmonic Distortion  | 0.01 %  |
| S/N Ratio                  | Over 105 dB (A weighted)  |
| Crosstalk                  | Over 79 dB (A weighted)   |
| Phantom Power              | +48 VDC, switchable, Inputs 1 - 8   |
| Control input              | GPI 1 - 2 : no-voltage contact input, open voltage:1.5V DC, short-circuit current: under 3 mA, RJ45 Connector x 2   |
| Control output             | Relay 1 - 2 : withstand voltage: 24V DC, control current: Under 500 mA, removable terminal block(4 pins)  |
| RD port                    | RD 9 - 12 : transmits and receives AES3 digital audio plus control data connect remote devices such as M-822IO, M-800RC, M-802RC, M-800RCT and M-800RM, maximum cable length is 100 meters, RJ45 Connector x 2  |
| Equalizer/Filter           | 5 band EQ (LPF and HPF) for IN and 8 band EQ (LPF and HPF) for OUT<br>Parametric Equalizer: 19.7 - 20,160 Hz, range: ±18 dB, Q: 0.4 - 128, Type: peak/low/high Filter:<br>High-pass Filter: 19.7 - 20,160 Hz, Type: Butterworth 6, 12, 18, 24, 30, 36, 42, 48 dB; Bessel 6, 12, 18, 24, 30, 36, 42, 48 dB; Linkwitz 12, 24, 36, 48 dB<br>Low-pass Filter: 19.7 - 20,160 Hz, Type: Butterworth 6, 12, 18, 24, 30, 36, 42, 48 dB; Bessel 6, 12, 18, 24, 30, 36, 42, 48 dB; Linkwitz 12, 24, 36, 48 dB |
| Gate                       | Threshold: -80 to +20 dB in 1 dB steps<br>Ratio: 1:1, 1.2:1, 1.3:1, 1.5:1, 1.7:1, 2.0:1, 2.2:1, 2.3:1, 2.5:1, 3.0:1, 3.5:1, 4.0:1, 4.5:1, 5.0:1, 5.5:1, 6.0:1, 6.5:1, 7.0:1, 7.5:1, 8.0:1, 8.5:1, 9.0:1, 9.5:1, 10.0:1, gate<br>Attack: 10 - 150 ms<br>Release: 10 ms - 1 s   |
| Compressor                 | Threshold: -30 to +20 dB in 1 dB steps<br>Ratio: 1:1, 1.2:1, 1.3:1, 1.5:1, 1.7:1, 2.0:1, 2.2:1, 2.3:1, 2.5:1, 3.0:1, 3.5:1, 4.0:1, 4.5:1, 5.0:1, 5.5:1, 6.0:1, 6.5:1, 7.0:1, 7.5:1, 8.0:1, 8.5:1, 9.0:1, 9.5:1, 10.0:1, limit<br>Attack: 10 - 150 ms<br>Release: 10 ms - 1 s  |
| Ducker                     | Level: 0-15<br>Threshold: -80 to 0 dB in 1 dB steps<br>Depth: -60 to 0 dB in 1 dB steps<br>Activation: 10 ms - 6 s  |
| Feedback compression (FBC) | Mode: Speech / Music<br>Filter release: fast / mid / low<br>FBC type: dynamic Filters / static Filters  |
| Auto mixer                 | Activation: 10 ms - 6 s   |
| Delay                      | Delay time: 0 - 1361.2916 ms  |
| A/D Converter              | 24 bit  |
| Sampling Frequency         | 48 kHz  |
| Display                    | LC-Display<br>Displays device information: name, firmware version, ID, communication status   |
| Indicators                 | Input: Analog Signal(Green)x8, Analog Peak(Red)x8, RD Signal(Green)x4, RD Peak(Red)x4<br>Output: Analog Signal(Green)x8, Analog Peak(Red)x8, RD Signal(Green)x4, RD Peak(Red)x4<br>Status: Fault(Red)x1, Comm(Green)x1, Power(Blue)x1   |
| Operating Temperature      | 0 °C to +40 °C (32 °F to 104 °F)  |
| Operating Humidity         | 90 % RH or less (no condensation)   |
| Finish                     | Panel: Aluminum, black<br>Case: Surface-treated steel plate, black, paint   |
| Dimensions                 | 483 (W) x 44.2 (H) x 259 (D) mm (19.02" x 1.74" x 10.18")   |
| Weight                     | 4.58 kg   |
| Accessory                  | Power cord (2 m)...2, CAT5 cable (2 m)...1, Removable terminal block(4 pins)...1, Removable terminal block(3 pins)...17   |
| Option                     | M-804EX, M-822IO, M-800RC, M-802RC, M-800RCT, M-800RM, M-800DT  |

## 12.2. REMOTE MICROPHONE M-800RM

|                           |   |
|---------------------------|---|
| Power Source              | 24V DC (Powered by M-8080D or M-804EX)  |
| Audio Output              | 0 dBV, electronic balanced, RJ45 Connector  |
| Gooseneck Microphone      | Unidirectional electret condenser microphone  |
| Frequency Response        | 20 - 20,000 Hz, $\pm 3$ dB  |
| Total Harmonic Distortion | 0.01 %  |
| RD port                   | Transmits and receives AES3 digital audio plus control data cable length is 100 meters, Connect to M-8080D or M-804EX, RJ45 Connector |
| USB port                  | Load WAV / MP3 files for chimes sound   |
| Volume Control            | Microphone volume control and all zone selector   |
| Zone selector             | Can address 1 to 64 different zones   |
| Display                   | LC-Display<br>Displays device information: ID, volume, zone selector  |
| Indicators                | Input Signal (Green) x 1, Input Peak (Red) x 1, Busy (Red) x 1, Comm (Green) x 1  |
| Operating Temperature     | 0 °C to +40 °C (32 °F to 104 °F)  |
| Operating Humidity        | 90 % RH or less (no condensation)   |
| Finish                    | Case: Surface-treated steel plate, black, paint   |
| Dimensions                | 176 (W) x 61.8 (H) x 162.4 (D) mm (6.93" x 2.43" x 6.40") (gooseneck microphone excluded)   |
| Weight                    | 0.8 kg  |

### 12.3. REMOTE AUDIO CONTROL PANEL M-800RC

| Model no.             | M-800RC   | M-800RCB                          |
|-----------------------|---|-----------------------------------|
| Power Source          | 24V DC (Powered by M-8080D or M-804EX)  |                                   |
| RD IN                 | Transmits and receives AES3 digital audio plus control data<br>Connect to M-8080D, M-804EX, M-800RCT or M-800RC for daisy chain, RJ45 Connector |                                   |
| RD EXP                | Transmits and receives control data<br>Connect to M-800RC, M-802RC or M-822IO, RJ45 Connector   |                                   |
| Control               | Volume / routing  |                                   |
| Display               | LC-Display<br>Displays device information : ID, Volume, communication status  |                                   |
| Operating Temperature | 0 °C to +40 °C (32 °F to 104 °F)  |                                   |
| Operating Humidity    | 90 % RH or less (no condensation)   |                                   |
| Finish                | Panel: Polycarbonate + ABS, white<br>(RAL9016 or equivalent)  | Panel: Polycarbonate + ABS, black |
| Dimensions            | 147 (W) x 86 (H) x 65 (D) mm (5.79" x 3.39" x 2.56")  |                                   |
| Weight                | 0.3 kg  |                                   |
| Accessory             | Front cover...1, Wall mounting screw (4 x 30)...4, Box mounting screw (4 x 20)...4,<br>Plastic anchor...4                                       |                                   |

### 12.4. REMOTE AUDIO CONTROL PANEL WITH AUDIO OUT M-802RC

| Model no.                 | M-802RC   | M-802RCB                          |
|---------------------------|---|-----------------------------------|
| Power Source              | 24V DC (Powered by M-8080D or M-804EX)  |                                   |
| Audio Output              | Line output 1 - 2 : 0 dBV, 1.8 kΩ, Maximum output 20 dBu (7.75 V) , electronic balanced,<br>screw terminal (3 pins x 2)         |                                   |
| RD IN                     | Transmits and receives AES3 digital audio plus control data<br>Connect to M-8080D, M-804EX, M-800RCT or M-800RC, RJ45 connector |                                   |
| Frequency Response        | 20 - 20,000 Hz, ±3 dB   |                                   |
| Total Harmonic Distortion | 0.01 %  |                                   |
| S/N Ratio                 | Over 105 dB (A weighted)  |                                   |
| Crosstalk                 | Over 79 dB (A weighted)   |                                   |
| Control                   | Volume / routing  |                                   |
| Display                   | LC-Display<br>Displays device information : ID, Volume, communication status  |                                   |
| Operating Temperature     | 0 °C to +40 °C (32 °F to 104 °F)  |                                   |
| Operating Humidity        | 90 % RH or less (no condensation)   |                                   |
| Finish                    | Panel: Polycarbonate + ABS, white<br>(RAL9016 or equivalent)  | Panel: Polycarbonate + ABS, black |
| Dimensions                | 147 (W) x 86 (H) x 65 (D) mm (5.79" x 3.39" x 2.56")  |                                   |
| Weight                    | 0.3 kg  |                                   |
| Accessory                 | Front cover...1, Wall mounting screw (4 x 30)...4, Box mounting screw (4 x 20)...4,<br>Plastic anchor...4                       |                                   |

## 12.5. REMOTE AUDIO INPUT OUTPUT PANEL M-822IO

| Model no.                 | M-822IO   | M-822IOB                          |
|---------------------------|---|-----------------------------------|
| Power Source              | 24V DC (Powered by M-8080D or M-804EX)  |                                   |
| Audio Input               | MIC input : -48 dBV, 5.1 kΩ, electronic balanced, XLR connector<br>Line input A - B : 0 dBV, 5.1 kΩ, unbalanced, RCA pin jack   |                                   |
| Audio Output              | Line output 1 - 2 : 0 dBV, 1.8 kΩ , maximum output 20 dBu (7.75 V) , electronic balanced, screw terminal (3 pins x 2)           |                                   |
| Frequency Response        | 20 - 20,000 Hz, ±3 dB   |                                   |
| Total Harmonic Distortion | 0.01 %  |                                   |
| S/N Ratio                 | Over 105 dB (A weighted)  |                                   |
| Crosstalk                 | Over 79 dB (A weighted)   |                                   |
| Phantom Power             | +48 VDC, switchable, MIC input  |                                   |
| RD IN                     | Transmits and receives AES3 digital audio plus control data<br>Connect to M-8080D, M-804EX, M-800RCT or M-800RC, RJ45 connector |                                   |
| A/D Converter             | 24 bit  |                                   |
| Sampling Frequency        | 48 kHz  |                                   |
| Indicators                | Input: Signal (Green) x 2, Peak (Red) x 2<br>Output: Signal (Green) x 2, Peak (Red) x 2   |                                   |
| Operating Temperature     | 0 °C to +40 °C (32 °F to 104 °F)  |                                   |
| Operating Humidity        | 90 % RH or less (no condensation)   |                                   |
| Finish                    | Panel: Polycarbonate + ABS, white (RAL9016 or equivalent)   | Panel: Polycarbonate + ABS, black |
| Dimensions                | 147 (W) x 86 (H) x 52 (D) mm (5.79" x 3.39" x 2.05")  |                                   |
| Weight                    | 0.3 kg  |                                   |
| Accessory                 | Front cover...1, Wall mounting screw (4 x 30)...4, Box mounting screw (4 x 20)...4, Plastic anchor...4                          |                                   |

## 12.6. REMOTE AUDIO CONTROL PANEL WITH TOUCH DISPLAY M-800RCT

| Model no.             | M-800RCT   | M-800RCTB                         |
|-----------------------|--|-----------------------------------|
| Power Source          | 24V DC (Powered by M-8080D or M-804EX)   |                                   |
| RD IN                 | Transmits and receives AES3 digital audio plus control data<br>Connect to M-8080D, M-804EX or M-800RCT for daisy chain, RJ45 Connector |                                   |
| RD EXP                | Transmits and receives control data<br>Connect to M-800RCT, M-800RC, M-802RC or M-822IO, RJ45 Connector                                |                                   |
| Display               | LC-Display<br>Displays device information : ID, Volume, preset, communication status, system, etc.                                     |                                   |
| Operating Temperature | 0 °C to +40 °C (32 °F to 104 °F)   |                                   |
| Operating Humidity    | 90 % RH or less (no condensation)  |                                   |
| Finish                | Panel: Polycarbonate + ABS, white (RAL9016 or equivalent)  | Panel: Polycarbonate + ABS, black |
| Dimensions            | 150 (W) x 115 (H) x 28 (D) mm (5.90" x 4.53" x 1.10")  |                                   |
| Weight                | 0.28 kg  |                                   |
| Accessory             | Wall mounting screw (4 x 30)...4, Box mounting screw (4 x 20)...4, Plastic anchor...4  |                                   |

## 12.7. EXTENSION MODULE 4 PORTS M-804EX

|                       |   |
|-----------------------|---|
| Power Source          | 24V DC (Powered by M-8080D or DC24V external power supply)  |
| RD IN                 | Transmits and receives AES3 digital audio plus control data<br>Connect to M-8080D, RJ45 Connector   |
| RD EXP                | Port 1: transmits and receives AES3 digital audio plus control data<br>connect to M-800RM, M-800RCT, M-800RC, M-802RC or M-822IO, RJ45 Connector<br>maximum cable length 100 meters in total from M-8080D RD port to last controller<br>Port 2-4: transmits and receives control data<br>connect to M-800RCT or M-800RC, RJ45 Connector<br>maximum cable length 100 meters in total from M-8080D RD port to last controller |
| Indicators            | RD in(Green) x 1, RD exp audio(Green) x 1, RD exp control(Green) x 3, Power(Red) x 1  |
| Operating Temperature | 0 °C to +40 °C (32 °F to 104 °F)  |
| Operating Humidity    | 90 % RH or less (no condensation)   |
| Finish                | Panel: Aluminum, black<br>Case: Surface-treated steel plate, black, paint   |
| Dimensions            | 196.2 (W) x 44.2 (H) x 133 (D) mm (7.72" x 1.74" x 5.24")   |
| Weight                | 0.92 kg   |
| Accessory             | Removable terminal plug(2p)...1, CAT.5e cable(2m)...1, Plastic foot pad...4   |

## 12.8. DANTE MODULE M-800DT

|                         |   |
|-------------------------|---|
| Power Source            | 5V DC (Powered by M-8080D)                                  |
| Audio Channels          | In: 8 channels<br>Out: 8 channels                           |
| Digital Audio Formats   | TDM, I2S  |
| Audio Transport Formats | Dante Audio over IP   |
| Control Interfaces      | SPI Master and Slave  |
| Network                 | RGMI/MII  |
| Operating Temperature   | 0 °C to +40 °C (32 °F to 104 °F)                            |
| Operating Humidity      | 90 % RH or less (no condensation)                           |
| Finish                  | Panel: Surface-treated steel plate, black, paint            |
| Dimensions              | 122.2 (W) x 33.5 (H) x 119.5 (D) mm (4.81" x 1.32" x 4.70") |
| Weight                  | 118 g   |
| Accessory               | Mounting screw (3 x 6) ...2                                 |

### احتياطات تتعلق بنواحي السلامة

- يجب التأكد، قبل التركيب أو الاستخدام، من قراءة كافة التعليمات التي من شأنها أن تضمن استخداماً آمناً وصحيحاً.
- ينبغي التأكد من إتباع كافة تعليمات الحبطة، والتي تشمل تحذيرات هامة واحتياطات تخص السلامة أو أياً منهما.
- يفضل الاحتفاظ بهذا الكتيب عقب قراءته في متناول اليد للرجوع إليه لاحقاً.
- نوه بأن هذا الكتيب يضم احتياطات تتعلق بالسلامة قد لا تنطبق على المنتجات الخاصة بك.

رمز السلامة والأعراف المتفق عليها بشأن الرسائل تستخدم رموز السلامة، والرسائل المذكورة أدناه في هذا الكتيب لمنع الإصابات الجسدية وتلف الملكية، التي تنشأ عن سوء التداول. وينبغي عليك، قبل تشغيل منتجك، أن تبدأ بقراءة هذا الكتيب، وفهم رموز السلامة والرسائل حتى تكون على وعي تام بمخاطر السلامة المحتملة.



**احذر**

المؤشرات والمواقف المحتملة التي تشكل خطورة، التي تؤدي إلى الوفاة أو الإصابات الشخصية الخطيرة في حالة إساءة الاستخدام.



**احترس**

المؤشرات والمواقف المحتملة التي تشكل خطورة، التي تؤدي إلى إصابات شخصية تتراوح ما بين متوسطة وطفيفة، بالإضافة إلى إلحاق الضرر بالعقار، أو أياً منهما.



**احذر**

#### عند تركيب الوحدة

- لا تعرض الوحدة لمياه الأمطار، أو للعوامل البيئية، التي من شأنها أن تبطل هذه الوحدة بالمياه أو بالسوائل، إذ ينتج عن هذا التصرف نشوب الحرائق أو الصدمات الكهربائية.
- استخدام الوحدة بالجهد الكهربائي الموضح في هذه الوحدة. وقد يؤدي استخدام جهد كهربائي أعلى من المحدد لهذه الوحدة إلى نشوب الحرائق، والصدمات الكهربائية.
- لا تقم بأي قطع أو ثني، وإلا سيتم إلحاق الضرر أو تعديل وصلات الدائرة الكهربائية لتقويم التيار. وينبغي، بالإضافة إلى ذلك تجنب استخدام وصلات الدائرة الكهربائية لتقويم التيار بالقرب من سخانات المياه، ولاتضع أشياء ثقيلة الوزن – بما في ذلك الوحدة ذاتها – على وصلة التيار، إذ قد يؤدي هذا إلى نشوب الحرائق، أو الصدمات الكهربائية.
- ينبغي التأكد من إستبدال غطاء طرف الوحدة عقب إنتهاء التوصيل، لأن الجهد الذي يصل حتى 100 فولت يطبق على أطراف السماعة ذات المعاقلة العالية، لا تقم بلمس هذه الاطراف حتى لا تتعرض للصدمات الكهربائية.
- تأكد من أن التوصيل الأرضي يتم عن طريق استخدام طرف التأريض الامن لتجنب الصدمات الكهربائية. واحذر أن يكون التوصيل الأرضي عن طريق مواسير الغاز، إذ يؤدي ذلك إلى حدوث كوارث محققة.
- تجنب تركيب، أو صب الوحدة في أماكن غير ثابتة، كالتركيب على طاولة أيلة للسقوط، أو على سطح مائل. وقد يؤدي ذلك إلى سقوط الوحدة و يؤدي أيضاً إلى التعرض لإصابات شخصية وإلحاق الضرر بالعقار.
- لا تقم بتركيب الوحدة في الأماكن التالية لتفادي وقوع حوادث أو إصابات شخصية:
  - الأماكن التي تعوق قيادة السيارات.
  - الأماكن التي يمكن للوحدة فيها أن تضرب بعنف جسدك، أو تعلق بملابسك عند ركوب السيارة أو النزول منها.
  - الأماكن التي تعوق فتح الوسادة الهوائية.
- حتى يتسنى تفادي صواعق البرق، ينبغي تركيب الوحدة على بعد خمسة أمتار على الأقل من قضيب البرق، وتكون في حدود نطاق وقائي (بزاوية 45 °) من موصل البرق. التي قد تؤدي الصواعق البرقية إلى نشوب الحرائق، أو الصدمات الكهربائية، أو الإصابات الشخصية.
- ينصح بإسناد كافة أعمال التركيب إلى الوكيل الذي تم شراء السماعات منه. يتطلب تركيب السماعات في مجال الطيران الإلمام الواسع بالمعلومات والخبرة الفنية الكافية. وقد تسقط السماعة إذا تم تركيبها بطريقة خاطئة، الأمر الذي قد يؤدي إلى الإصابة الشخصية.
- تحذيرات حول التعليق
  - تأكد من إتباع التعليمات المذكورة أدناه، وإلا فإن الأسلاك والأربطة المعلقة قد تسقط، أو تنزع فجأة مما يؤدي إلى سقوط السماعة، والتسبب في إصابات جسدية.
  - تأكد من أن الأسلاك والأربطة المعلقة مثبتة بالقدر الكافي الذي يتحمل وزن السماعة.
  - لا بد أن تكون موصلات الأسلاك المعلقة والأربطة موصلة بصورة آمنة مع موصلات السماعة.
  - يجب أن تكون جميع الأجزاء والمكونات (ومنها على سبيل المثال، الأغلفة، والأجزاء المعدنية، والبراغي) خالية من أي عيوب، أو خدوش، أو تآكل.
  - التأكد من استخدام البراغي المزود بها جهاز السماعة الاختياري عند تركيب السماعة باستخدام هذا الجهاز.
- قم بتركيب الوحدة فقط في الأماكن التي من شأنها أن تتحمل حجم الوحدة من ناحية الهيكل، ويسهل تركيب الحامل. وإغفال ذلك قد يؤدي إلى سقوط الوحدة، وبالتالي يؤدي إلى إصابات بشرية، أو إلحاق الضرر بالمتكآت أو كلاهما.
- وبالنسبة لمقاس ووزن الوحدة، تأكد من قيام شخصين على الأقل بتركيب الوحدة. وقد يؤدي الإخفاق في ذلك إلى إصابات بشرية.
- لا تقم باستخدام وسائل أخرى غير الواردة بشأن تركيب الحامل. فعندما تعمل الوحدة بقوة كبيرة، قد تسقط ويتسبب ذلك في إصابات بشرية.

- ينبغي توصيل أسلاك السلامة بالوحدة، وإذا لم يتم ذلك، قد تسقط الوحدة وتؤدي إلى إصابات جسدية.
- استخدم الصواميل والبراغي المولوبة المخصصة لهياكل وتراكيب الأسقف والجدران. وقد يؤدي الإخفاق في ذلك إلى سقوط السماعه، الأمر الذي قد يتسبب في خسائر مادية أضرار بشرية.
- يجب ربط كل صامولة وبراغي جيدا وبصورة آمنة. تأكد من أن مفصلات الحامل مربوطة بإحكام والتأكد على ربطها مرة أخرى عقب التركيب لتفادي وقوع الحوادث التي قد تؤدي إلى إصابات بشرية.
- استخدم العناصر المناسبة أثناء عملية التجميع. ومخالفة قد يؤدي إلى سقوط الوحدة أو هذه العناصر، مما يؤدي إلى وقوع خسائر بشرية.
- لا تقم بتركيب الوحدة في أماكن عرضة للاهتزاز المتباين. قد يتسبب الاهتزاز العالي في تلف حامل التركيب، ومن المحتمل أن يؤدي ذلك إلى سقوط الوحدة، والتسبب في إصابات بشرية.
- لا تستخدم شحم التزليق المضاد للصدأ، فإذا وصل هذا الشحم إلى المادة الصمغية، أو الأجزاء المطاطية، فمن شأنه أن يؤدي إلى تلف هذه الأجزاء ويؤدي بالتالي إلى سقوط الوحدة، الأمر الذي قد يتسبب في وقوع أضرار بشرية.
- تجنب تركيب السماعه في أماكن قريبة من شاطئ البحر، أو من حمامات السباحة الموجودة بالأماكن المغلقة غير المعرضة للتهوية الجيدة. وتكون الحاملات في مثل تلك الأماكن عرضة للتآكل، مما قد يؤدي في نهاية الأمر إلى سقوط السماعه، الأمر الذي قد يتسبب في حوادث بشرية.

#### عندما تكون الوحدة قيد الاستخدام

- إذا وقع أي من الحوادث العارضة التالية أثناء الاستخدام، يجب الإسراع على الفور بغلاق الجهاز، وفصل القبس الموصل للتيار الكهربائي من مخرج التيار الكهربائي المتردد، والاتصال مباشرة بأقرب وكيل لشركة TOA. ولا تحاول تشغيل الوحدة مرة أخرى وهي على تلك الحالة، إذ قد يؤدي ذلك إلى نشوب الحرائق وحدوث الصدمات الكهربائية.
  - إذا أحسست برائحة الدخان، أو أية رائحة غريبة أخرى تتطلق من الوحدة.
  - إذا تسرب الماء إلى الوحدة، أو وصل أية مواد معدنية.
  - إذا سقطت الوحدة، أو انكسر صندوقها.
  - إذا تعرضت وصلات الدائرة الكهربائية لتقويم التيار من التلف (تعرض الأجزاء الداخلية منها للتلف، أو فصل التيار، وما إلى ذلك).
  - إذا تعرضت لعطل (لا تسمع نبرة الصوت).
  - إذا تعرضت لعطل (لا تظهر الصورة).
- ولنفاذي نشوب الحرائق، أو الصدمات الكهربائية، لا تقم بفتح أو تغيير مكان صندوق الوحدة، نظرا للجهد العالي المشحونة به عناصر هذه الوحدة. قم بإحالة عملية الصيانة إلى فني صيانة مختص.
- لا تضع الفناجين، أو الأطباق الكبيرة، أو أية حاويات أخرى للسوائل أو المواد المعدنية فوق الوحدة. وإذا سكبت أي من هذه العناصر عن طريق الخطأ داخل الوحدة، فقد يؤدي ذلك إلى نشوب الحرائق، أو الصدمات الكهربائية.
- لا تدخل أو تسقط أية مواد معدنية، أو قابلة للاشتعال في فتحات التهوية الموجودة على غطاء الوحدة، فقد يؤدي ذلك إلى نشوب الحرائق، أو الصدمات الكهربائية.
- لا تلمس القبس الموصل للتيار الكهربائي، أو الهوائي أثناء وجود ظاهرة برق أو رعد، فقد يؤدي ذلك إلى وقوع الصدمات الكهربائية.
- تثبت مخرجات التيار الكهربائي المتردد على مخرج التيار الكهربائي المتردد للوحدة. ولا يسمح بأن تتجاوز القوة الكهربائية بالواط تلك القيمة المحددة على الوحدة عند توصيل الجهاز. ومخالفة ذلك قد يؤدي إلى نشوب الحرائق أو تلف في الممتلكات.
- يجب التأكد من تركيب شاحن البطارية المخصص عند إعادة شحن البطارية. وقد يؤدي تركيب شاحن آخر إلى وجود تسريب في البطارية أو إلى انفجارها، الأمر الذي يؤدي إلى نشوب الحرائق، أو إصابات بشرية، أو إلحاق الضرر بالممتلكات، أو التلوث، أو أيا مما سبق.
- ولنفاذي التأثيرات السلبية للموجات الكهرومغناطيسية على المعدات الطبية، لابد من التأكد من غلق مفتاح التيار الكهربائي للوحدة عند وضعه بالقرب من المعدة الطبية.
- يجب التأكد عند استبدال الموصل الكهربائي من استخدام الموصل المرفق مع الجهاز. وقد يتسبب استخدام أي موصل آخر غير ذلك المرفق مع الجهاز في نشوب الحرائق أو الصدمات الكهربائية.

## عند تركيب الوحدة

- لا تدخل أو تنزع قيس توصيل التيار الكهربائي باستخدام الأيدي المبللة، إذ قد يؤدي ذلك إلى التعرض للصدمات الكهربائية.
- ولابد عند نزع موصل التيار الكهربائي من التأكد من الإمساك بقبس موصل التيار الكهربائي، وتجنب دائما شد السلك الموصل نفسه. قد يؤدي تشغيل الوحدة باستعمال موصل تيار كهربائي تالف إلى نشوب الحرائق أو الإصابة بالصدمات الكهربائية.
- تأكد عند تحريك الوحدة من فصل السلك الموصل للتيار الكهربائي من مخرج التيار المثبت على الحائط. قد يؤدي تحريك الوحدة في حالة توصيل السلك الموصل للتيار الكهربائي بمخرج التيار إلى تلف هذا السلك، الأمر الذي يؤدي إلى وقوع الحرائق أو الصدمات الكهربائية. تأكد دائما عند نزع السلك الموصل للتيار الكهربائي من الإمساك بالقبس بغرض نزعها.
- لا تقم بسد فتحات التهوية التي تغطي الوحدة. وقد يؤدي ذلك إلى ارتفاع درجة الحرارة داخل الجهاز مما قد يؤدي إلى اشتعال الحريق. ينبغي أيضا تنظيف فتحات التهوية من الغبار بصفة دورية.
- تجنب تركيب الوحدة في أماكن رطبة أو عرضة للأتربة، أو تركيبها في أماكن معرضة لضوء الشمس المباشر، أو بالقرب من السخانات، أو في أماكن تنتج من عوادم السيارات، أو الأبخرة، إذ قد يؤدي مخالفة ذلك إلى اشتعال الحرائق أو الصدمات الكهربائية.
- لابد من تتبع وضع الأقطاب بالمكان الصحيح (تبادل الأقطاب الموجبة والسالبة عند توصيل سلك التيار الكهربائي بموصلات الأقطاب من شأنه أن يؤدي إلى تلف مكبر الصوت أو السيارة).
- تركيب الوحدة فقط في أماكن ثابتة، واتخاذ التدابير اللازمة لمنعها من السقوط، أو التدرج على الأرض. وإذا سقطت الوحدة أو تحركت من مكانها، فمن الممكن أن يؤدي ذلك إلى وقوع إصابات بشرية أو تلف في الممتلكات أو أيًا منهما.
- يجب التأكد على أن يقوم بحمل الوحدة عند إخراج الوحدة أو تحريكها من مكانها شخصين على الأقل، فقد يؤدي تفريغ الوحدة أو إسقاطها إلى وقوع إصابات في الأفراد أو إلحاق الضرر بالممتلكات.
- تجنب وضع الوحدة عند مدخل أحد الأبواب، أو في مكان مرور الناس بصفة دائمة إذ قد يتعرض أحد الأفراد في الإداة أو الأسلاك، أو قد يتعرض للإصابة من جراء سقوط هذه الأشياء.
- تفويض أمر تركيب الأريال (الهوائي) إلى الوكيل الفني المختص لشركة TOA، وذلك لأن عملية التركيب تتطلب خبير فني. وقد يؤدي التركيب الخاطئ إلى سقوط الهوائي، الأمر الذي قد يؤدي إلى إحداث إصابات جسدية أو التعرض لصدمات كهربائية.
- تجنب ملامسة الحواف الحادة للوحدة لتفادي الإصابة بجروح.
- ولابد من التأكد من غلق مفتاح التيار الكهربائي للوحدة عند توصيل السماعة لنفاذي التعرض للصدمات الكهربائية.
- يرجى التأكد من إتباع التعليمات المذكورة أدناه عند التركيب داخل حامل. ومن المحتمل أن يؤدي الإخفاق في ذلك إلى نشوب الحرائق أو وقوع إصابات في الأفراد.
  - وضع الحامل على أرض ثابتة وصلبة، وتثبيتته عن طريق براغي خاصة بالتثبيت، أو اتخاذ تدابير أخرى لمنعها من السقوط.
  - عند توصيل السلك الموصل بالتيار الكهربائي للوحدة بمصدر التيار المتردد، لابد أن يكون ذو سعة تتمتع بها الوحدة.
  - يجب استخدام براغي الحامل المخصصة لحامل الوحدة.

## عندما تكون الوحدة قيد الاستخدام

- لا تضع أشياء ثقيلة على الوحدة إذ قد يؤدي ذلك إلى سقوطها وكسرها، الأمر الذي من المحتمل أن يتسبب في إصابات بشرية وخسائر في الممتلكات أو أي منهما، هذا بالإضافة إلى أن الحمل الثقيل ذاته من شأنه أن يسقط ويتسبب في الإصابات والضرر أو أي منهما.
- ينبغي التأكد من أن التحكم في الصوت في الوضع الأدنى قبل تشغيل مفتاح التوصيل بالتيار الكهربائي. من الممكن أن تتسبب الضوضاء العالية الناتجة عن الصوت العالي عند تشغيل الجهاز إلى إضعاف السمع.
- لا تقم بتشغيل الوحدة لفترات ممتدة بصوت يفوق الحد الطبيعي فقد يعرض تلك السماعات الموصلة للحرارة، الأمر الذي يتسبب في اشتعال الحرائق.
- يجب استخدام مكيف التيار المتردد للوحدة. ولابد من ملاحظة أن استخدام مكيف آخر قد يتسبب في اشتعال الحرائق.
- ينبغي فصل مقبس توصيل التيار الكهربائي من مصدر التيار المتردد عقب استكمال عملية الشحن فقد يؤدي خلاف ذلك إلى اشتعال الحرائق.
- إذا لم تستخدم الوحدة لمدة 10 أيام أو ما يزيد على ذلك، أو إذا استخدم التيار الكهربائي المتردد في تشغيل الوحدة، فيجب التأكد من فصل البطارية عن الوحدة لأن تسرب البطارية قد يتسبب في اشتعال الحرائق، أو الإصابات البشرية، أو تلوث البيئة.
- لابد من الاتصال بوكيل TOA لتنظيف الوحدة في حالة تراكم الأتربة بها لفترة طويلة، فقد يؤدي ذلك إلى اشتعال الحريق بالوحدة أو إلحاق الضرر بها.
- إذا تراكم التراب على مقبس التوصيل بالتيار الكهربائي أو بحائط مصدر التيار المتردد مما يؤدي إلى اشتعال الحريق فيجب تنظيفه بصفة دورية، وينبغي بالإضافة إلى ذلك وضع المقبس من مخرج الحائط بأمان.
- يجب غلق مفتاح التيار الكهربائي وفصل مقبس التوصيل الكهربائي من مصدر التيار المتردد لأغراض أمنية عند القيام بعملية التنظيف أو عند ترك الوحدة دون تشغيل لمدة 10 أيام أو ما يزيد، وأن مخالفة ذلك قد يتسبب في اشتعال الحرائق أو الصدمات الكهربائية.
- لابد من التأكد من مراعاة احتياطات كيفية الاستخدام التالية حتى لا تنتج أية حرائق أو إصابات بشرية عن تسرب البطارية أو انفجارها.
  - لا تجفف البطارية أو تقوم بفكها، أو بتسخينها، أو تضعها على النار.
  - تجنب استخدام البطاريات القديمة والجديدة، مع بعضها البعض.
  - لا تستخدم البطاريات ذات النوع غير القابل لإعادة الشحن.
  - لا تقم بعمل لحام قصدير على البطارية مباشرة.
  - التأكد من استخدام نوع محدد من البطاريات.
  - يراعى استخدام الأقطاب الصحيحة (ذات الاتجاه الموجب والسالب عند إدخال البطارية في الوحدة).
  - تجنب الأماكن المعرضة لضوء الشمس المباشر، أو درجة الحرارة، أو الرطوبة العالية عند تخزين البطارية.
- لا تقف أو تجلس على الجهاز، أو تتعلق بالوحدة، إذ قد يؤدي هذا الأمر إلى سقوطه أو إسقاطه، مما يؤدي ذلك إلى إصابات بشرية، وإلحاق الضرر بالممتلكات أو أيًا منهما.
- ينبغي القيام بفحص الوحدة بشكل دوري من قبل منفذ البيع الذي تم الشراء منه. وإن الإهمال في ذلك يتسبب في تآكل، أو تلف الوحدة، أو حامل التراكيب الخاص بها الأمر الذي يؤدي بدوره إلى سقوط هذه الوحدة، أو قد يؤدي إلى إصابات جسدية.
- تأكد من اتباعك للتعليمات التالية، إذ قد يؤدي الإخفاق في تنفيذها إلى أضرار سمعية.
  - خفض صوت السماعة لأدنى حد ممكن عند التشغيل.
  - لا تشغل السماعة بالقرب من أذنك.
  - وجه الوحدة في الاتجاه الذي لا يوجد به أي شخص عند إجراء اختبارات التشغيل.

## EMC PRECAUTIONS

**Warning:** Operation of this equipment in a residential environment could cause radio interference.

**Note:** This equipment has been tested and found to comply with the limits for a Class B digital device, pursuant to part 15 of the FCC Rules. These limits are designed to provide reasonable protection against harmful interference in a residential installation. This equipment generates, uses and can radiate radio frequency energy and, if not installed and used in accordance with the instructions, may cause harmful interference to radio communications. However, there is no guarantee that interference will not occur in a particular installation.

If this equipment does cause harmful interference to radio or television reception, which can be determined by turning the equipment off and on, the user is encouraged to try correct the interference by one or more of the following measures:

- Reorient or relocate the receiving antenna.
- Increase the separation between the equipment and receiver
- Connect the equipment into an outlet on a circuit different from that to which the receiver is connected.
- Consult the dealer to an experienced radio/TV technician for help.

### Traceability Information for Europe

Authorized representative:  
TOA Electronics Europe GmbH  
Suederstrasse 282, 20537 Hamburg,  
Germany  
URL: <https://www.toa.eu/>

### Traceability Information for Americas

Authorized representative:  
TOA Electronics, Inc.  
1 Harmon Plaza, Suite 700 Secaucus,  
New Jersey 07094, USA  
TEL: +1 650 452 1200  
URL: <https://www.toaelectronics.com/>