

SX210

Slimline Dual-driver Subwoofer

Features

- Slimline direct-radiator subwoofer
- 2 x 10" (250mm) drivers with 2" (50mm) voice coils
- Large ports for reduced air noise
- Perforated steel grille
- 4Ω nominal impedance
- M8 flying inserts

Applications

- Portable sound reinforcement
- Live music clubs
- Bars and restaurants
- Nightclubs
- Corporate AV events and conferences
- Weddings and parties
- Secondary stages at festivals
- HoW, leisure centres and retail outlets



The SX210 is a slimline dual-driver subwoofer designed for situations that call for a visually unobtrusive enclosure. It can be used singly, stacked or flown via integral M8 inserts and its ultra-compact size makes it ideal for applications where space is limited. It features dual 10" (250mm)/2" (50mm) voice coil drivers and generously sized low frequency ports for reduced air noise.

The SX210 enclosure is constructed from plywood and finished in black textured paint as standard, with white and RAL colour finish-es available to special order. An impact-resistant perforated steel grille protects the drivers, and the enclosure has twin ergonomic handles at the rear for easy handling. Rubber feet on the base resist movement and align with recesses in the top surface to assist stacking.

When used with full-range systems, crossover and EQ functions can be performed by an iK41 amplifier or by a DX4.0, DX0.4 or DX0.6 system controller combined with a VIA 2502, VIA 5002 or VIA 5004 amplifier.

SX210

Slimline Dual-driver Subwoofer

Technical Specifications

TYPE	Slimline, direct radiating subwoofer
FREQUENCY RESPONSE (1)	50Hz-150Hz \pm 3dB -10dB @ 42Hz
DRIVER	2 x 10" (250mm)/2" (50mm) voice coil, long excursion, ferrite magnet
RATED POWER (2)	400 W AES, 1600 W peak
RECOMMENDED AMPLIFIER	iK41, VIA2502, VIA5002, VIA5004
SENSITIVITY (10)	100dB
MAXIMUM SPL (9)	126 dB continuous, 132 dB peak, 138 dB peak with crest factor 4
NOMINAL IMPEDANCE	4 ohms
DISPERSION (-6dB)	Omnidirectional
CROSSOVER	80-120Hz active
ENCLOSURE	Birch/poplar ply
FINISH	Black textured paint
PROTECTIVE GRILLE	Black perforated steel
CONNECTORS	2 x NL4 type
PIN CONNECTIONS (INPUT)	1+/-
PIN CONNECTIONS (LINK)	1+/- to 1+/-
FITTINGS	16 x M8 inserts, 2 x bar handles
DIMENSIONS (INCL FEET)	(W) 718mm x (H) 295mm x (D) 465mm (W) 28.3ins x (H) 11.4ins x (D) 18.3ins
WEIGHT	20kg (44.1lbs)

Notes

- (1) Measured on-axis in half (2pi) space at 2 metres, then referred to 1 metre.
- (2) AES Standard ANSI S4.26-1984.
- (3) Measured in half (2pi) space at 2 metres with 1 watt input, using band limited pink noise, then referred to 1 metre.
- (4) Measured in half (2pi) space at 2 metres using band limited pink noise, then referred to 1 metre.
- (5) Measured on-axis in open (4pi) space at 2 metres, then referred to 1 metre.
- (6) Measured in open (4pi) space at 2 metres with 1 watt input, using band limited pink noise, then referred to 1 metre.
- (7) Measured in open (4pi) space at 2 metres using band limited pink noise, then referred to 1 metre.
- (8) Measured in open (4pi) space at 2 metres with 2.83v input, using band limited pink noise, then referred to 1 metre.
- (9) Calculated from half-space sensitivity and rated power.
- (10) Measured in half space (2pi) at 2 metres with 1 W input, using band-limited pink noise, then referred to 1 metre.

Trade Descriptions Act

Due to Martin Audio's policy of continuing improvement, we reserve the right to alter these specifications without prior notice. Martin Audio is committed to refining state of the art sound reinforcement, combining in-depth product and field applications research with advanced manufacturing techniques. Every Martin Audio product is built to the highest manufacturing standards and rigorously tested to ensure that it meets the performance criteria specified in the design.

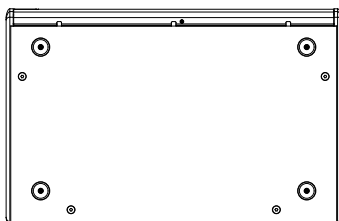
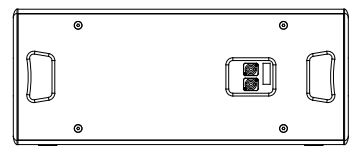
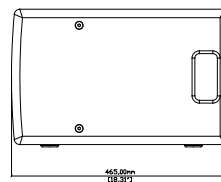
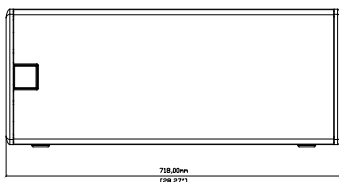
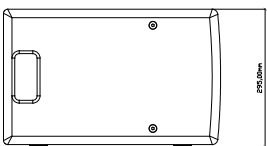
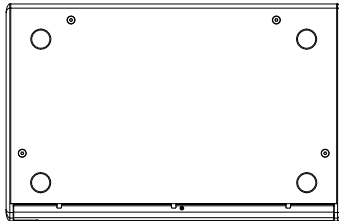
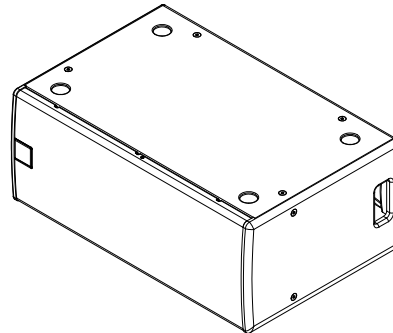

SX210

Martin Audio Ltd
Century Point, Halifax Road, High Wycombe
Buckinghamshire HP12 3SL, England

Telephone: +44 (0) 1494 535 312
Facsimile: +44 (0) 1494 438 669
Email: info@martin-audio.com

All information is Copyright © 2025 Martin Audio Ltd.



www.martin-audio.com