

O-LINE™

User Guide v3.2



Martin Audio O-Line User Guide



Contents

Martin Audio O-Line User Guide	1
Approvals.....	3
Unpacking the unit	3
Introduction.....	4
Tools	5
Warranty.....	6
O-Line module pack	7
4 x O-Line wall mounting kit Part Number ASF20021.....	8
8-16 x O-Line wall mounting kit Part Number ASF20022	9
O-Line flying kit Part Number ASF20023	10
System preparation	11
Splay angle adjustment	12
O-Line 4 module wall mounting.....	18
O-Line wall mounting 8-16 modules.....	22
O-Line flying system.....	34
O-Line Bottom Cover	40
System wiring	44
General	44
Amplifier choices and limiter settings	44
Clip Limiter settings	45
Controller presets?	45
O-Line array patches.....	47
Single channel configurations.....	47
Two channel configurations	52
Four channel configurations.....	56
Advanced Optimised System	58
iK81	58
Display 2	58
Vu-Net	63
Wiring Advanced Systems	68
4-Module Arrays.....	68
8-Module Arrays.....	68
12 Module Arrays	69
16 Module Arrays	71
Wiring Individual modules.....	73

Approvals



This equipment conforms to the requirements of the EMC Directive 89/336/EEC, amended by 92/31/EEC and 93/68/EEC and the requirements of the Low Voltage Directive 72/23/EEC, as amended by 93/68/EEC.

EMC Emission: EN55103-1:2009

EMC Immunity: EN55103-2:2009

Safety: IEC60065:2002 + A2:2010

Unpacking the unit

Thank you for purchasing a Martin Audio CDD Series speaker system. Every Martin Audio loudspeaker is built to the highest standard and thoroughly inspected before it leaves the factory. After unpacking the system, examine it carefully for any signs of transit damage and inform your dealer if any is found. It is suggested that you keep the original packaging so that the system can be repacked at a future date if necessary. Please note that neither Martin Audio nor its distributors can accept any responsibility for damage to any returned product which arises through the use of non-approved packaging.



Please think of our environment.

When the product has reached the end of its useful life, please dispose of it responsibly through a recycling centre.

Introduction

Thank you for purchasing your Martin Audio O-Line Micro Line array system.

O-Line delivers consistent audio coverage with unprecedented accuracy in a wide variety of architectural environments, using just one amplifier channel per array in many applications. By utilising a complement of unique, Martin Audio designed drivers, and mechanical alignment techniques, simple EQ and Limiting is the only processing required.

An O-Line module uses 2 x 89mm reflex-loaded, mid/low radiators either side of a central strip of 5 x 14mm HF devices in a unique, patent pending arrangement with a spacing of only 21mm between each element. The result is side lobe-free vertical dispersion from the high frequency section. The 'cones' of the two custom-designed LF drivers are sculpted from an ultra-light, stiff material and precisely follow the ideal contour of the HF horn walls (patent pending). This provides constant horizontal directivity from low mid, right up to extreme high frequencies.

Rather than applying DSP to a traditional column, O-Line's vertical beam-forming is achieved by physically articulating individual array modules to curve the array. The actual array configuration for a specific venue is determined by powerful optimisation software, which makes intelligent judgements about the 'goodness' of the array's SPL distribution against objective target functions.



O-Line arrays are constructed by simply connecting individual modules together in column lengths of 4 to 24 units as determined by the software.

O-Line modules are finished in a neutral light grey and combine to form aesthetically pleasing, variable length arrays, of outstanding audio quality that will enhance even the most demanding architectural environment.

O-Line is an ABS moulded product in light grey. As the colour is integral to the cabinet material as opposed to being painted there is not a direct equivalent matching paint colour. The steel mounting brackets are powder coated using Pantone 428C and the bottom cover accessory which is MDF is painted using RAL7035. These are the closest matches to the cabinet colour in paint finishes.

Notes:

A variety of mounting and suspension systems are available. Make sure you have ordered the required wall mounting or suspension kit to suit your chosen installation method.

-  Martin Audio O-Line loudspeakers must be installed by experienced loudspeaker installation personnel using the full installation kit provided
-  It is the installer's responsibility to ensure that all relevant local, national and international electrical, fire and building safety regulations are complied with
-  Every O-Line loudspeaker must be fitted with a steel safety wire this can be fitted between an attachment bracket (provided) and a suitable supporting structure.

Tools

You will need the following tools for O-Line preparation and installation.

Tool	Size	Operation
Building arrays		
Screwdriver	PZ1	Rear covers removal/assembly
Allen Key/Socket Set	4	Link Plates assembly
Open Ended Spanner	10mm	Link Plates assembly
Screwdriver	S3	Wiring
4 Module Bracket		
Allen Key/Socket Set	5	Adding brackets to the array
Allen Key/Socket Set	8	Adding collar
Allen Key/Socket Set	6	Clamping collar
Open Ended Spanner	13mm	Clamping collar
8 - 16 Bracket		
Allen Key/Socket Set	5	Adding brackets to the array
Allen Key/Socket Set	8	Adding collar
Allen Key/Socket Set	6	Clamping collar
Open Ended Spanner	13mm	Clamping collar
Pliers		Split pin removal/fitting
Open Ended Spanner	8mm	Attaching Dog Grip
Flying Bracket		
Allen Key/Socket Set	5	Adding brackets to the array
Allen Key/Socket Set	6	Adding brackets to the array
PZ = Pozidrive		S = Straight/Flat head

Warranty

Martin Audio O-Line products are warranted against manufacturing defects in materials or craftsmanship over a period of 5 years from the date of original purchase.

During the warranty period Martin Audio will, at its discretion, either repair or replace products which prove to be defective provided that the product is returned in its original packaging, shipping prepaid, to an authorised Martin Audio service agent or distributor.

Martin Audio Ltd. cannot be held responsible for defects caused by unauthorised modifications, improper use, negligence, exposure to inclement weather conditions, act of God or accident, or any use of this product that is not in accordance with the instructions provided by Martin Audio. Martin Audio is not liable for consequential damages.

This warranty is exclusive and no other warranty is expressed or implied. This warranty does not affect your statutory rights.

O-Line module pack

Each pack of O-Line modules comprises the following parts:

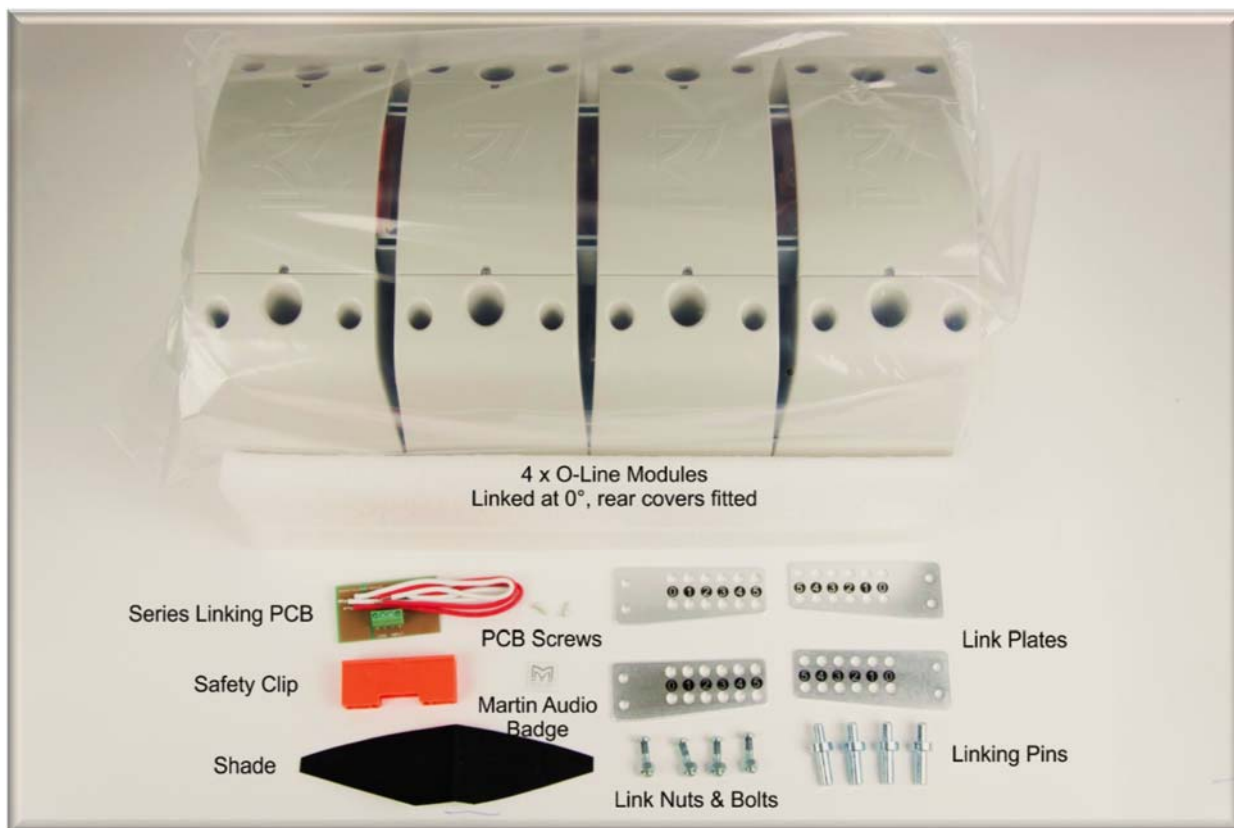

O-Line module pack

The self-adhesive shade included in the module pack may be used to prevent down-lighting from shining down through the grilles in architecturally sensitive locations.

There are three methods of installing an O-Line Loudspeaker system. Choose the position and number of O-Line modules required as indicated by Display 2 software.

The Link plates, link nuts and bolts, Linking Pins and safety clip are to enable linking blocks of four modules.

The series Linking PCB and PCB screws enable easy wiring in series between two blocks where linking in parallel would reduce the impedance to a value lower than is suitable for your amplifier.

A self-adhesive Martin Audio badge is supplied to be attached to a complete array, usually placed on the bottom module.

4 x O-Line wall mounting kit Part Number ASF20021

Each 4 x O-Line wall mounting kit comprises the following parts:

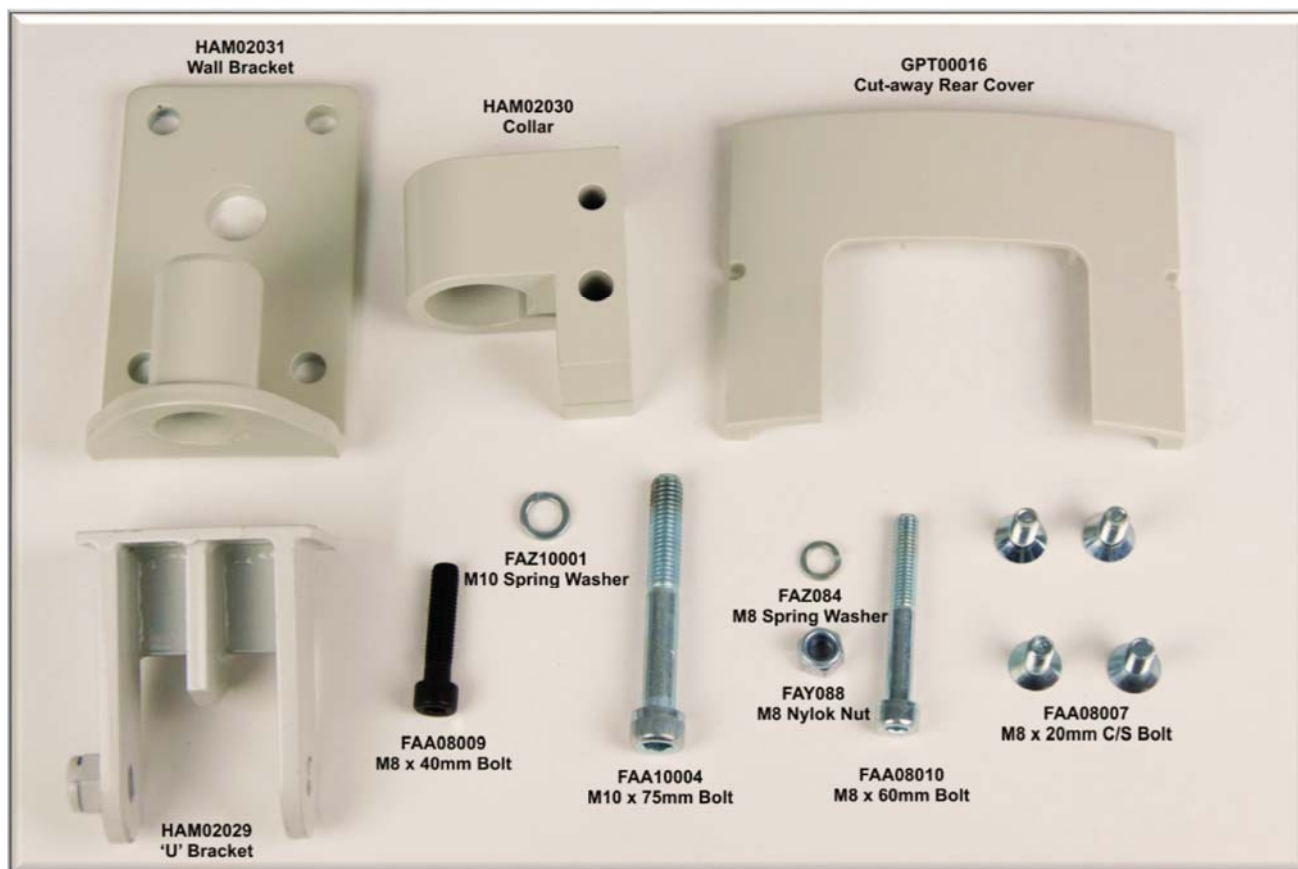

ASF20021 4 x O-Line wall mounting kit

The 4-module wall mount kit comprises a wall bracket which can be fixed in place in a first fix. A U-Bracket and collar are attached to the bottom of the array. A cut-away cover fits around the mounting bracket in place of the bottom rear cover on the array. The array is fitted to the wall bracket and vertical adjustment is made with an M8 bolt.

8-16 x O-Line wall mounting kit Part Number ASF20022

Each 8-16 x O-Line wall mounting kit comprises the following parts:

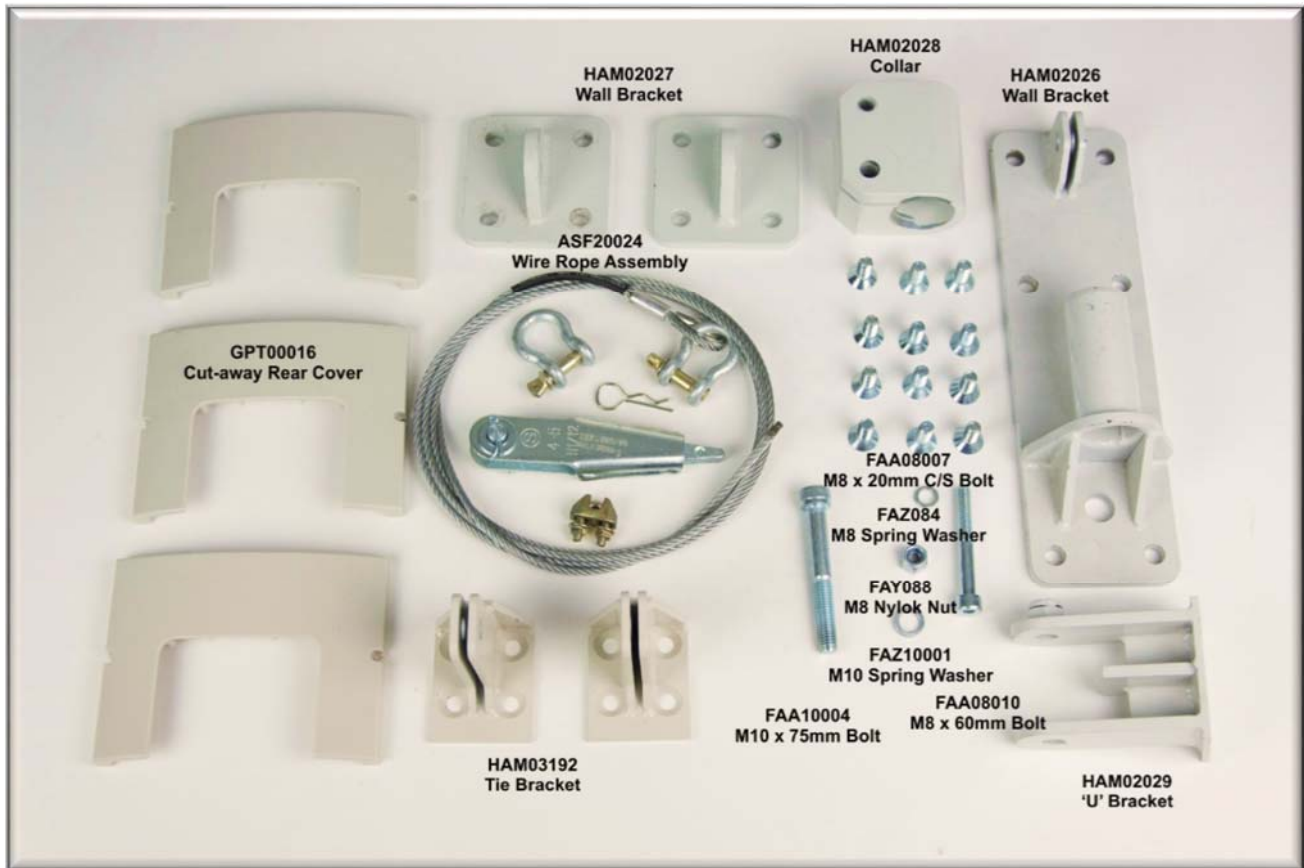

ASF20022 8-16 x O-Line wall mounting kit

The 8 to 18 module wall bracket has a large wall bracket and a similar U bracket and collar attached to the bottom of the array. A tie bracket is attached to towards the top of the array and is joined to a small wall bracket to secure the array at the desired angle. Adjustment is made with a wire rope wedge assembly and permanently secured with a wire rope "dog". A second tie bracket and small wall bracket is supplied to provide a secondary safety attachment. Three cut away rear covers are provided to go around the collar bracket and two tie brackets.

O-Line flying kit Part Number ASF20023

Each O-Line flying kit comprises the following extra parts.

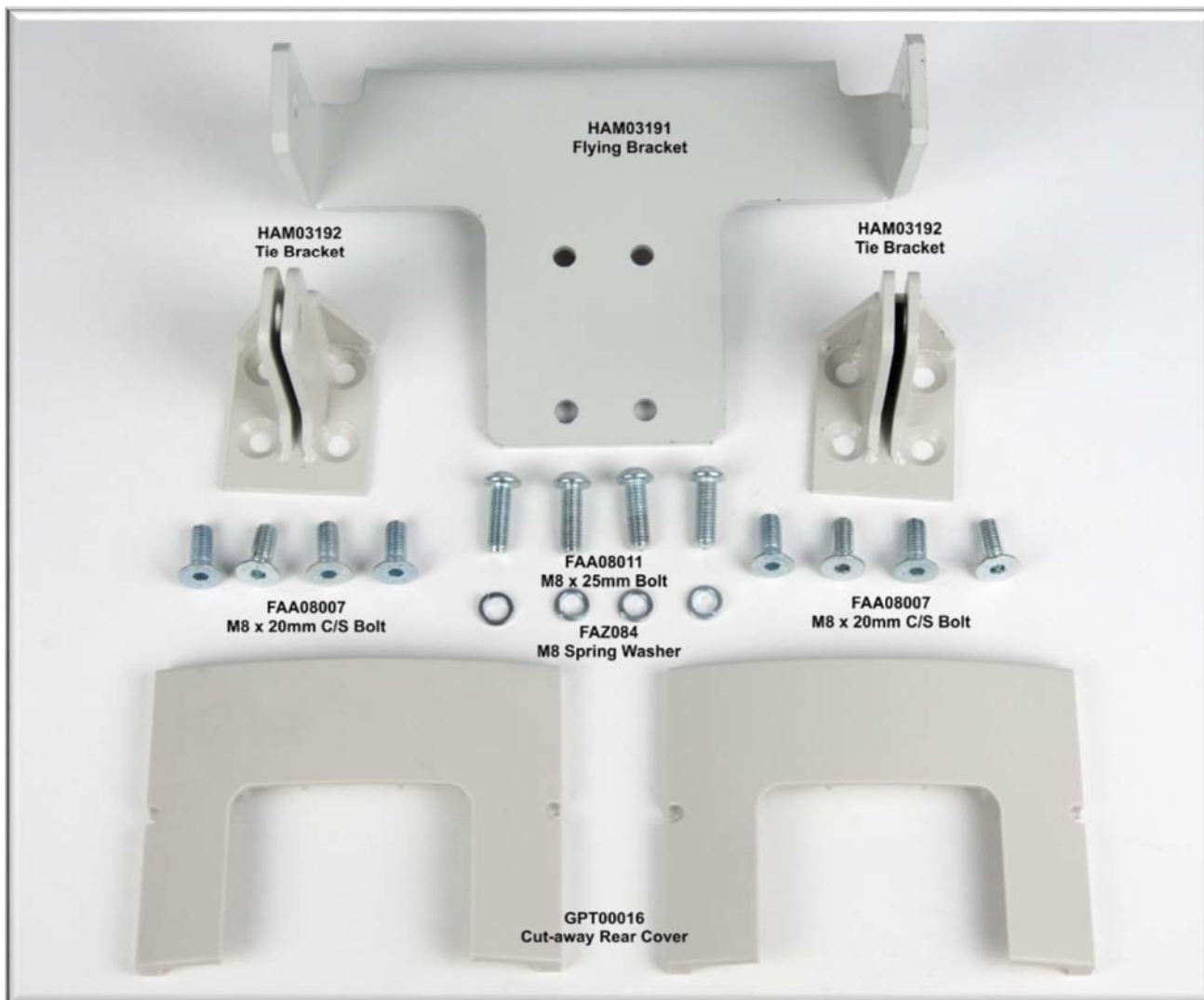

ASF20023 O-Line Flying kit

The flying kit comprises a flying bracket which attaches to the top of the array providing two points from which to suspend the array using steel rope or chain. Two tie brackets are supplied, one which is attached towards the bottom of the array and is used with a third suspension point to page the array back to the required angle, and a second provided as a secondary safety fixing. Two cut-away rear covers are supplied to go around the tie brackets.

System preparation



To avoid flattening or damaging your O-Line grilles, we strongly recommend that you keep each block of four O-Line modules in their high density foam trays.



Take off the rear covers by removing the rear screws from each unit.

Tips!

- 1) If you are not using a magnetic screwdriver, we recommend covering the rear port holes with some tape as shown above to prevent dropping screws down the ports.

- 2) Press the screws into the front of the high density foam tray to avoid losing them.

Splay angle adjustment

O-Line modules are shipped with splay angles set at 0 degrees. Having determined splay angles and mounting or suspension attachment points using the Display 2 software, set the required inter-module splay angles as follows:

Tip!

Leave modules that require wall mounting or suspension attachments until last, as you need to orient and fit these brackets before you insert the link pins.

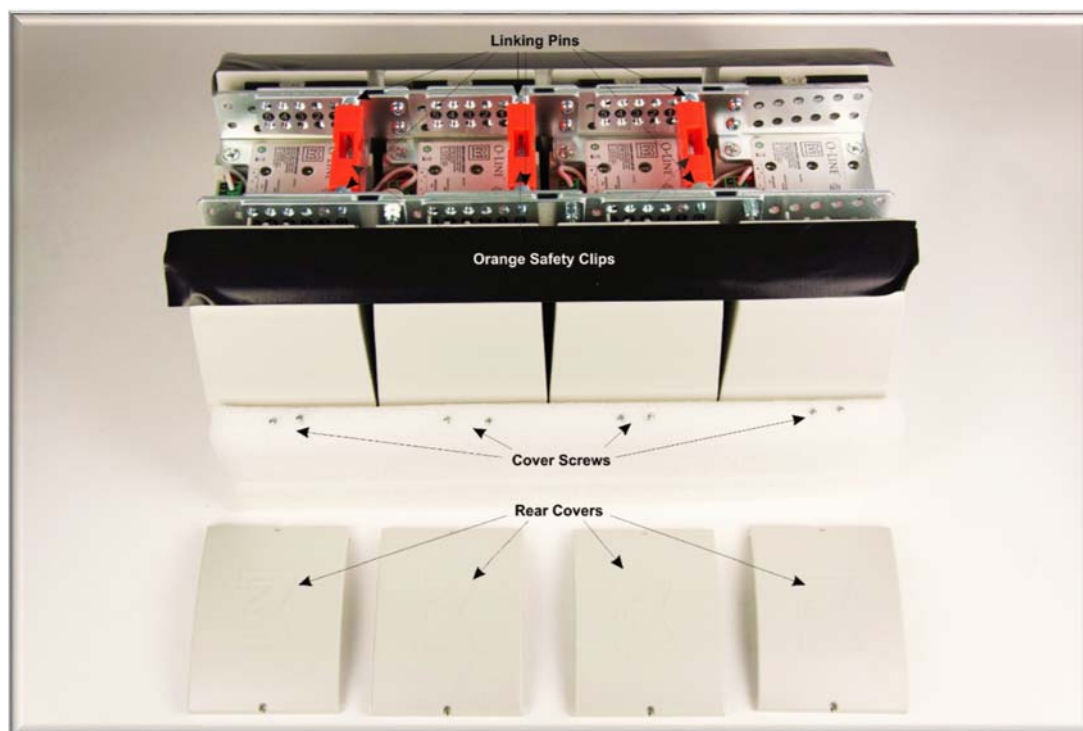

- 1) Remove the rear cover
- 2) Remove the orange safety clip



Remove the orange safety clip

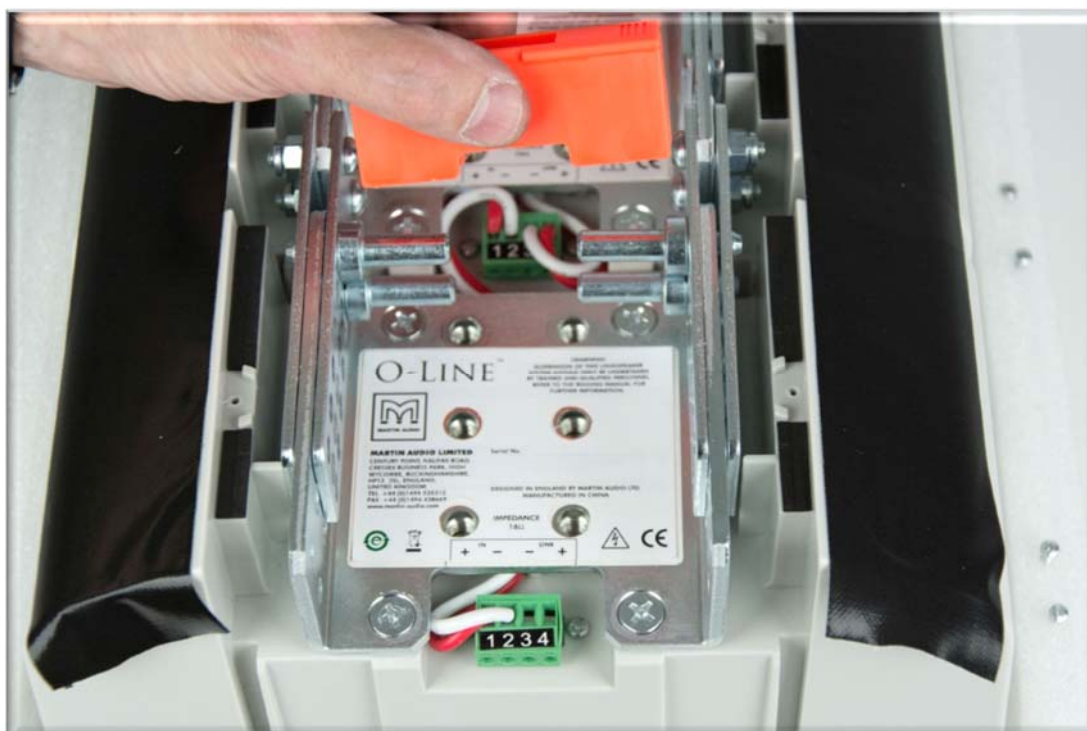

- 3) Remove the linking pins from the splay angle holes.



Remove the link pins

Tip!

If the linking pins are difficult to remove, loosen the four link plate nuts and bolts for that module. Don't forget to re-tighten them after you have positioned the link pins.

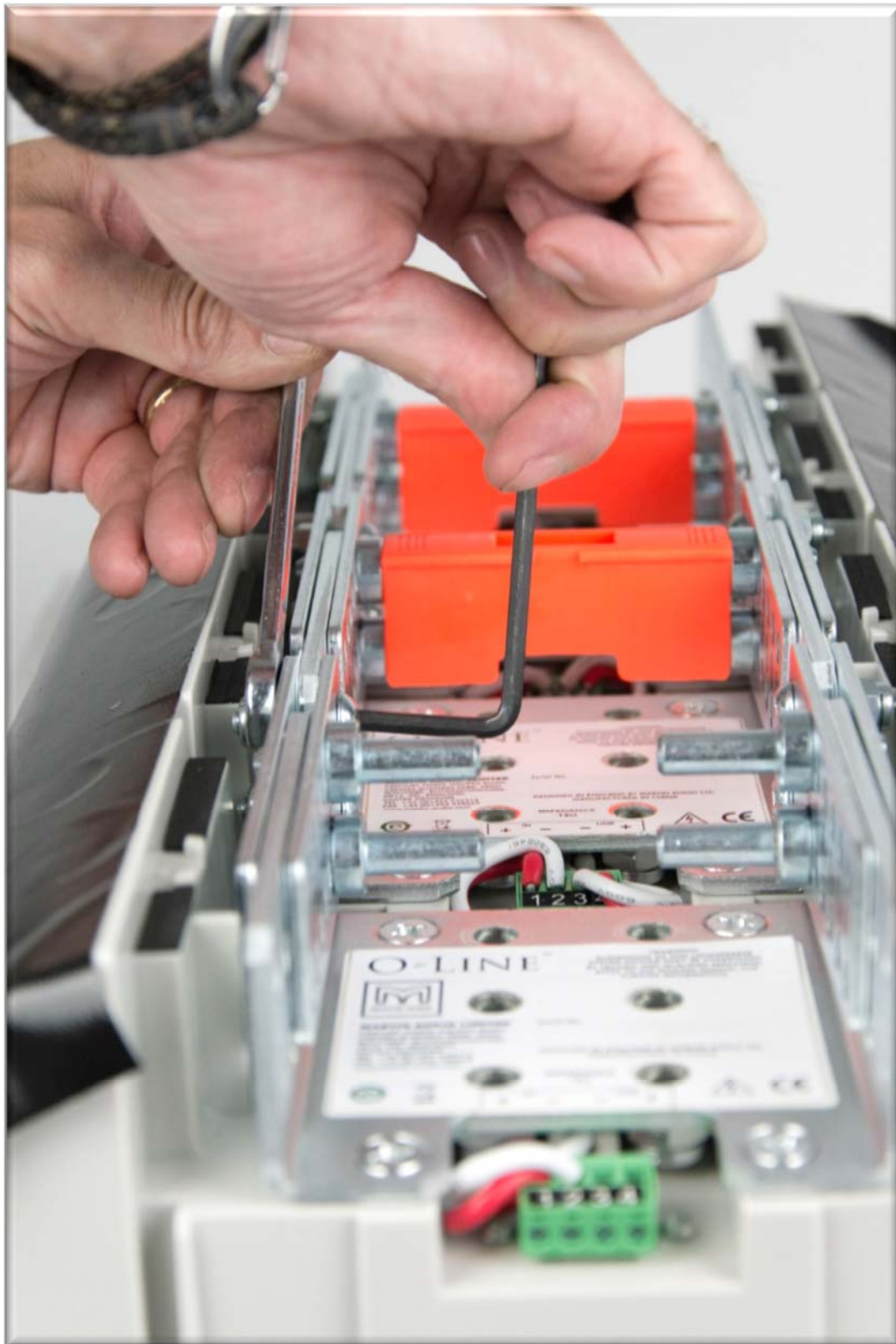

Loosen the link plate nuts and bolts if necessary

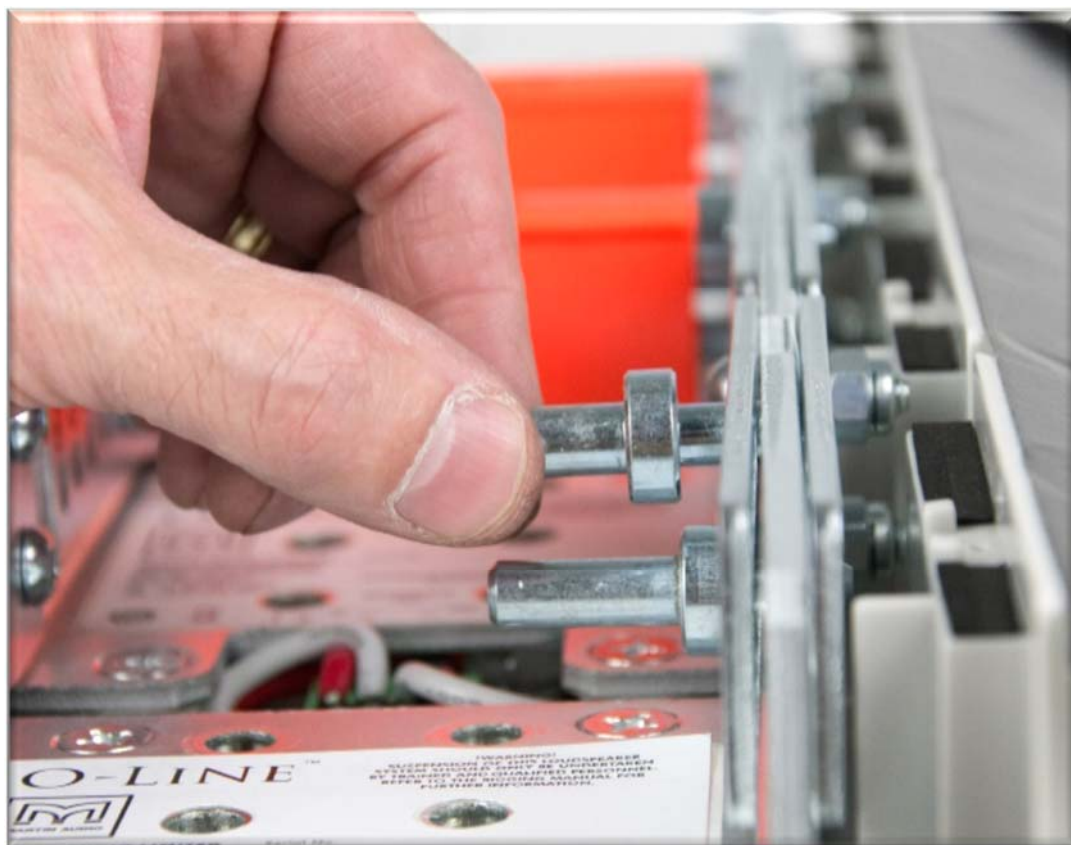

- 4) Angle the O-Line modules to the required splay angle lining up the link plate holes at the required angle positions marked on the bracket.



Link plates holes lined up for 1 degree splay

- 5) Insert the four linking pins into the aligned link plate holes.



Replace link pins, in this example for a 5 degree splay

- 6) Replace the orange safety clip after positioning all four linking pins.



Replace the orange safety clips!

O-Line 4 module wall mounting

To remind you:

- ✚ Martin Audio O-Line loudspeakers must be installed by experienced loudspeaker installation personnel using the full installation kit provided.
- ✚ It is the installer's responsibility to ensure that all relevant local, national and international electrical, fire and building safety regulations are complied with.
- ✚ Every O-Line loudspeaker must be fitted with a steel safety wire this can be fitted between an attachment bracket (provided) and a suitable supporting structure.

Use Display 2 to calculate the required angle for the bottom module. If the angle is 3 to 5 degrees, fit the U-bracket using the top four holes of the six holes of the bottom module. If the angle is 0 to 2 degrees, fit the U-bracket using the bottom four holes of the bottom module. Then fit the linking pins for the required angle.

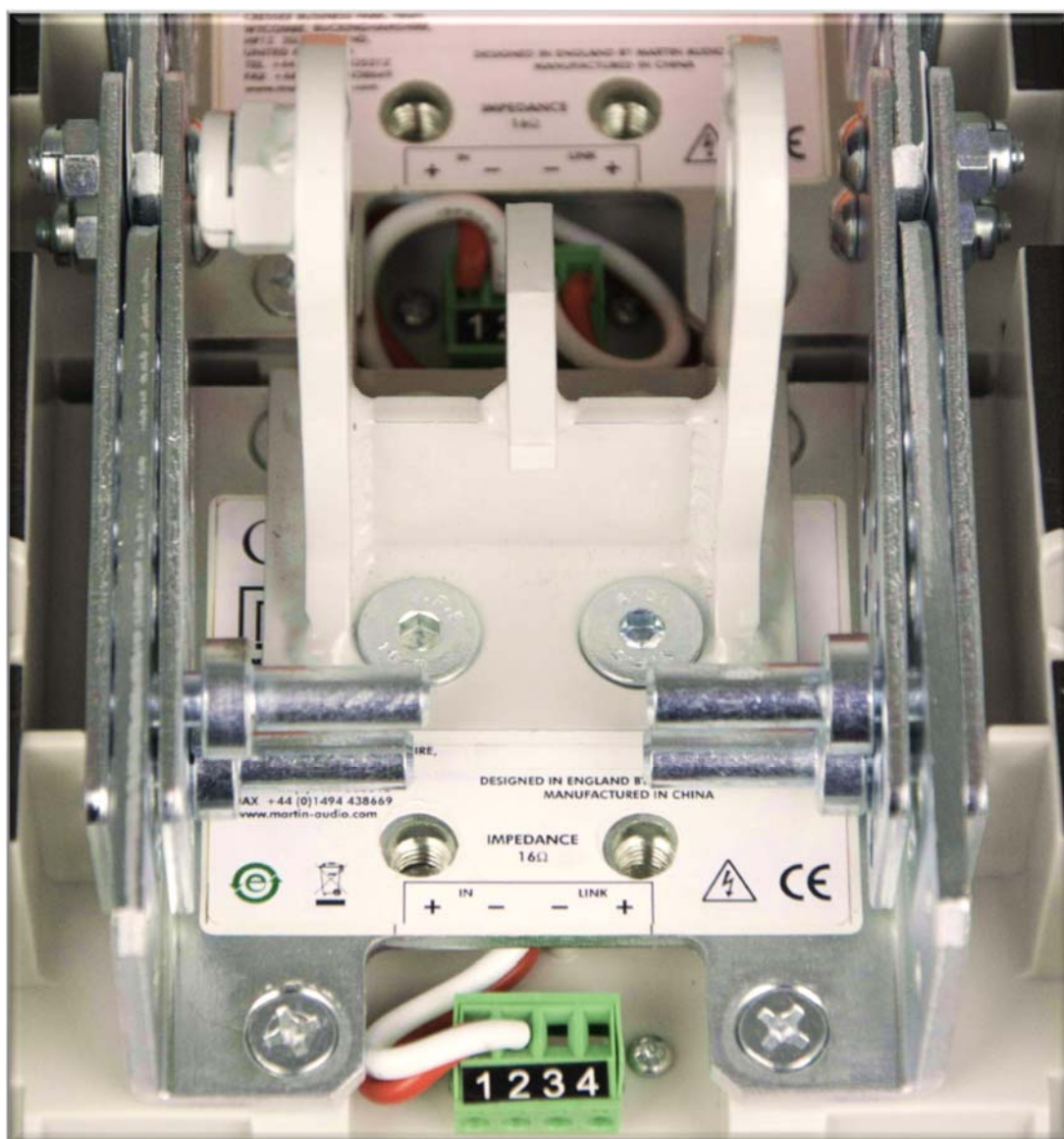

U-bracket (shown positioned for 4 degree linking pin position)

If you haven't already, set the O-Line module splay angles as calculated by Display 2.

Fit the collar to the U-bracket using the FAA10004 M10 x 75 bolt. Note the orientation – collar towards the top of the array (left on the photograph).

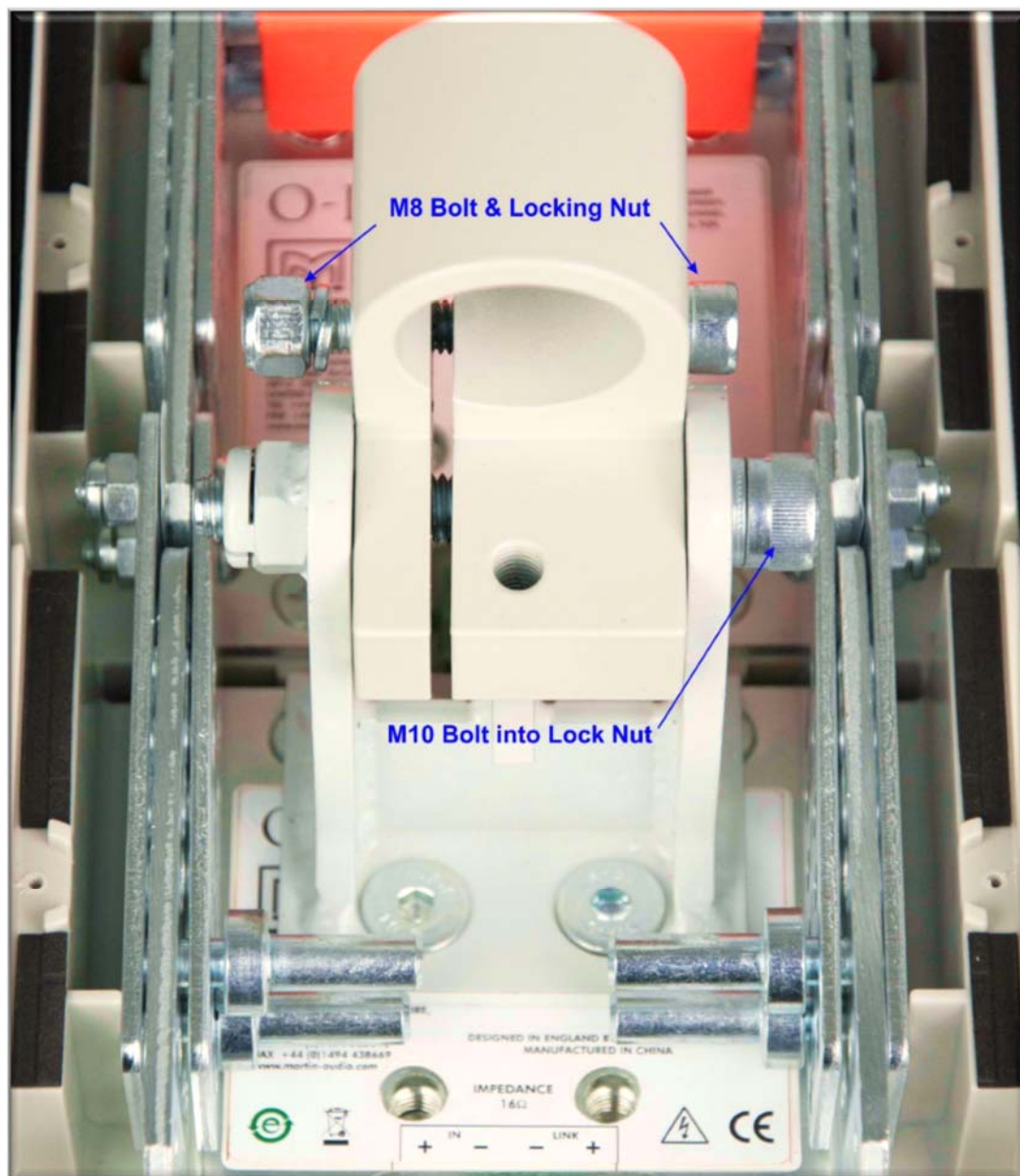

Tighten the M10 bolt – tight enough so that it protrudes at least 1.5 thread turns through the lock nut but still allows U-bracket movement for easy adjustment.

Fit the FAA08005 M8 x 60mm bolt (see the kit pictures earlier) loosely to the collar as shown above.

Wire up the array. See the section **System wiring** for further details.

Fit rear the rear covers - using the cut out version for the module with the bracket.



Fit the HAM02012 wall bracket – see kit identification picture earlier.

Lift the block of four O-Line modules onto the wall mounting – see below.

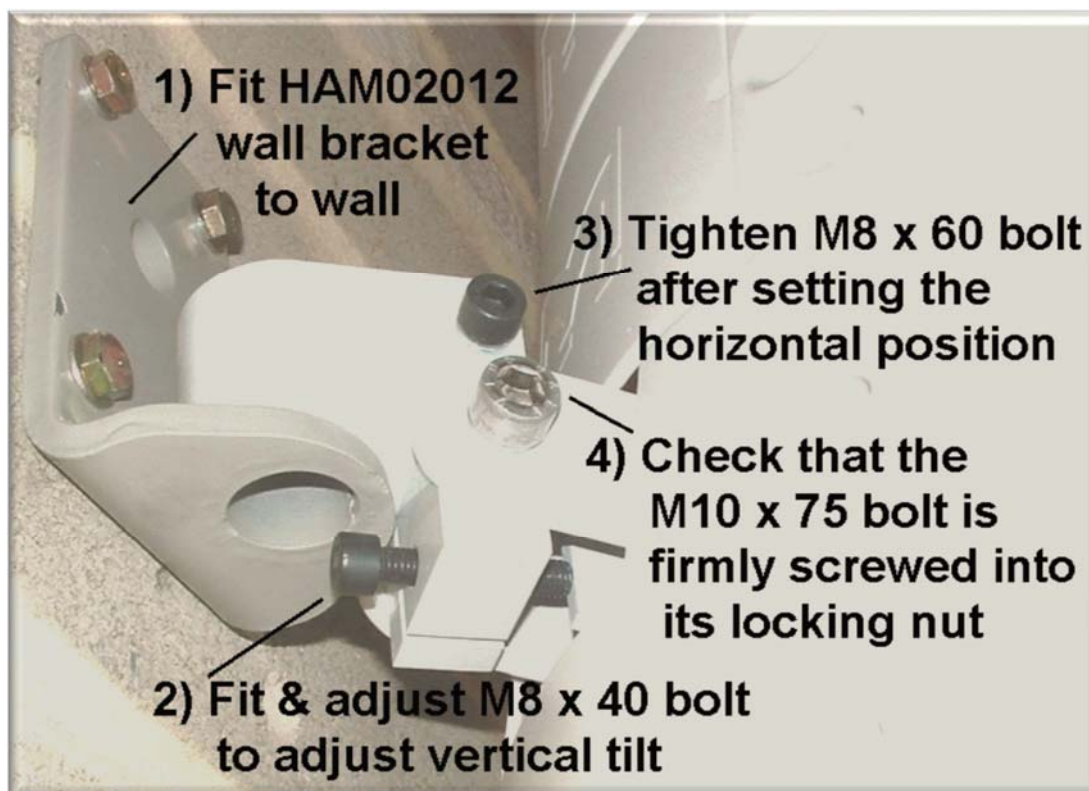

Fit the FAA08004 M8 x 40 bolt and adjust screw to set vertical tilt angle.

Tighten clamping bolt (FAA08005 M8 x 60) after setting the horizontal angle.

Check that the M10 x 75 collar-to-U-bracket bolt is firmly screwed into its locking nut.

Recheck everything!

ALWAYS double check that all orange safety clips are in place as this is essential to ensure that the array will stay safely locked together.

O-Line wall mounting 8-16 modules

To remind you:

- ✚ Martin Audio O-Line loudspeakers must be installed by experienced loudspeaker installation personnel using the full installation kit provided.
- ✚ It is the installer's responsibility to ensure that all relevant local, national and international electrical, fire and building safety regulations are complied with.
- ✚ Every O-Line loudspeaker must be fitted with a steel safety wire this can be fitted between an attachment bracket (provided) and a suitable supporting structure.

Prepare your blocks of four O-Line modules to the splay angles recommended by the Display 2 software

Add link plates to the lower module of the upper 4-module blocks using the link plate bolts and lock nuts supplied with each four O-Line modules – see kit picture at the beginning of this document.



Fit link plates (supplied with each four modules) to the bottom of each block of four.

Fit 4-module blocks together by interlocking modules together near the front.

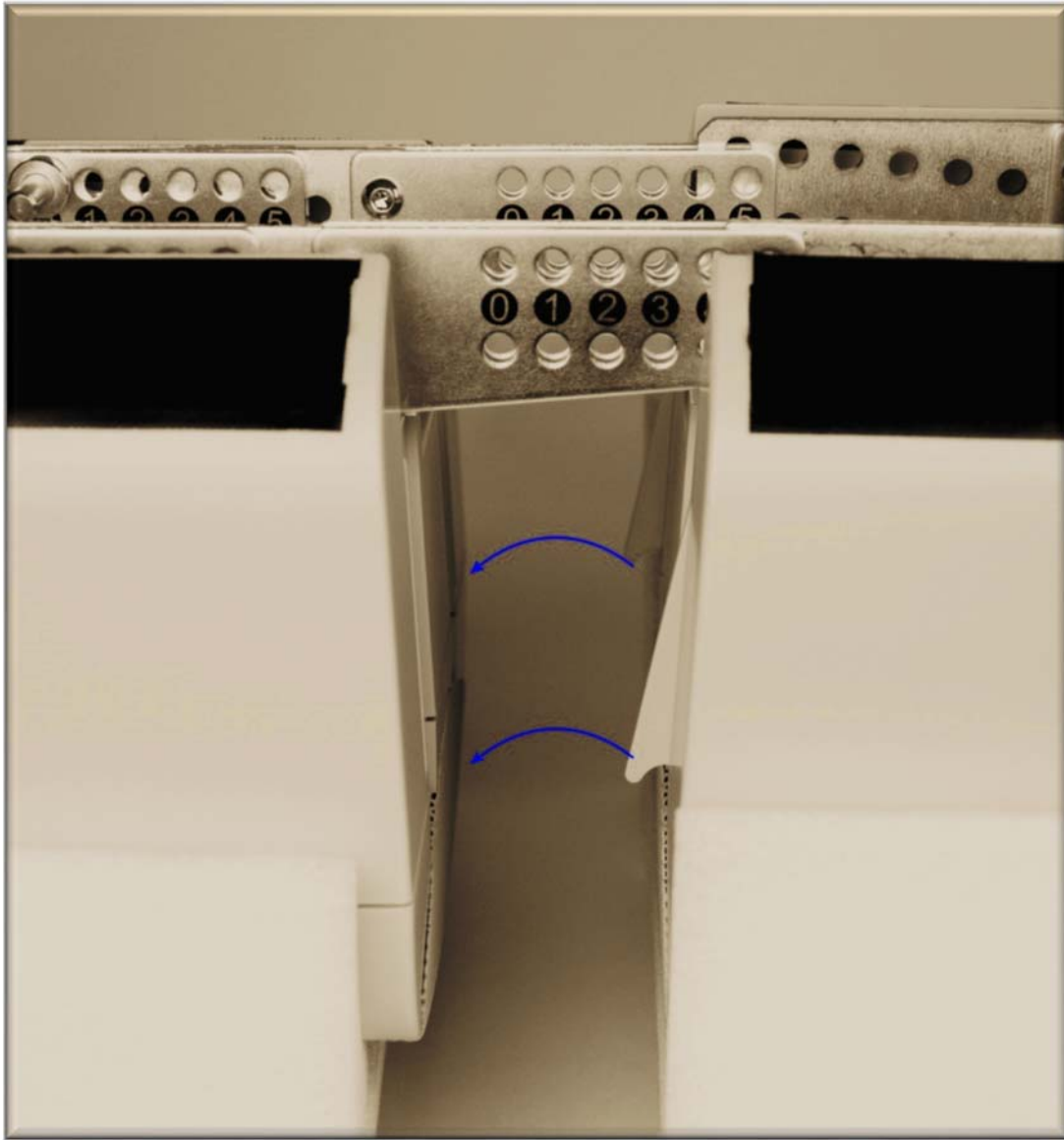

Interlock modules together

Ensure that the tongues (right) on the top of the lower block of modules are properly locked into the slots (left) on the upper block– see arrows in above illustration.



Adding the linking pins

Add the linking pins as shown in section.

Remember to add the safety clips!



Wire the 4-module blocks together into bigger blocks of 8 or 12 modules using the connector PCB supplied with each block of four O-Line modules if a series connection is required. See the section on system wiring for further details.

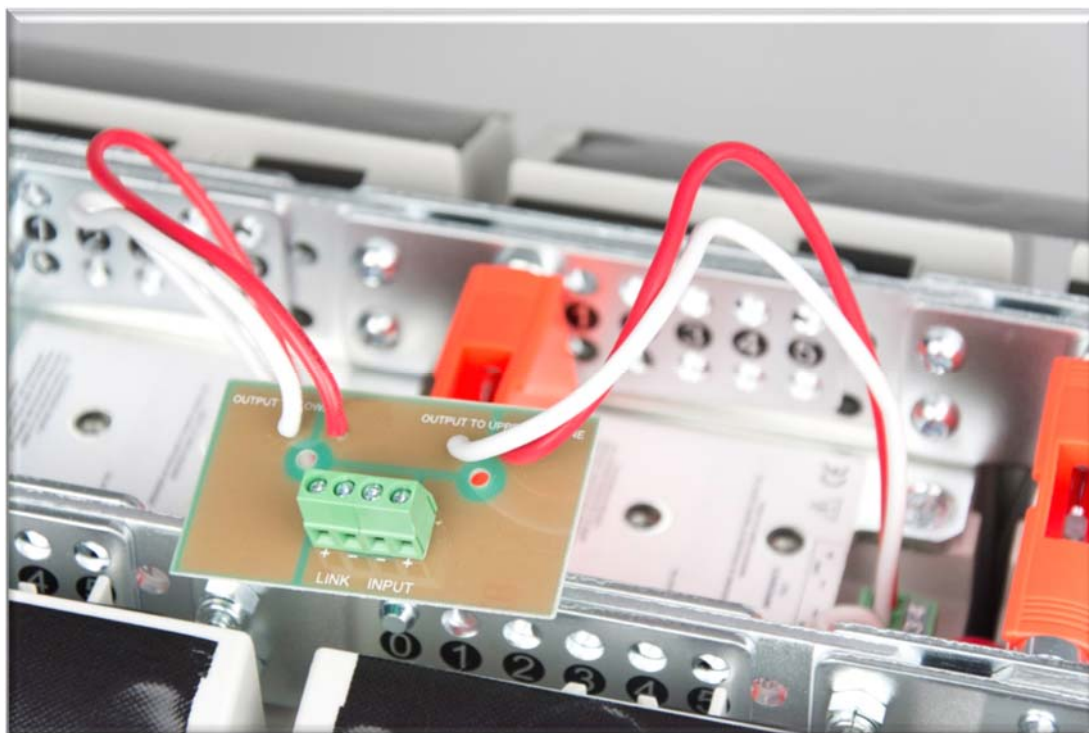

Notes:

- ⚡ White = negative and red = positive
- ⚡ Upper and lower block connections are marked on the PCB.
- ⚡ Route the wires between the linking pins to avoid crushing them when the rear covers are replaced.

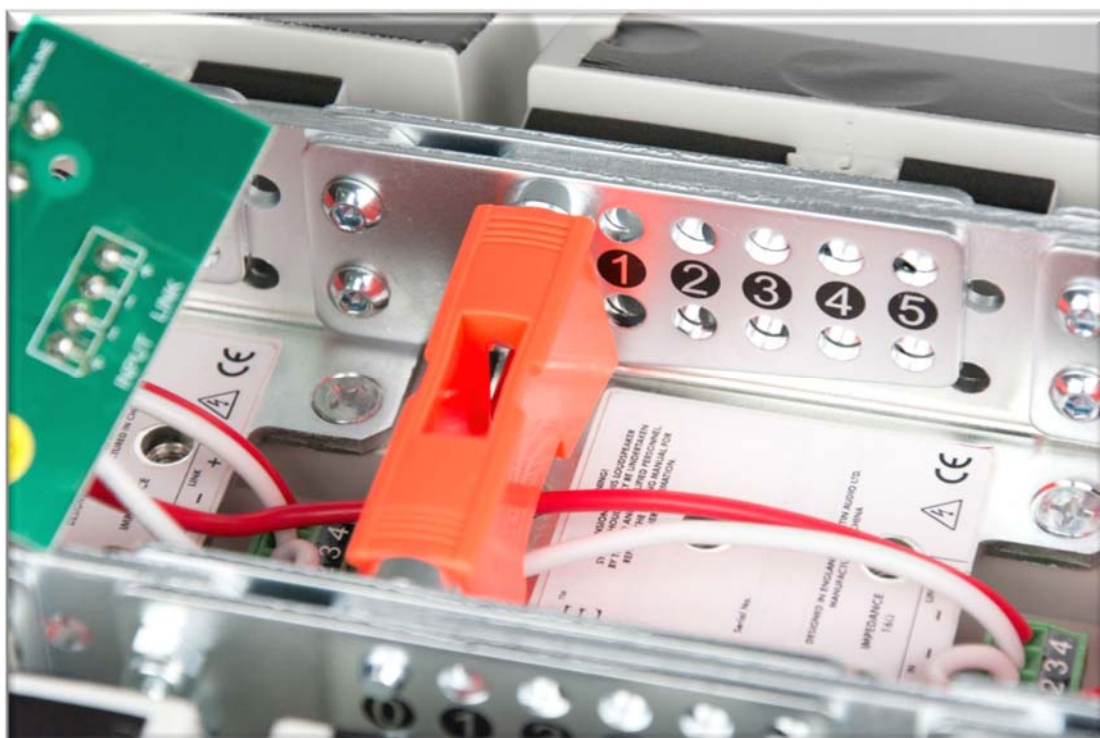

Screw the pcb to the inside of the most convenient rear cover using the self-tapping screws provided with each set of four modules. Its orientation will depend on that module's linking pin positions.



Fit the U-bracket to the lower O-Line module first – and then the linking pins.

Final U-bracket positioning will be determined by the required linking pin positions – one position for 0-2 degrees and the other position for 3-5 degrees. See picture below.

Once you have fitted the U-bracket, angle the lower module to the required setting, ensuring the holes line up, then replace all four linking pins and the safety clip.

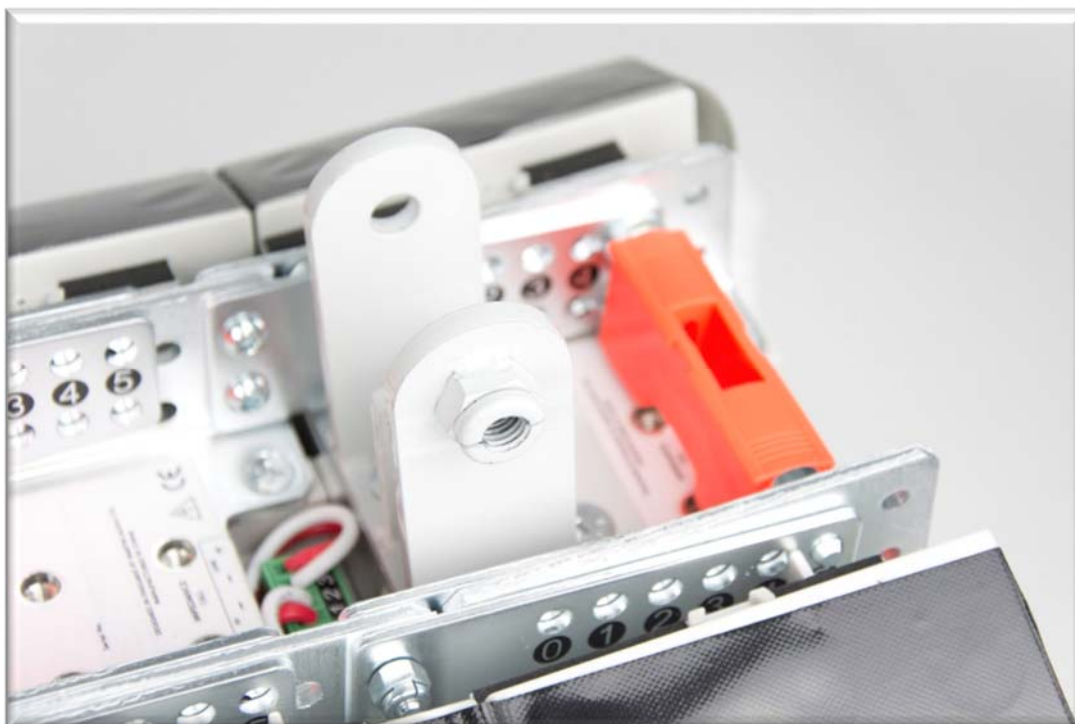

U-bracket positioned for 5 degree lower module angle

Fit a main HAM03192 tie-bracket to the O-Line module indicated by the Display 2 software.

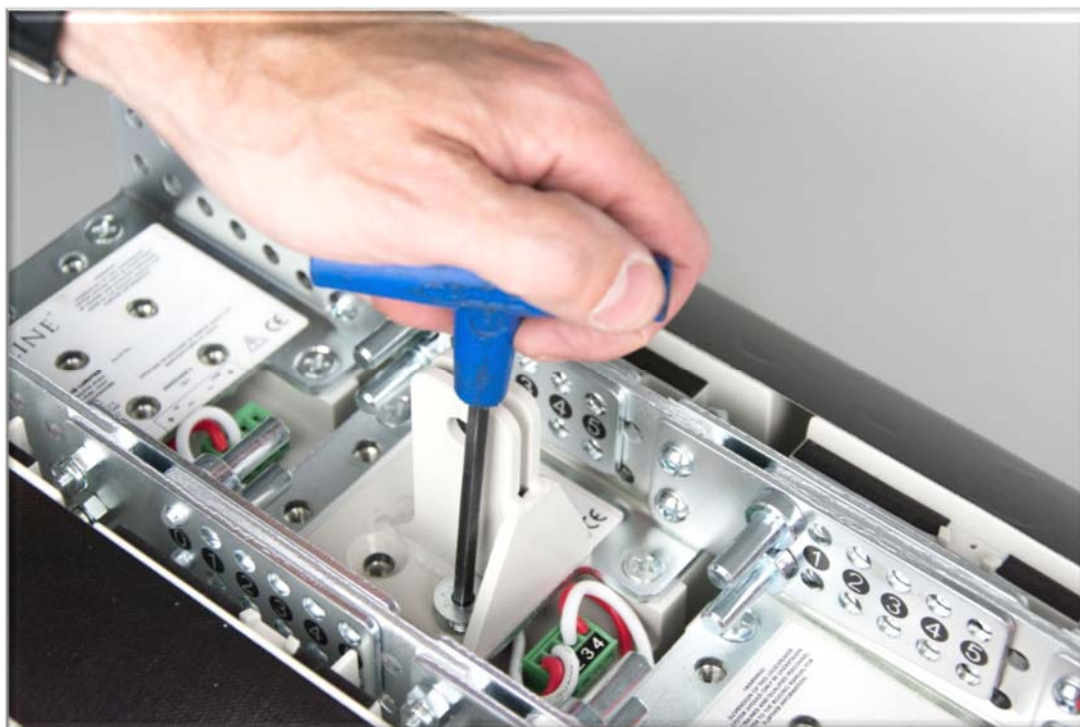

Again, the bracket position and orientation will be determined by the angle setting required for that O-Line module.

Remove the linking pins if necessary and fit the bracket in the correct orientation. Angle the O-Line module and replace the linking pins at the required angle.

Fit the second HAM03192 tie-bracket, to the top O-Line module.

Refit the rear covers using the cut-away covers supplied with the wall bracket kit around the tie bracket and U bracket.

Fit the collar to the U-bracket using the M10 x 65 cap head machine screw, in the orientation shown below.



Tip!

Leave the U-bracket screw (right above) and clamping screw (left above) finger tight until the system is mounted onto the wall bracket – remembering to tighten them fully at that stage.

After removing the pin and R-clip from the DIN15315 wedge fastener, load the ASF20024 wire rope as follows:



Place a loose loop of ASF20024 wire rope into the wedge socket.



Loop the wire round the wedge and pull it semi-tight.

Attach the wire rope assembly to the **main** tie bracket using the pin and R-clip. Note the R-clip washer.



Roughly adjust the length of the wire using the wedge socket.

Fit the top HAM02027 and bottom HAM02026 wall brackets onto the wall.



HAM02027



HAM02026

The Display 2 software will indicate the recommended heights of these brackets. Lift the array and lower the collar onto the spigot on the bottom bracket.



Tighten the clamp screw (arrowed).

Shackle the end of the wire rope to the top wall bracket.

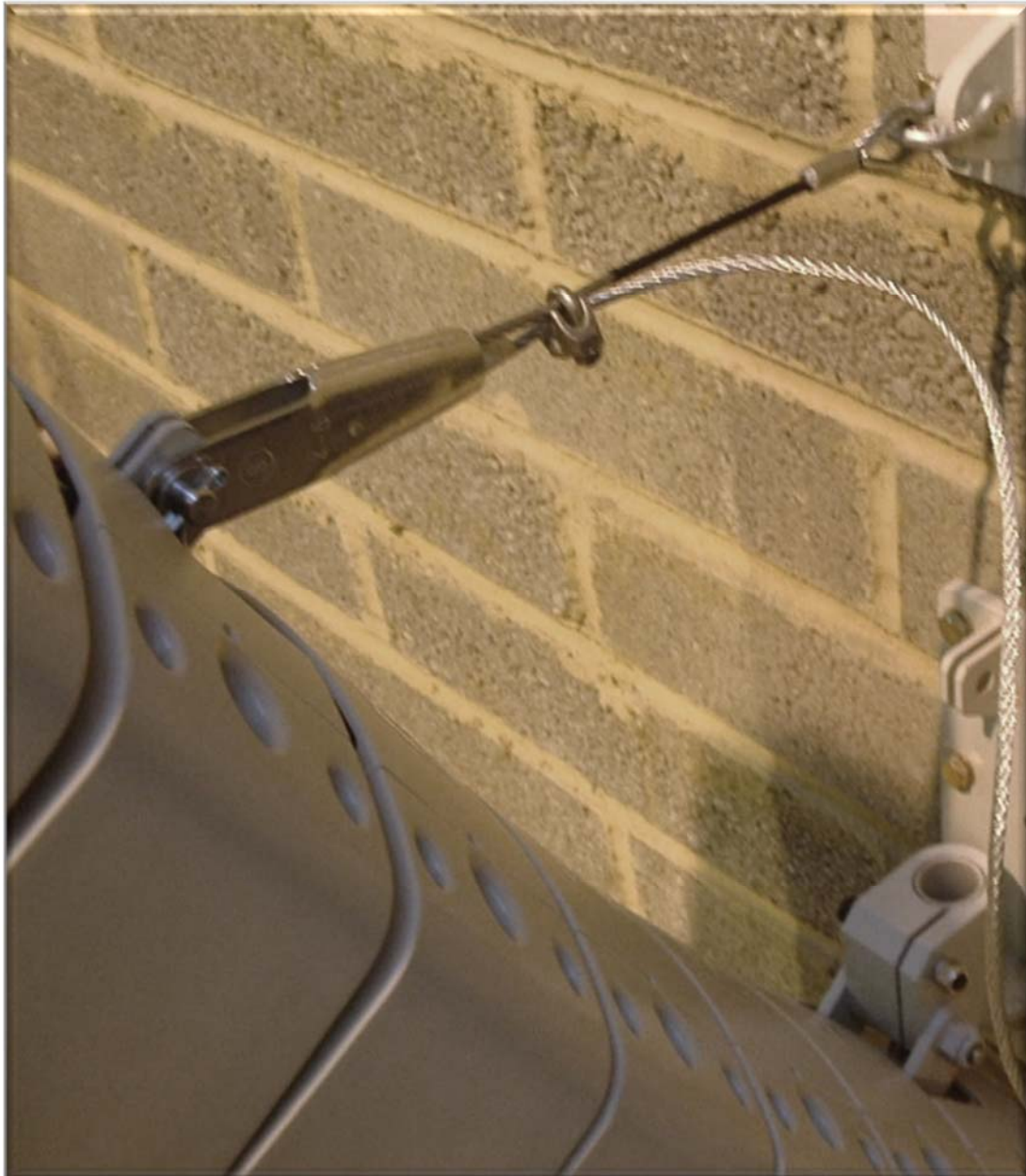

Use the wedge socket to fine tune the down tilt of the array. Once the angle is set, add the DIN1142 rope grips for extra security and make sure everything is tight.

Trim the wire rope if required.

Tighten the U-bracket-to-sleeve screw (arrowed).

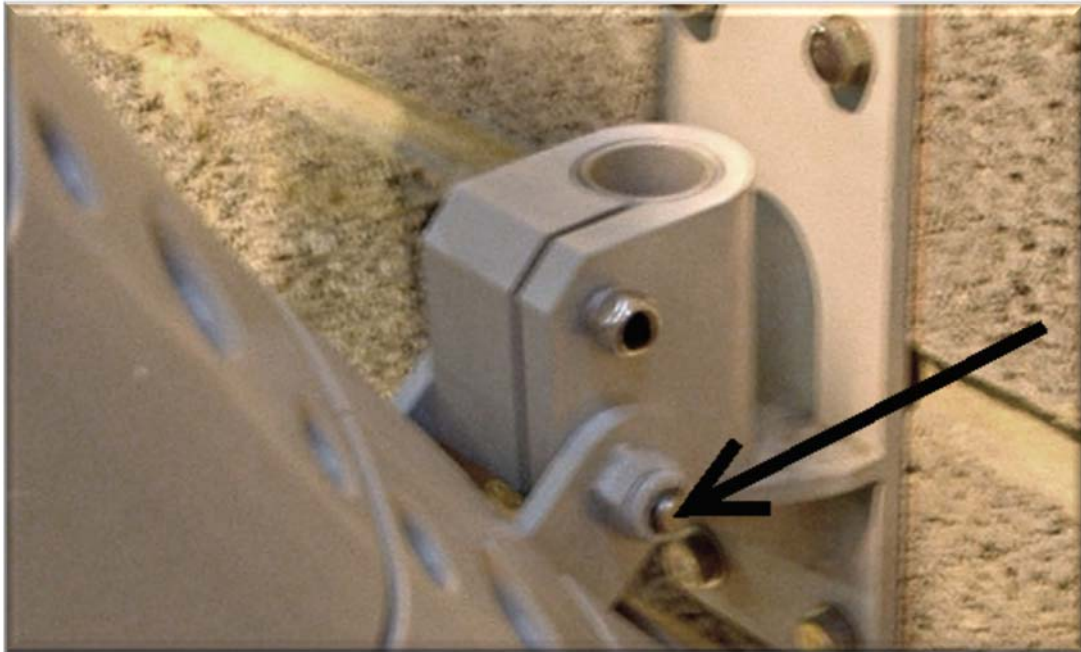

Add a safety wire rope between the second (top) tie-rocket and an approved, secure part of the building structure.

Recheck everything!

ALWAYS double check that all orange safety clips are in place as this is essential to ensure that the array will stay safely locked together.

O-Line flying system

To remind you:

- ✚ Martin Audio O-Line loudspeakers must be installed by experienced loudspeaker installation personnel using the full installation kit provided.
- ✚ It is the installer's responsibility to ensure that all relevant local, national and international electrical, fire and building safety regulations are complied with.
- ✚ Every O-Line loudspeaker must be fitted with an additional steel safety wire this can be fitted between the HAM03192 tie bracket and an approved supporting structure.

Prepare your 4-module blocks to the splay angles recommended by the Display 2 software.

If your flown array is larger than 4 modules, add link plates to the lower module of the upper 4-module blocks using the link plate bolts and lock nuts supplied with each four O-Line modules – see kit picture at the beginning of this document.



Fit link plates (supplied with each four modules) to the bottom of each block of four

Fit 4-module blocks together by interlocking modules together near the front.

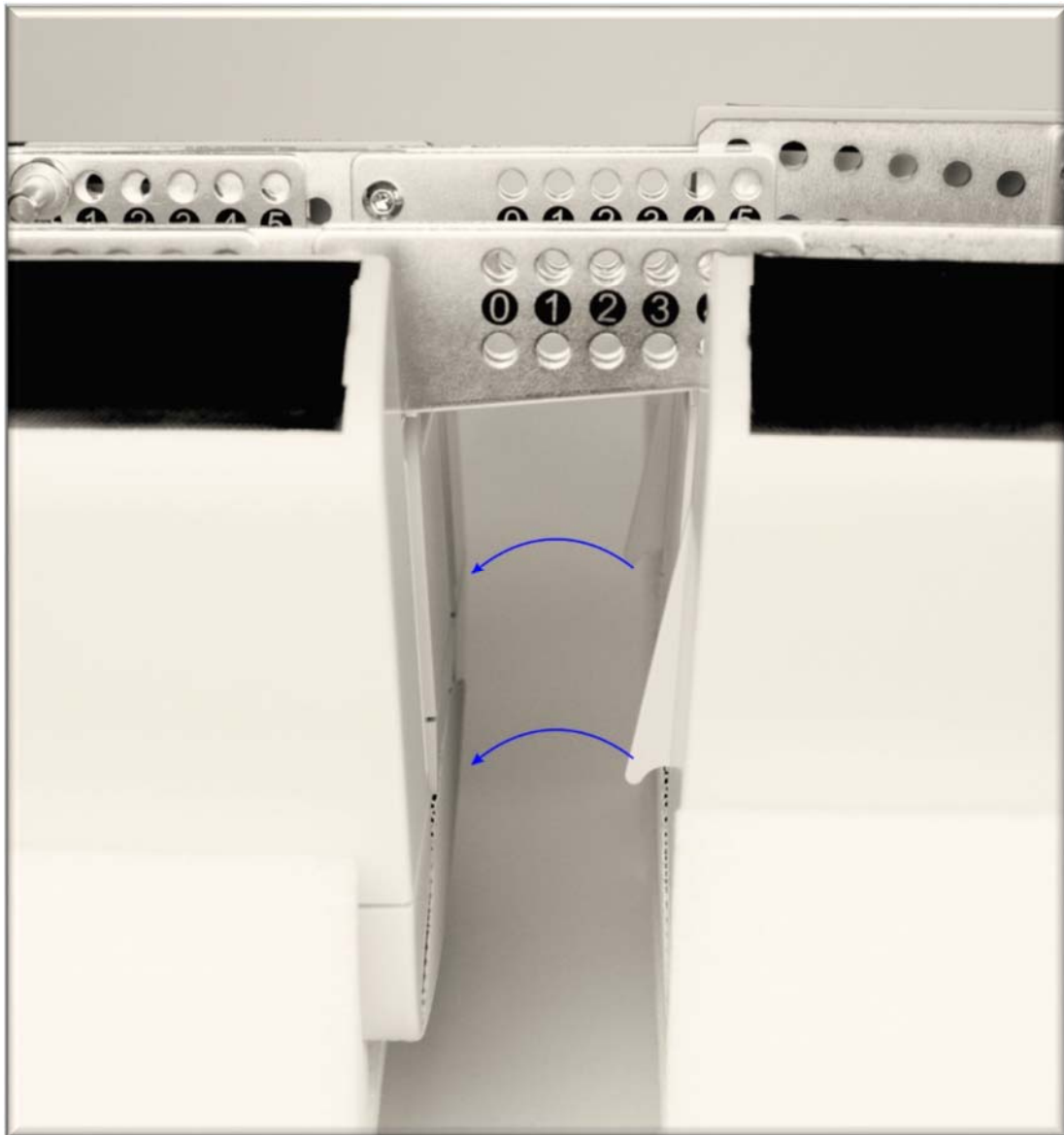

Interlock modules together

Ensure that the tongues (right) on the top of the lower block of modules are properly locked into the slots (left) on the upper block– see arrows in above illustration.



Adding the linking pins

Add the linking pins as shown in section 5.2 earlier.

Remember to add the safety clips!



Wire the 4-module blocks together into bigger blocks of 8 or 12 modules* using the connector pcb supplied with each block of four O-Line modules if a series connection is required. See the section on system wiring for further details.

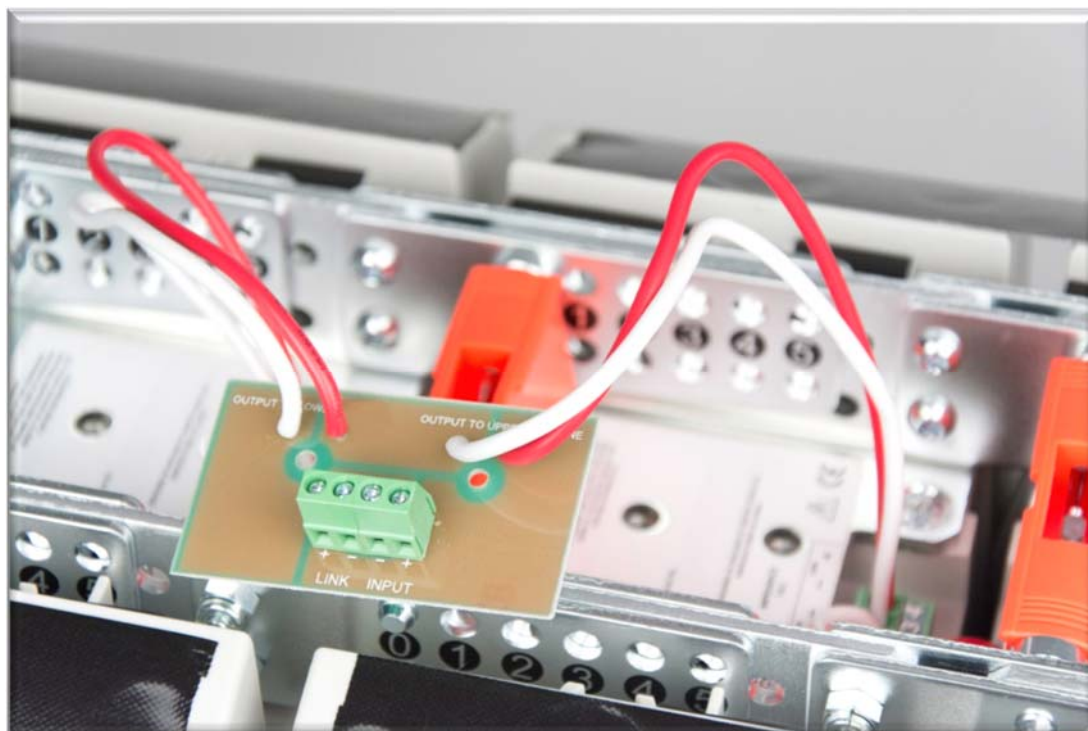

Notes:

- ⚡ White = negative and red = positive.
- ⚡ Upper and lower block connections are marked on the PCB.
- ⚡ Route the wires between the linking pins to avoid crushing them when the rear covers are replaced.

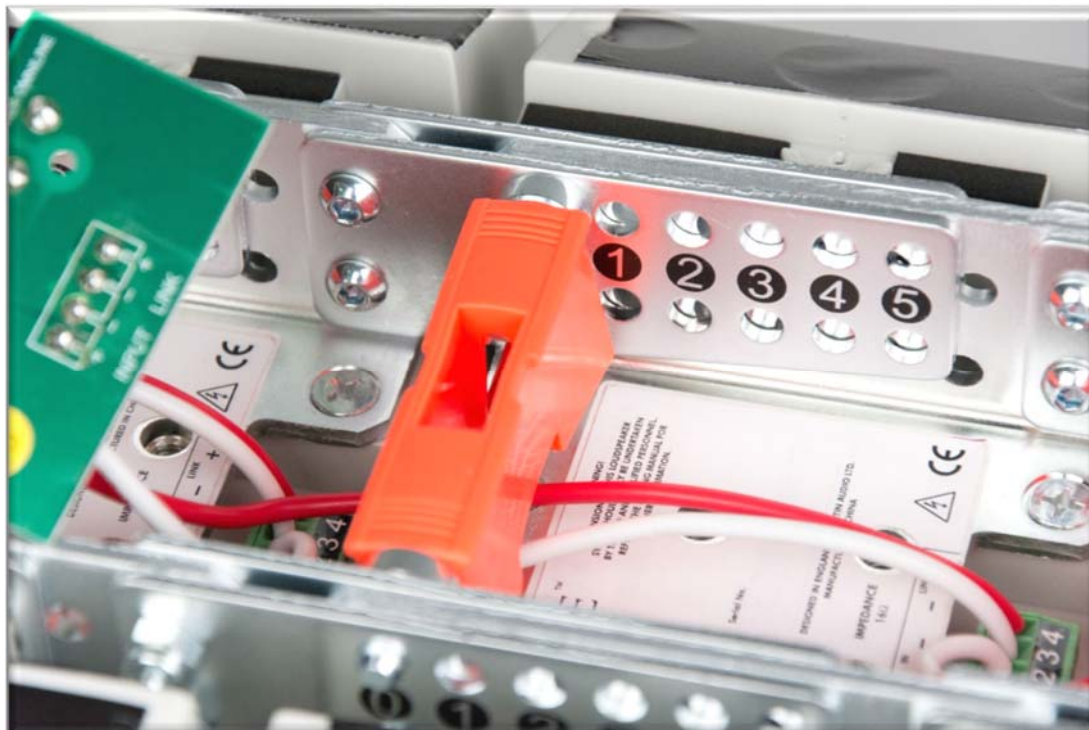

Screw the PCB to the inside of the most convenient rear cover using the self-tapping screws provided with each set of four modules. Its orientation will depend on that module's linking pin positions.



Fit the HAM03191 flying bracket (arrowed) to the top O-Line module of the array.



HAM03191 flying bracket in place

Fit one of the HAM03192 tie brackets to the second module from the top of the array to form a safety point.

The position and orientation of the bracket will be determined by the angle setting of the O-Line module to which it is fitted. Attach the bracket – temporarily removing the linking pins if necessary.



HAM03192 tie bracket in place

Fit the second HAM03192 tie-bracket to the O-Line module indicated by the Display 2 software.

Again, the bracket position and orientation will be determined by the angle setting required for that O-Line module.

Remove the linking pins if necessary and fit the bracket in the correct orientation. Angle the O-Line module and replace the linking pins at the required angle.

Refit the rear covers using the cut-away covers around the tie brackets.

Employ a professional rigger to rig the system from the HAM03191 flying bracket at the front and the lower HAM03192 tie brackets at the rear.

Add an extra safety wire rope between the top tie-bracket and an approved, secure part of the building structure.

Recheck everything!

If you are inexperienced, or in any doubt at all, get an independent safety check.

ALWAYS double check that all orange safety clips are in place as this is essential to ensure that the array will stay safely locked together.

O-Line Bottom Cover



The O-Line Bottom Cover Plate

An O-Line array can be finished off with the addition of the optional bottom cover which fits to the base of the lowest O-Line module in the array to give a very neat finish. This may not be necessary for wall mounted arrays but is often essential for flown arrays where the bottom of the array is usually visible.



Bottom Cover mounting detail

The bottom cover is fitted via the raised mounting bracket on the inside of the cover which lines up with the holes on the O-Line bracket which are normally used to attach the linking plates. It uses the same nuts and bolts as the linking plates, you will always have a set of these left over as each block of four O-Line Starter Kits has a set to connect to the modules underneath it. Obviously the bottom modules in an array have nothing connected to them!

You will need the back cover of the lowest O-Line module removed ready to fit the cover.



Tip!

Remove the covers and the orange safety clips from the bottom two modules as this will make it much easier to fit the Allen key into the bolts to tighten them up.

Position the bottom cover in place under the lowest module. You will find that the mounting bracket will fit snugly between the O-Line steel brackets and the holes will line up with the linking plate holes. Fit the spare linking plate nuts and bolts starting with the lowest two and tighten with a 4mm Allen Key and a 10mm open ended spanner.



Tighten the fixing nuts and bolts

REPLACE ANY SAFETY CLIPS THAT YOU REMOVED! Then replace the backs covers of the modules. The system is now ready to be flown.



System ready for flying with bottom cover fitted

Recheck everything!

If you are inexperienced, or in any doubt at all, get an independent safety check.

ALWAYS double check that all Orange safety clips are in place as this is essential to ensure that the array will stay safely locked together.

System wiring

General

Your O-Line is delivered in blocks of 4 modules ready wired in parallel. These four-module blocks may be separated into smaller blocks or individual modules, linked and paralleled to other blocks or modules using short link wires - or series connected to other blocks or modules using the **series connector PCB** supplied with each four-module block (see illustration below).

The Series Connector PCB also provides an input termination.

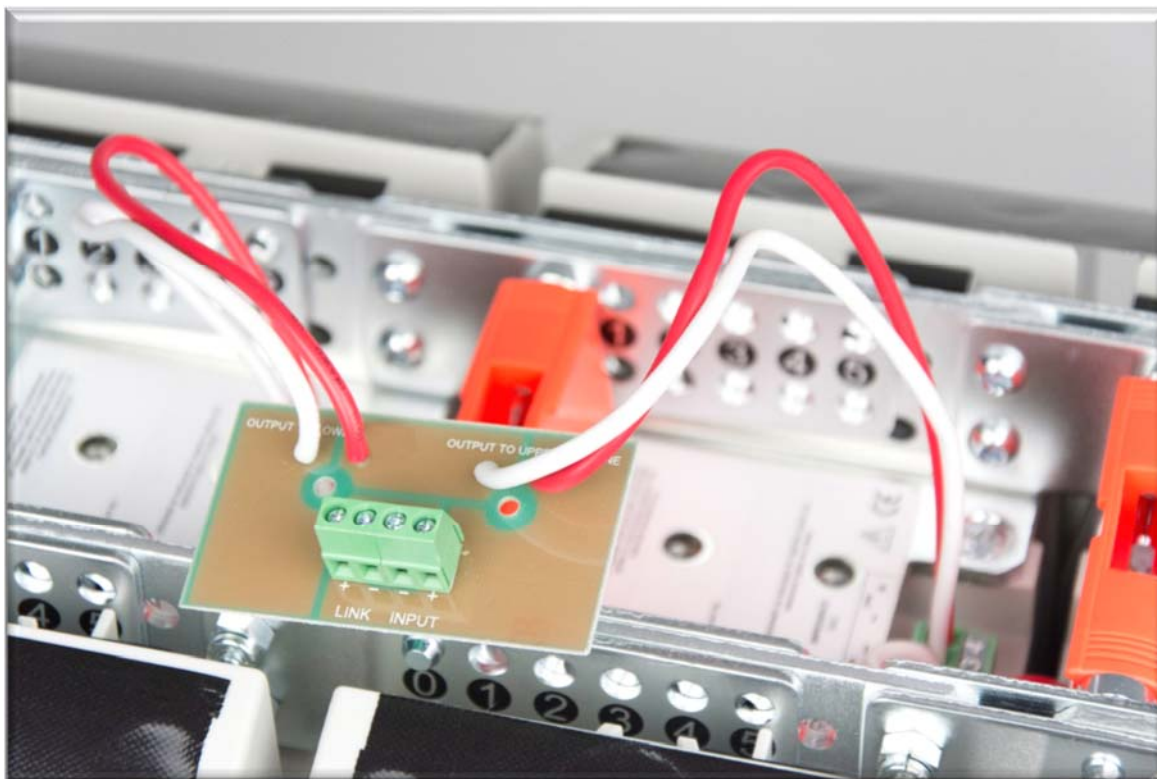

Note: White = negative, red = positive. Connections to upper and lower blocks are indicated on the circuit board

Route the connection cables under the orange safety clips to avoid crushing them when replacing the covers.

This allows the installer to build an array of appropriate length (we recommend 6% of each plane to be covered for good spectral balance) with electrical characteristics best suited to the Martin Audio power amplifier chosen.

Amplifier choices and limiter settings

The following chart shows Martin Audio power amplifier choices (indicated by dots) and Martin Audio DX1.5 or DX2 limiter settings (in red) to obtain optimal performance from the wide range of O-Line array sizes and patch configurations possible.

Single channels, two channel and four channel configurations are shown. Multi-channel configurations are useful where zone control may be required.

To avoid amplifier clipping (which dumps excessive power into the HF arrays in the form of odd-order harmonics) it is best to choose the highest power amplifier in the range indicated. Note that power amplifiers must be set to the industry standard maximum voltage gain of 32dB (x40) with a correctly limited DX1.5 or DX2 system controller to comply with warranty conditions.



	Amplifier										
	MA2 8Q	MA2 0	MA5 0Q	MA3 0	MA5 2K	MA9 6K	MA12K				
	8 ohms	360	600	750	900	1400	1500		2000		
	4 ohms	700	1000	1250	1500	2600	3000	4000			
	2 ohms	N/A	N/A	N/A	N/A	2800	4800	6000			
<p>↓ O-Line array ↓</p> <p>Indicates number of amp ch & impedance (per ch) Multiple modules connected in series (+) & parallel (//) (See patch sketches in "Powering your OmniLine")</p> <p>DX1.5 or DX2 controller must have 60Hz High Pass Filter. DX1.5 or DX2 controller must have correctly set long-term limiters and ClipLims (see right of chart →)</p> <p>Amplifiers must be set for 32dB (x40) voltage gain</p>									<p>DX0.5, DX1.5 or DX2 long-term limiter threshold (32dB amp gain)</p> <p>Attack = 16ms Decay = 256ms</p>		
	Array Power Rating (AES)									<p>Set DX1.5 or DX2 Clip Lim to 6dB</p>	
Single channel configuration											
1 module array	1ch 16 ohms	50W	•	•	•						-2dBu (1ch)
2 module array	1ch 8 ohms (2//)	100W	•	•	•						-2dBu (1ch)
4 module array	1ch 4 ohms (4//)	200W	•	•	•						-2dBu (1ch)
6 module array	1ch 2.67 ohms (6//)	300W									-2dBu (1ch)
6 module array	1ch 10.67 ohms ((3//)+(3//))	300W			•	•	•	•			+4dBu (1ch)
8 module array	1ch 8 ohms ((4//)+(4//))	400W			•	•	•	•			+4dBu (1ch)
12 module array	1ch 5.3 ohms ((6//)+(6//))	600W			•	•	•	•			+4dBu (1ch)
16 module array	1ch 4 ohms ((8//)+(8//))	800W			•	•	•	•			+4dBu (1ch)
24 module array	1ch 2.67 ohms ((6//)+(6//)//((6//)+(6//))	1200W					•	•	•		+4dBu (2ch)
Two channel configuration											
6 module array	2ch 5.34 ohms (2 x (3//))	150W + 150W	•	•	•	•					-2dBu (1ch)
8 module array	2ch 4 ohms (2 x (4//))	200W + 200W	•	•	•	•					-2dBu (1ch)
12 module array	2ch 2.67 ohms (2 x (6//))	300W + 300W									-2dBu (2ch)
16 module array	2ch 8 ohms (4//+4//per ch)	400W + 400W			•	•	•	•			+4dBu (1ch)
24 module array	2ch 5.3 ohms (6//+6//per ch)	600W + 600W			•	•	•	•			+4dBu (1ch)
Four channel configuration											
16 module array	4ch 4 ohms (4 x (4//))	4 x 200W	•		•						-2dBu (1ch)
24 module array	4ch 2.67 ohms (4 x (6//))	4 x 300W									-2dBu (1ch)
Note: O-Line modules are shipped in packs of 4											

(This chart is repeated full-size on the next page for easy reference)

Clip Limiter settings

Martin Audio loudspeakers are AES power rated. AES ratings allow for up to 6dB voltage (4 x power) instantaneous peaks. We therefore recommend that you set your DX1.5 or DX2 output channel Clip Limiters to +6dB.

Controller presets?

Note that we do not publish fixed presets for the O-Line – apart from recommending a standard 60Hz high pass filter and the required limiter settings. The **Display 2 software** – used to optimise the array shape – also generates the controller settings required for a flat in-situ system response or to meet your chosen house curve using the **Optimise EQ** function.



	Amplifier															
	MA2.8Q	MA2.0	MA5.0Q	MA3.0	MA5.2K	MA9.6K	MA12K	8 ohms	360	600	750	900	1400	1500	2000	
<p>↓ O-Line array ↓ Indicates number of amp ch & impedance (per ch) Multiple modules connected in series (+) & parallel ((//)) (See patch sketches in "Powering your OmniLine") DX1.5 or DX2 controller must have 60Hz High Pass Filter. DX1.5 or DX2 controller must have correctly set long-term limiters and ClipLims (see right of chart →) Amplifiers must be set for 32dB (x40) voltage gain</p>	<p>DX0.5, DX1.5 or DX2 long-term limiter threshold (32dB amp gain) Attack = 16ms Decay = 256ms</p>															
	<p>Array Power Rating (AES)</p>											<p>Set DX1.5 or DX2 Clip Lim to 6dB</p>				
<p>Single channel configuration</p>																
1 module array	1ch 16 ohms							•								-2dBu (1ch)
2 module array	1ch 8 ohms (2//)						•									-2dBu (1ch)
4 module array	1ch 4 ohms (4//)						•									-2dBu (1ch)
6 module array	1ch 2.67 ohms (6//)							•								-2dBu (1ch)
6 module array	1ch 10.67 ohms ((3//)+(3//))								•							+4dBu (1ch)
8 module array	1ch 8 ohms ((4//)+(4//))									•						+4dBu (1ch)
12 module array	1ch 5.3 ohms ((6//)+(6//))										•					+4dBu (1ch)
16 module array	1ch 4 ohms ((8//)+(8//))											•				+4dBu (1ch)
24 module array	1ch 2.67 ohms ((6//)+(6//)+(6//)+(6//))												•			+4dBu (2ch)
<p>Two channel configuration</p>																
6 module array	2ch 5.34 ohms (2 x (3//))							•								-2dBu (1ch)
8 module array	2ch 4 ohms (2 x (4//))							•								-2dBu (1ch)
12 module array	2ch 2.67 ohms (2 x (6//))								•							-2dBu (2ch)
16 module array	2ch 8 ohms (4//+4//per ch)									•						+4dBu (1ch)
24 module array	2ch 5.3 ohms (6//+6//per ch)										•					+4dBu (1ch)
<p>Four channel configuration</p>																
16 module array	4ch 4 ohms (4 x (4//))															-2dBu (1ch)
24 module array	4ch 2.67 ohms (4 x (6//))															-2dBu (1ch)
<p>Note: O-Line modules are shipped in packs of 4</p>																

O-Line array patches

Single O-Line modules are 16 ohm elements. Four modules are supplied in each carton. These four modules are connected in parallel to form a standard 4 ohm block but may be reconfigured, paralleled or series connected to provide a wide variety of series/parallel configurations chosen from the preceding chart.

Please note that if you don't understand series and parallel electrical configurations, you are strongly advised to enlist the advice of a professional sound system technician or experienced installer.

Single channel configurations

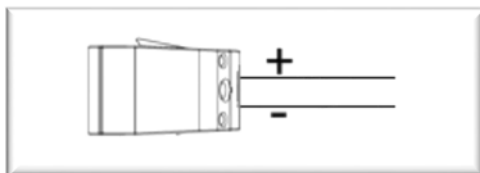

1 module array (16 ohms)

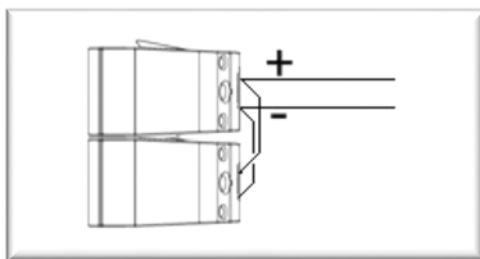

2 module array (8 ohms)

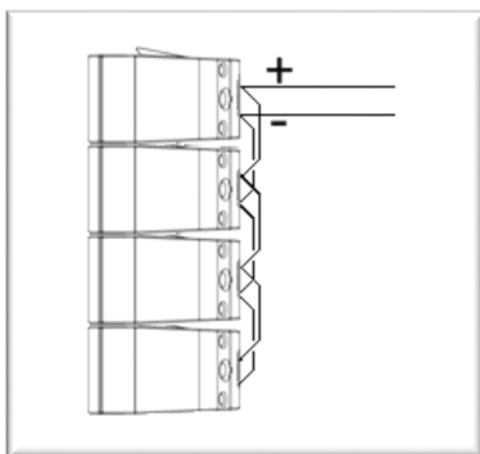

4 module array (4 ohms)

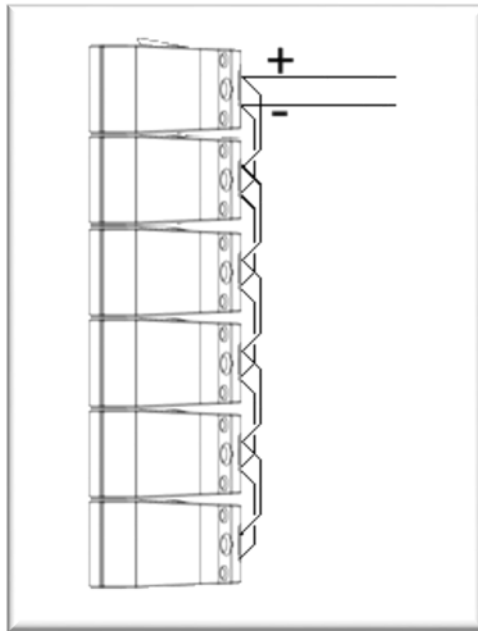

6 module array (2.67 ohms)

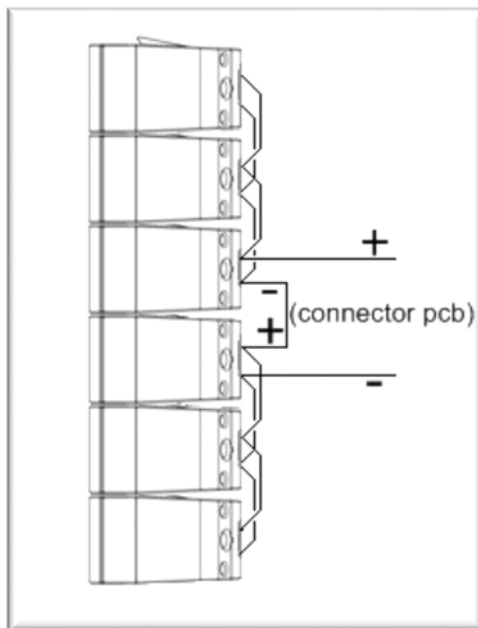

6 module array (10.67 ohms)

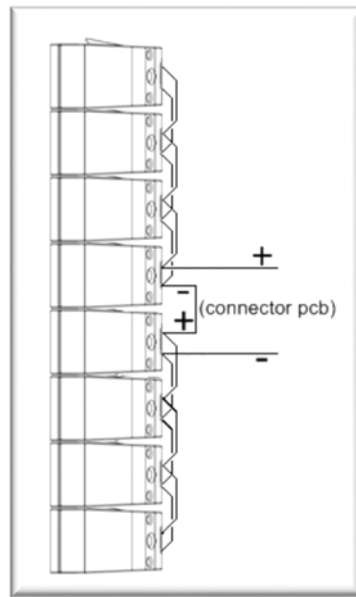

8 module array (8 ohms)

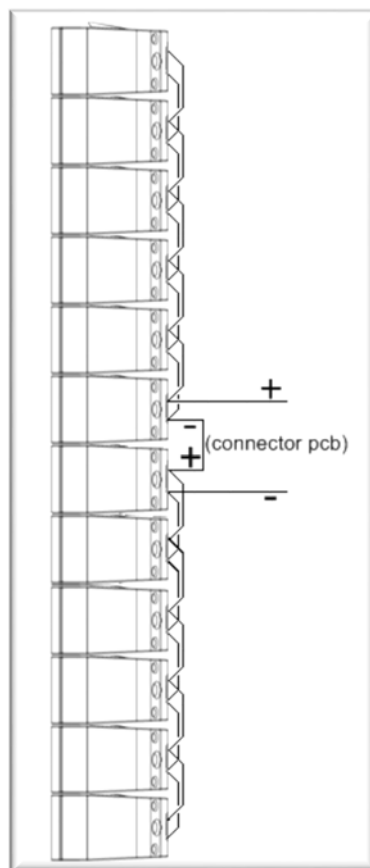

12 module array (5.3 ohms)

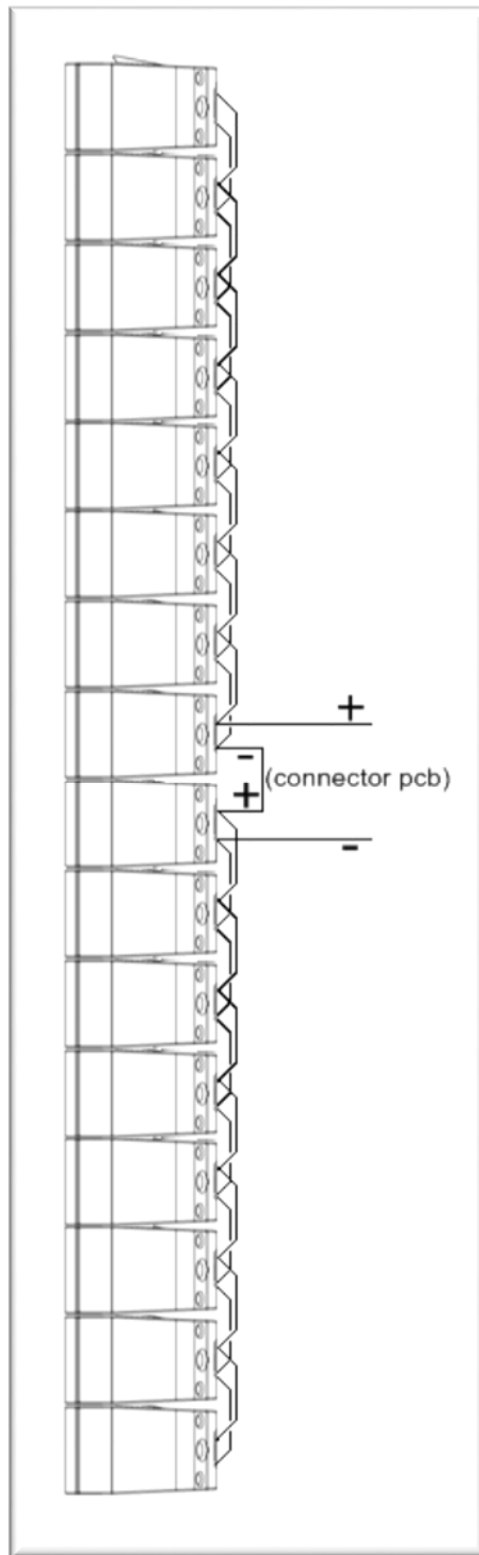

16 module array (4 ohms)

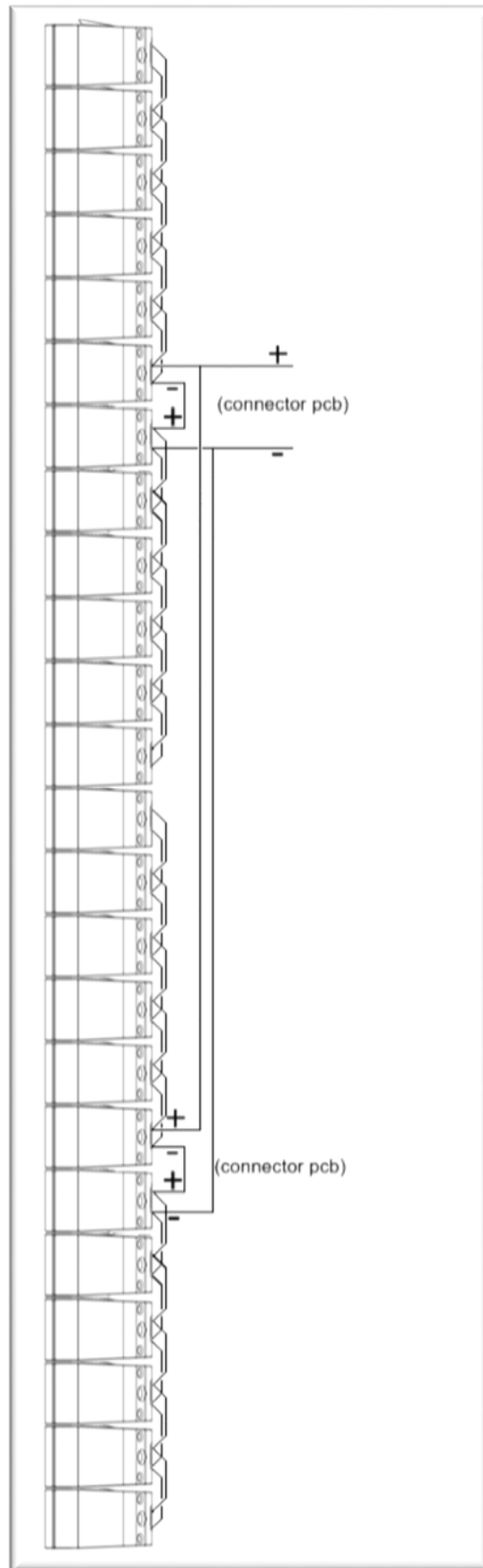

24 module array (2.67 ohms)

Two channel configurations

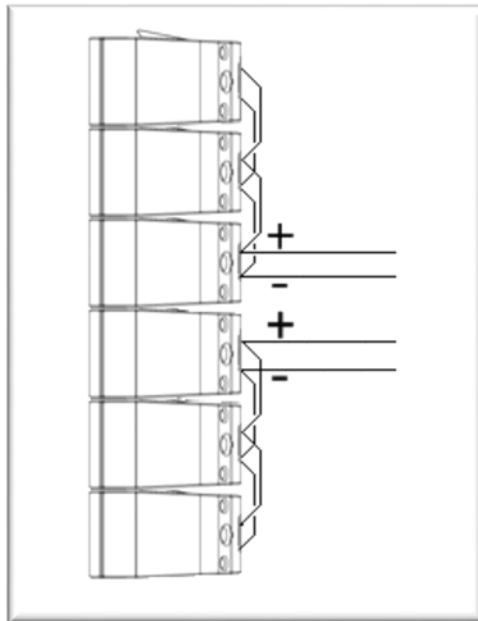

6 module array (5.34 ohms per channel)

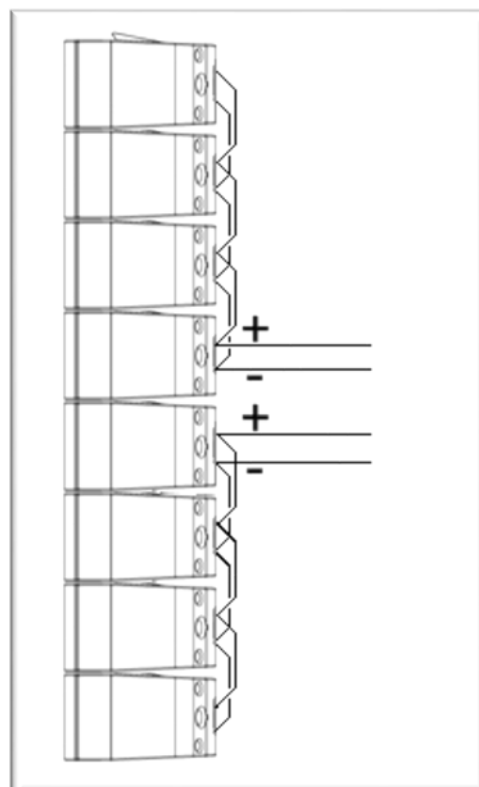

8 module array (4 ohms per channel)

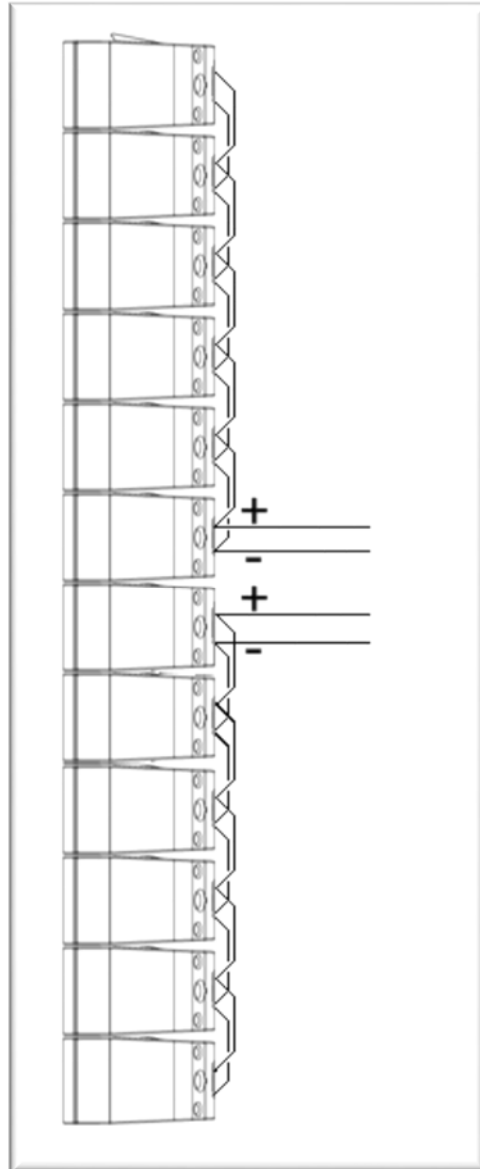

12 module array (2.67 ohms per channel)

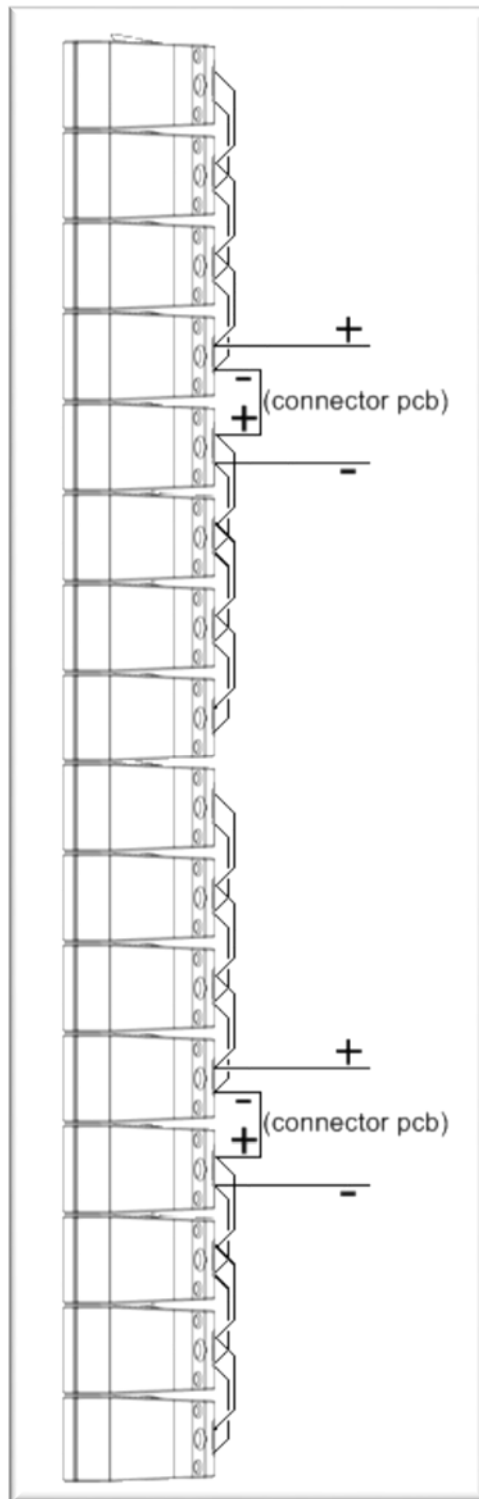

16 module array (8 ohms per channel)

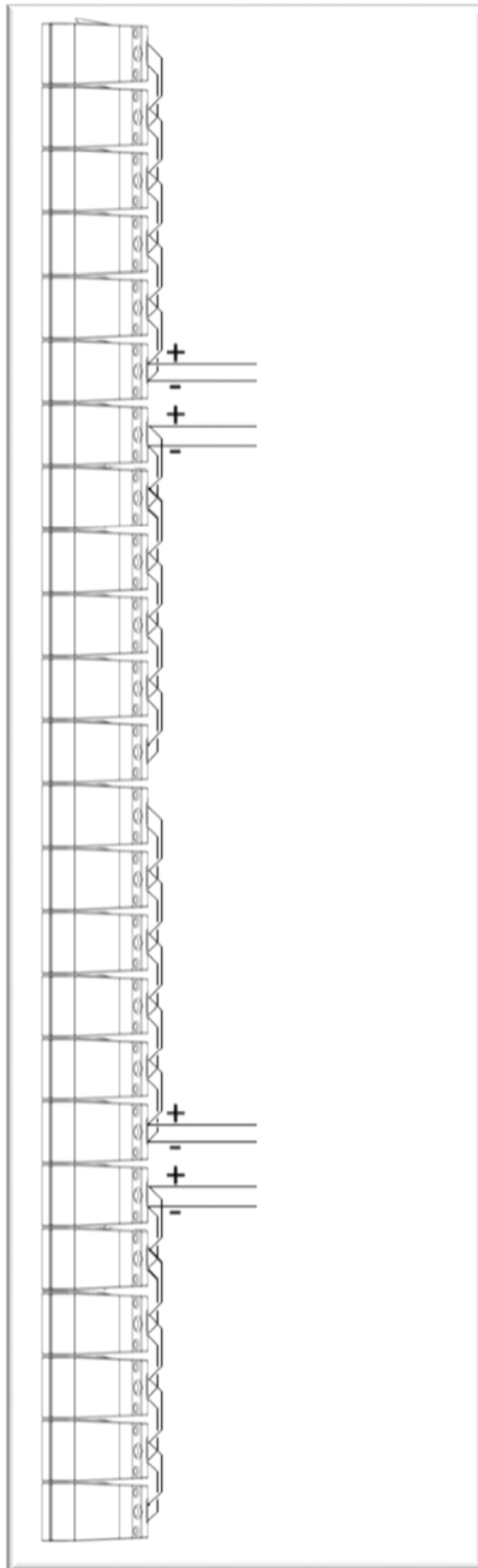

24 module array (5.3 ohms per channel)

Four channel configurations

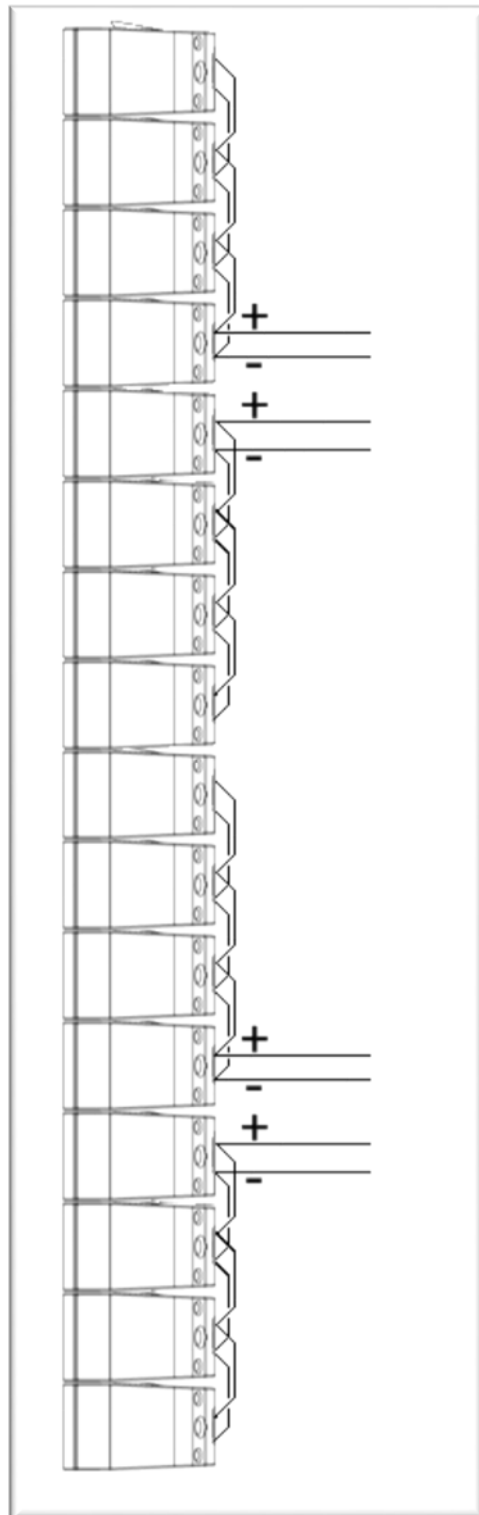

16 module array (4 ohms per channel)

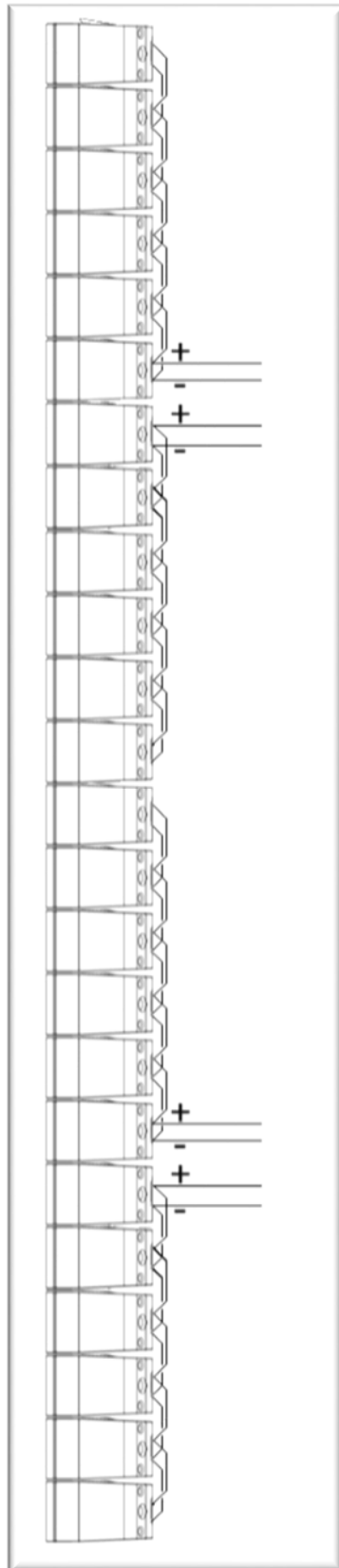

24 module array (2.67 ohms per channel)

Advanced Optimised System

To create O-Line arrays you use Martin Audio's unique Display 2 software. This calculates the inter-module angles and the DSP parameters using the same numerical optimisation techniques. Its sophisticated processing using FIR filters provides remarkable system coverage. The output from Display 2 is a file (a d2p file) containing all the processing coefficients. You can upload this file to an iKON amplifier using Martin Audio's Vu-Net software.

You have a choice of resolution:

- 8 box resolution is the entry level. Every block of 8 cabinets is powered by an individual amplifier channel. For example, a 16-box array would require 2-channels of amplification.
- 4 box resolution. A 16-box array would require 4 channels. You could power a stereo pair of 16-box arrays using a single iK81 (as this has eight channels).
- 2 box resolution. A 16-box array would require 8 channels.
- Single box resolution. A 16-box array would require 16 channels. You could power a pair of 16-box arrays using four iK81 amplifiers. This level of control is unique for an array in this market.

iK81



The iKON iK81 is an advanced 8-channel controller amplifier which combines very high power density with superb audio performance, state-of-the-art DSP and network control for WPM systems.

The iK81 can deliver a full 1250 watts per channel into 2, 4 or 8 ohms with all channels driven while remaining highly efficient. Its high efficiency reduces the energy drawn from the mains supply and ensures the power reserves needed to deliver superb sound under arduous live conditions.

Ethernet is used for system remote control and monitoring via Martin Audio's Vu-Net software application, while a user-friendly front panel interface allows full local control of all features. Dante digital audio network inputs are also provided for digital audio distribution and control.

Powerful DSP is fully integrated into the iK81 to provide a multitude of features. It also provides up to 1000 FIR filter taps @ 48kHz on each output channel, which is essential to implement DISPLAY's wide bandwidth optimisation process in the WPM line array. The iK81 employs comprehensive protection functions to maintain safe operating conditions of both the amplifier and the loudspeakers driven — including a sophisticated loudspeaker limiter suite which incorporates peak, RMS and excursion limiting, as well as multiband limiting for passive 2-way systems.

Display 2

Display 2 is a unique software application that calculates both inter-cabinet splay angles and the DSP parameters for optimum system performance in any given space. Unlike competitors systems, which generally use a basic geometric calculation to aim their arrays, Display 2 uses a completely revolutionary approach using an extremely accurate computer model of the array. It analyses the system performance in a drawing of the venue to precisely calculate the parameters for the system to get exactly the coverage you have specified. As a system designer you get to determine exactly how you would like the system to perform in the space; the spl contour from the front to the back of your audience region, how much spill into non-audience areas is acceptable and even specify designated "hard-avoid" areas that the system will actively process to reduce spill to a minimum. This is great for producing a quiet stage or for reducing noise pollution off-site at outdoor events.

The application is very straightforward to use taking you through a series of steps in a logical order. In fact it won't allow you to attempt to design a system in the wrong order; steps need to be completed one after the other in the correct order making it very straightforward to design an array that will perform to its maximum potential.



DISPLAY opens with a Dashboard at the top of the screen the initial view prompting you to specify your array which is the first step of the design process. O-Line is available along with the Multicellular and Wavefront Precision families of products. You next specify how your array will be deployed, flown is the option for O-Line, specify the number of cabinets and give the array a name.

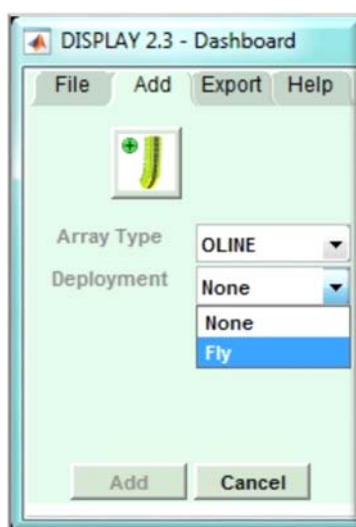

The dashboard changes to show the tabs from left and right in the order in which the design will be completed.



First a 2D slice of the venue is created, the coverage within the venue is specified, the splay angles calculated. A rigging report allows you to deploy the array and whilst that is being done the EQ coefficients are calculated. Finally an SPL report gives detailed information showing exactly how the system will perform. The computer model is accurate to within +/- 1dB of actual measured results so the SPL tab is a reliable overview of how well your system design will cover the space.

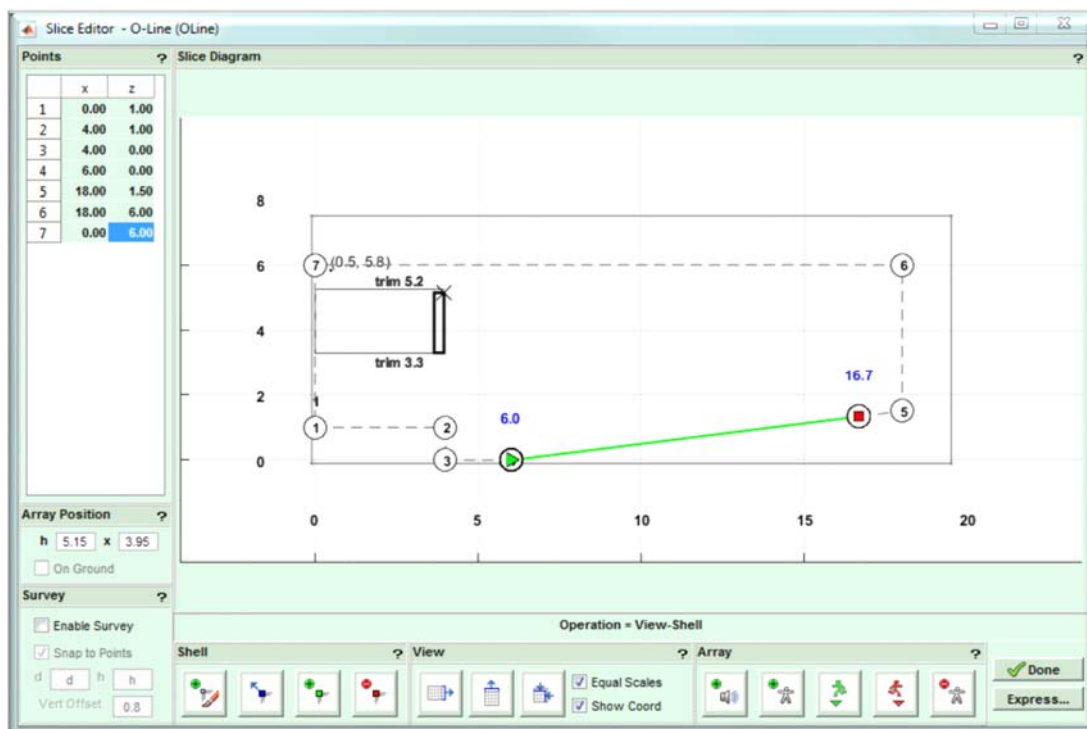

The 2D slice is either drawn from scratch or you can also import a shell drawing from a previous project if you are working in a venue you have visited previously. The slice is a side view of the venue. It is drawn anticlockwise starting at the back of the stage and clicking to define the position of vertices that define all of the planes within the venue. This doesn't have to be done accurately as you can refine the precise position of the points working from architects drawings or measurements you have taken yourself. The array is positioned and the audience region specified from start to finish.



The coverage tab shows your 2D model with the planes refined into three types;-audience in green, non-audience in red and hard avoid in blue. Each dot represents a virtual microphone position at which the software will take response measurements using the integral computer model. The dots in the critical audience region are closer together for greater accuracy and are spaced closer together at the start of the audience region to mirror how each region is covered by sections of the array. The

audience offset can be edited; standing, sitting or a custom offset of your choice and each region can be edited, perhaps changing a section under a balcony from audience to non-audience for example.

The SPL profile can be modified and the environmental conditions entered to allow the optimisation to compensate for air absorption, particularly critical for outdoor events.

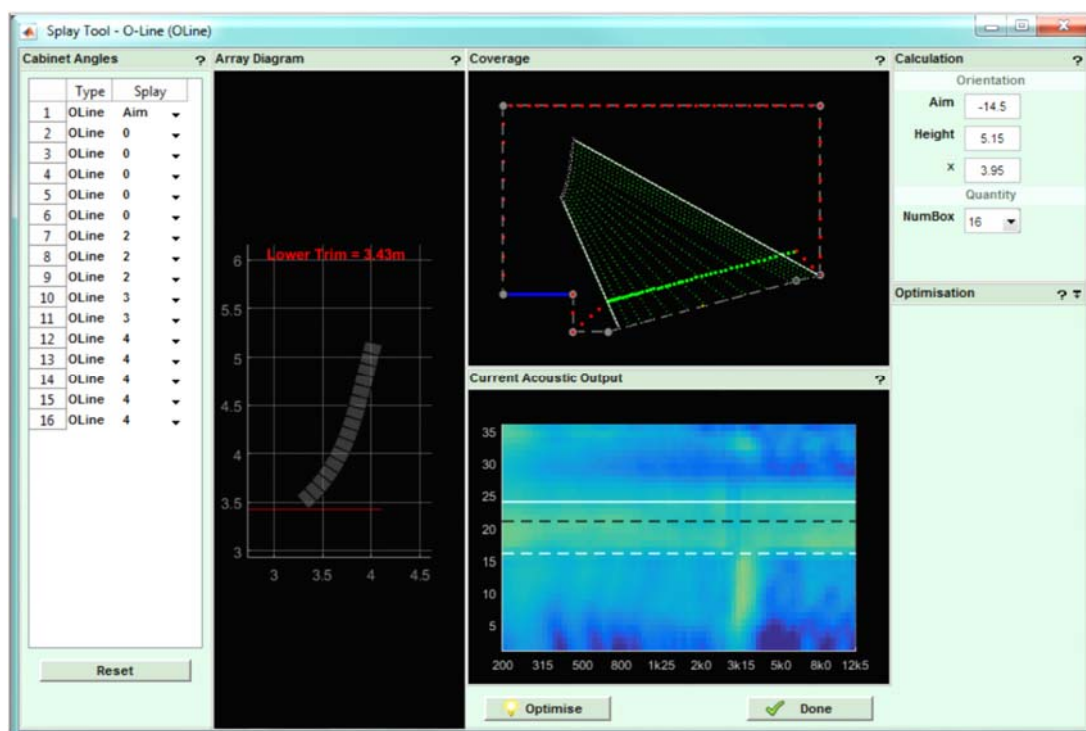

In the splay tab you can refine the quantity and position of the array before the system optimises the inter-cabinet splay angles and the “aim” angle for the flying frame.

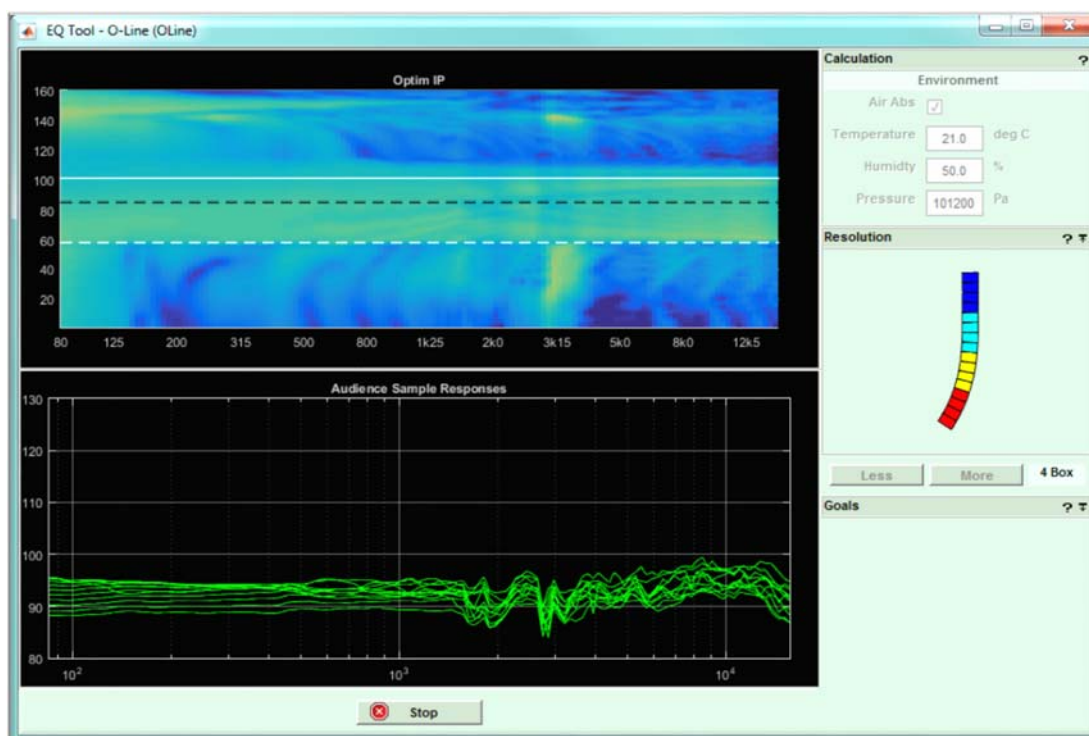

With the physical deployment underway you can progress to optimise the EQ. Again you can enter the environmental conditions and can balance the three goals of response in your audience region, leakage to non-audience and the hard avoid performance.

By default each are given equal importance but if your application demands particular emphasis on any one of these parameters they can be given greater importance.

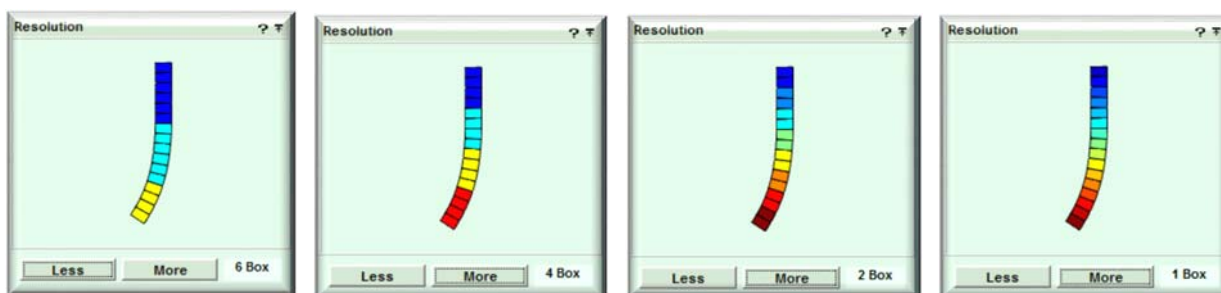

The resolution is entered selecting any number from 8 box to 1 box.

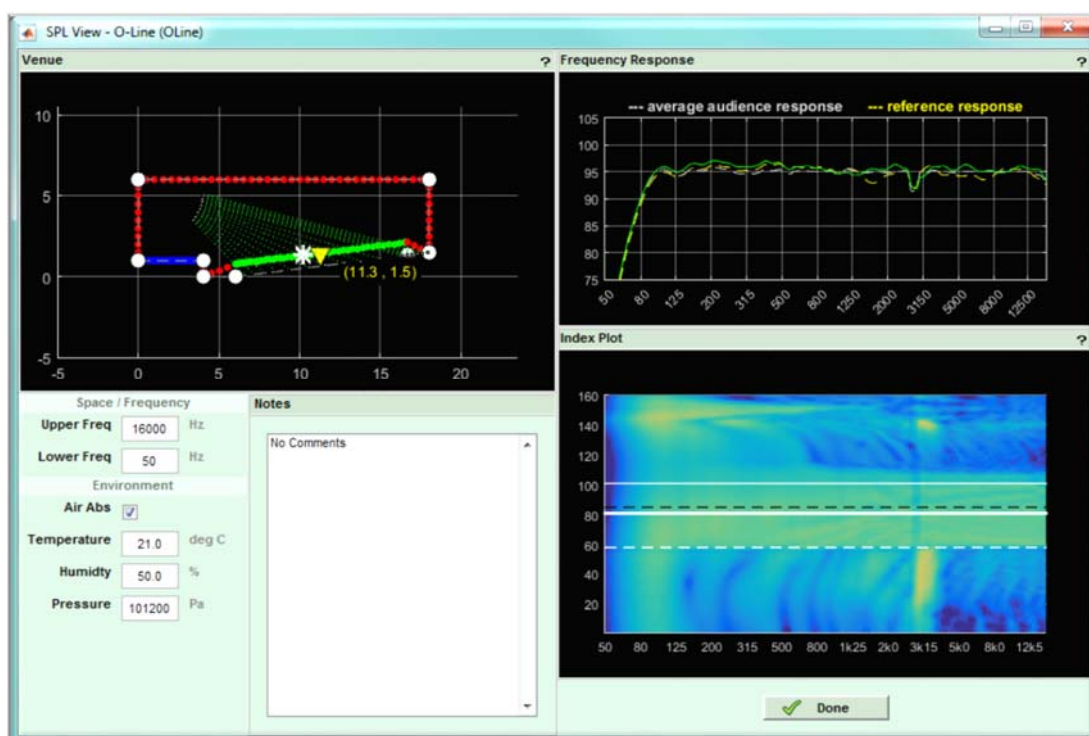

The SPL tab shows the system performance. The entire venue SPL is displayed on an index plot with frequency along the horizontal axis and position within the venue along the vertical. SPL is indicated with colour, blue being quietest moving through the colour spectrum to red which is the loudest. You can move the cursor around the Index Plot and the position is shown on the 2D slice of the venue top left whilst showing the frequency response at that position on the graph on the right.

The final stage is to export your design. You can produce a printable rigging report, a wire-frame 3D model of the array, export 3D data for use with EASE and most importantly export the project as a D2P file which can be uploaded directly to an iKON amplifier.

To download Display 2, visit the Martin Audio website here at <https://martin-audio.com/support/software>. There is also a comprehensive user guide to take you through the design process in detail. We strongly recommend that you read the user guide to fully understand the application.

Vu-Net

Vu-Net is Martin Audio's application which is used to connect to iKon amplifiers and a many Martin Audio products. This makes it possible to create a system with products from several different ranges and control and monitor them from a single software platform.

Connection to iKon amplifiers is made over a standard Ethernet network using off the shelf networking products so remote access to control O-Line systems is extremely straightforward if required. Complex systems with large numbers of amplifiers can easily be created using standard network switches, the system by default is configured with dynamic IP addressing so DHCP support will be required however a static IP configuration is also easily enabled.

Vu-Net is used to upload the O-Line optimisation presets created using Display 2 into the amplifiers which will automatically create a thumbnail of the O-Line array that has been designed. Once the array has been created, all of the amplifier functions are available for control to make any changes you may need to routing, crossover point, phase, delay or system EQ. the application has an intuitive GUI making is very quick and easy to get to grips with if you have used any computer based processing software. Once the system is configured the amplifiers can be kept on-line to give comprehensive monitoring of the system performance.

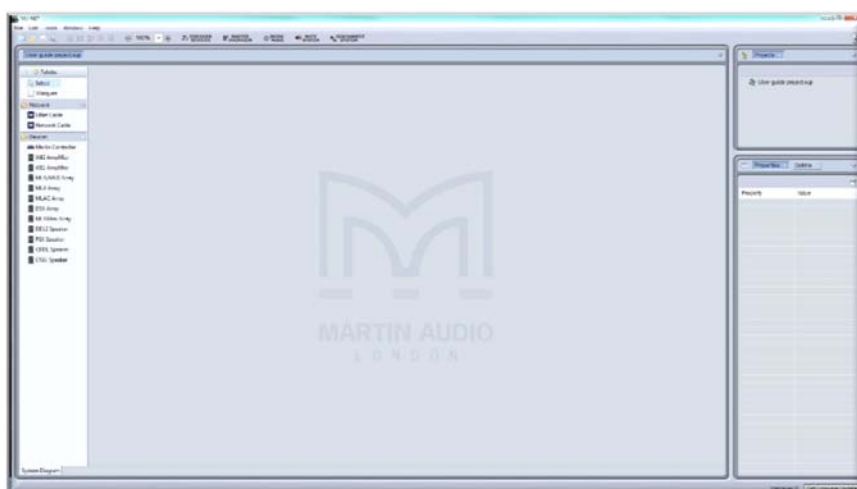

The application opens with a blank System diagram. It is possible to add products manually using the Palette on the left but this has limited use, in practical applications, the Discover Devices button is used



The application searches the network for all Vu-Net enabled devices and will run an installation wizard to add them to the Vu-Net project

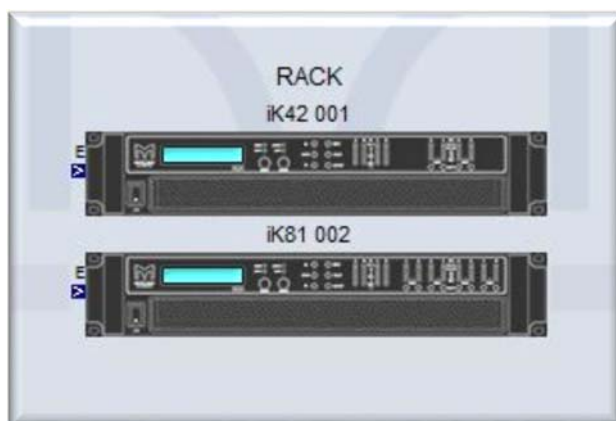

The next stage is to right click on the amplifiers to access the Preset Manager

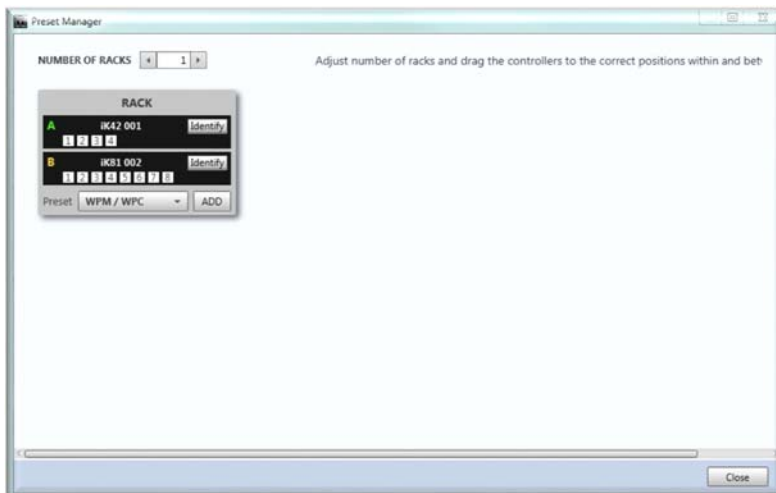

From here the system allows you to select the appropriate Preset to drive your O-Line array

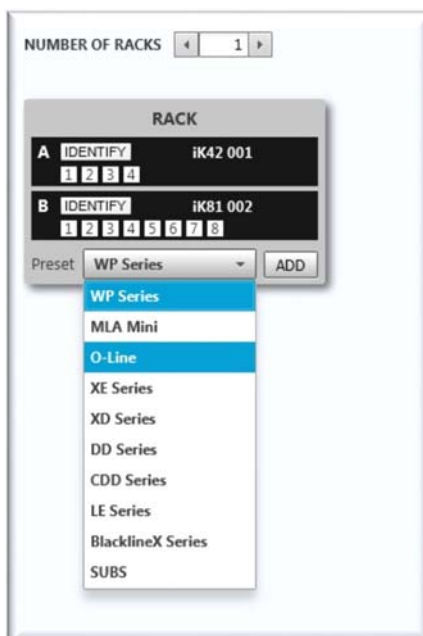

Next you navigate to select the d2p file created using Display 2, select the Preset from the file (if you created more than one option in the optimisation) and select the first channel of the amplifier into which you wish to upload the file.



Click on 'Load' and the file is uploaded to the amplifier and an icon of your array is added to the project. For a stereo system, repeat the process selecting the next amplifier channel from which you need to drive the second array

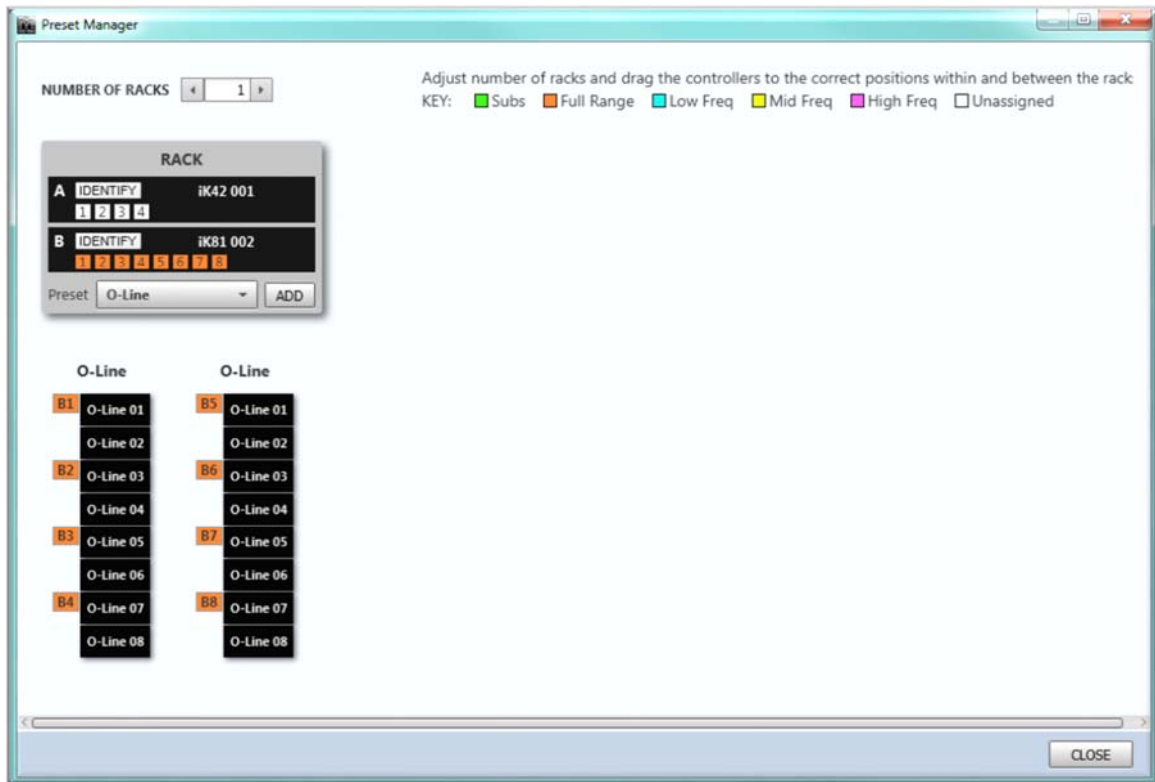

You can now return to the project system diagram, double click on the amplifiers and edit the system to suit your application, perhaps adding some delay to align subwoofers

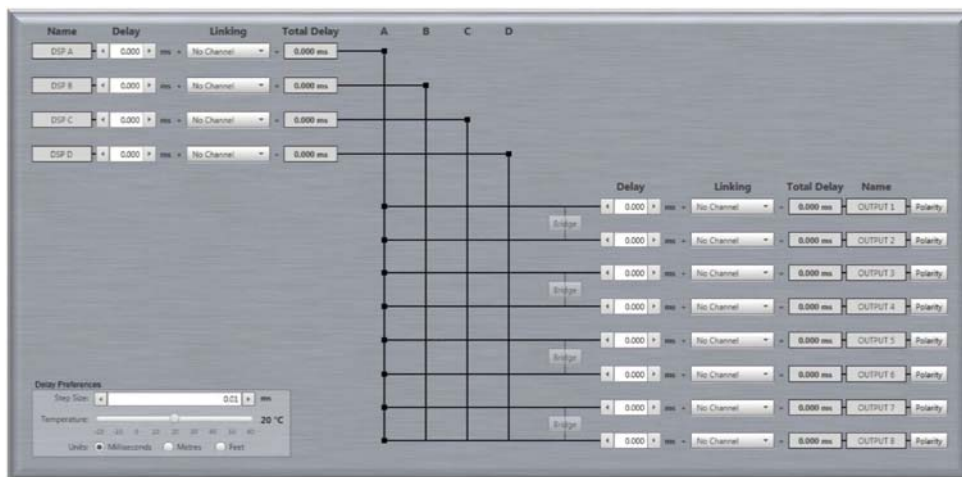

Input EQ can be adjusted to suit your preferences and to compensate for any difficult acoustics



The output EQ is greyed out as it is used to apply the EQ created by your Display project, however the high pass filter is available for adjustment so you can determine the crossover point between the O-Line array and subwoofers if used.



Comprehensive ganging is available so you can ensure that stereo arrays remain completely identical

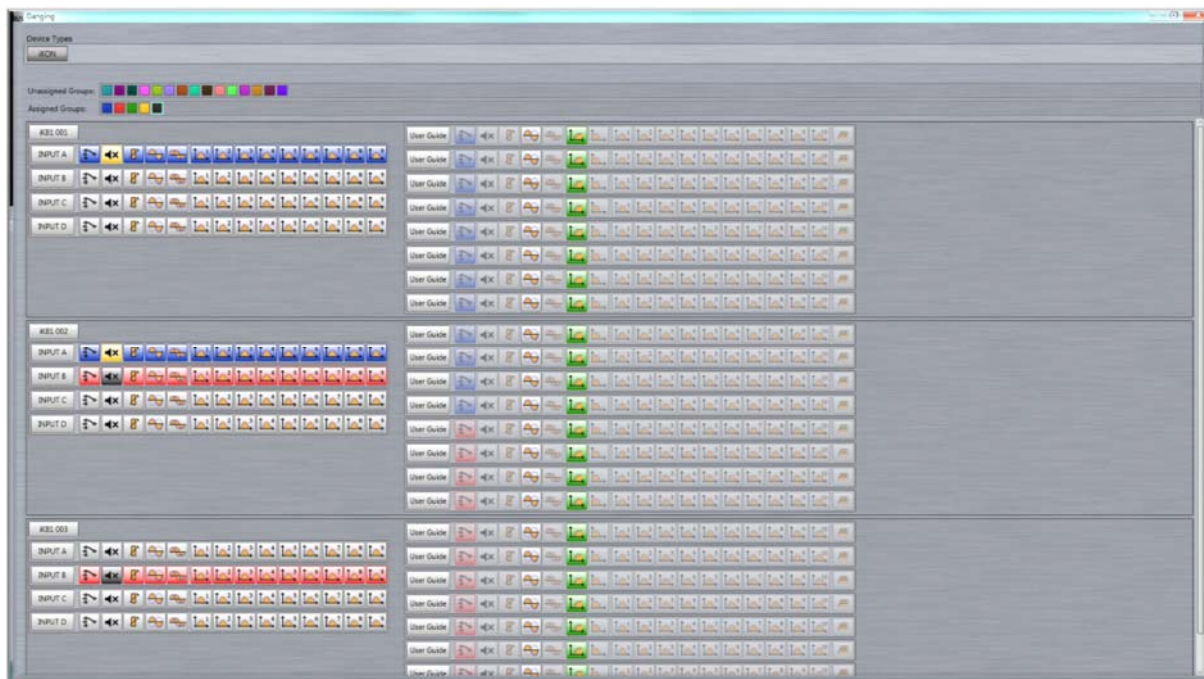

Once the system is configured to your satisfaction a Master Overview gives a complete picture of even the most complex system allowing you to monitor all metering and access commonly needed functions such as gain and mute.

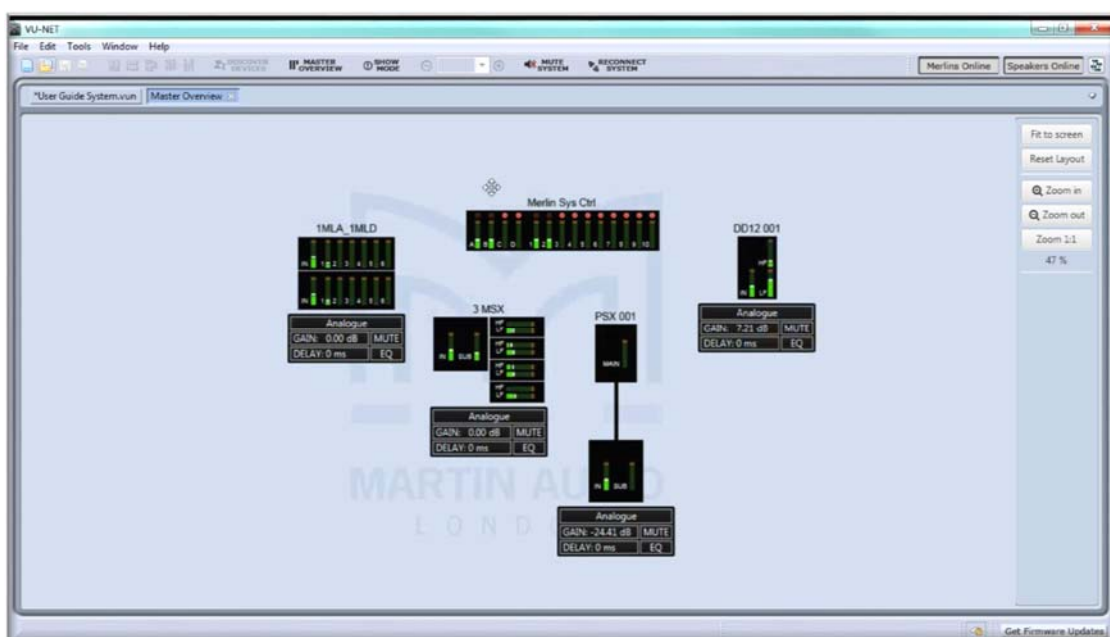

Vu-Net is a free download from the Software page of the Martin Audio website here;-

<https://martin-audio.com/support/software>

It is a comprehensive application with a host of functions to enable control and monitoring of almost every parameter of a system. For full details we would strongly recommend downloading the Vu-Net User Guide which can be found on the same page as the application download, this is an excellent reference to fully understand the use of Vu-Net.

Wiring Advanced Systems

Wiring optimised system requires a little more system preparation and planning than a conventionally configured array. Multi-way speaker cable may be required depending on the size of the array and degree of resolution that has been selected in the Display 2 project. Note that each individual O-Line module is rated at a modest 50W AES so unless cables runs are very long you can use speaker cable with a smaller than usual cross section, 1.5mm² or even 1mm² may be acceptable. This should help avoid bulky speaker cables looms for arrays with a high resolution.

The following wiring diagrams are for arrays that are comprised of multiples of four modules as that is how O-Line is sold. It is however perfectly acceptable to use arrays of any number from 1 to 32 modules. The wiring guides are intended to be used as a template, they can be scaled up or down to suit the exact size of array to be deployed. Note that where the resolution selected is not an exact division of the number of modules in the array- 10 modules with a 3-box resolution for example- the "odd" number module(s) will always be the one(s) at the bottom so for the 10 module array, the first three at the top are run in parallel, then the next three down (modules 4, 5 & 6), then the next three (modules 7, 8 & 9) with the final module at the bottom run from its own channel, therefore four channels of amplification and DSP are required (half of an iK81).

4-Module Arrays

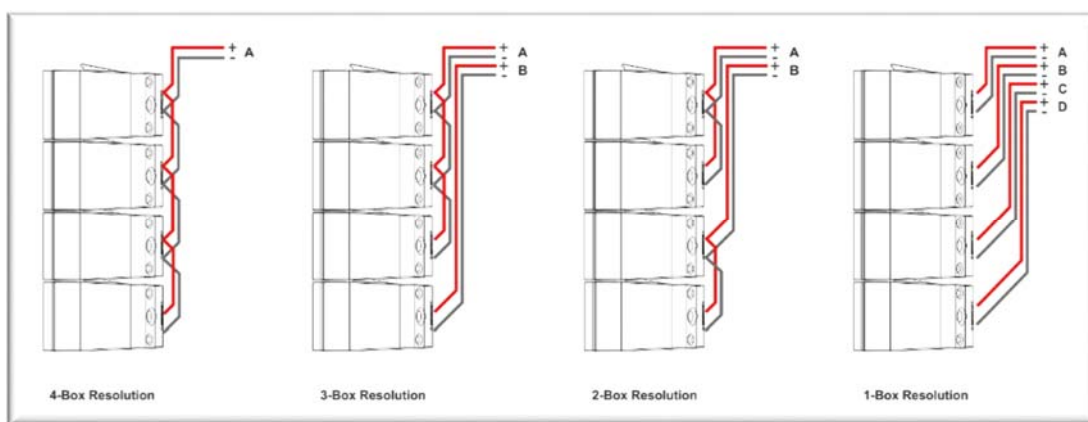

8-Module Arrays

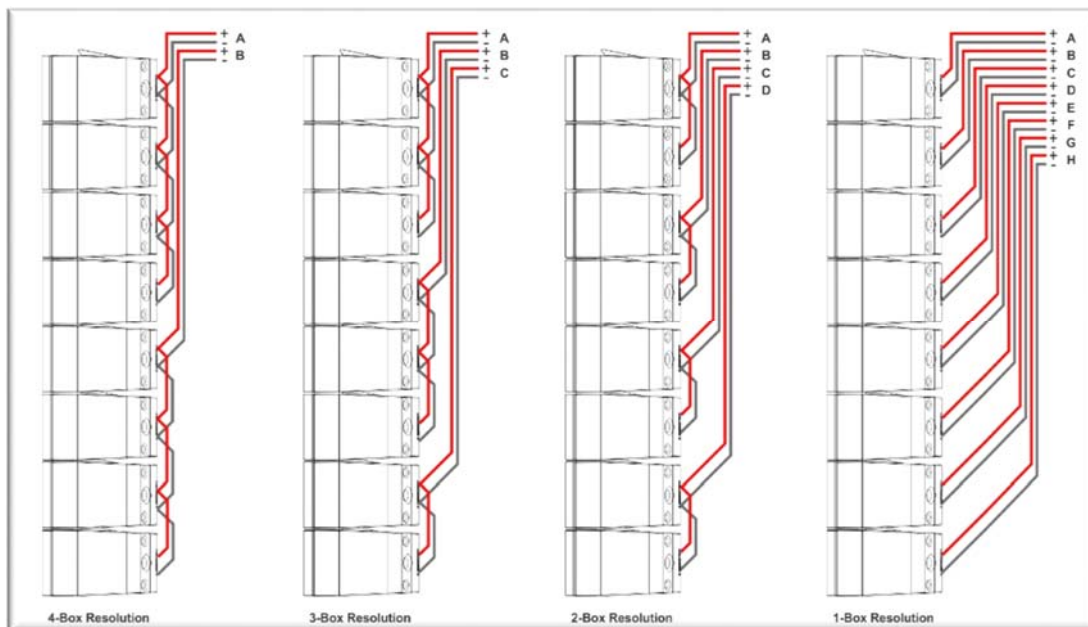

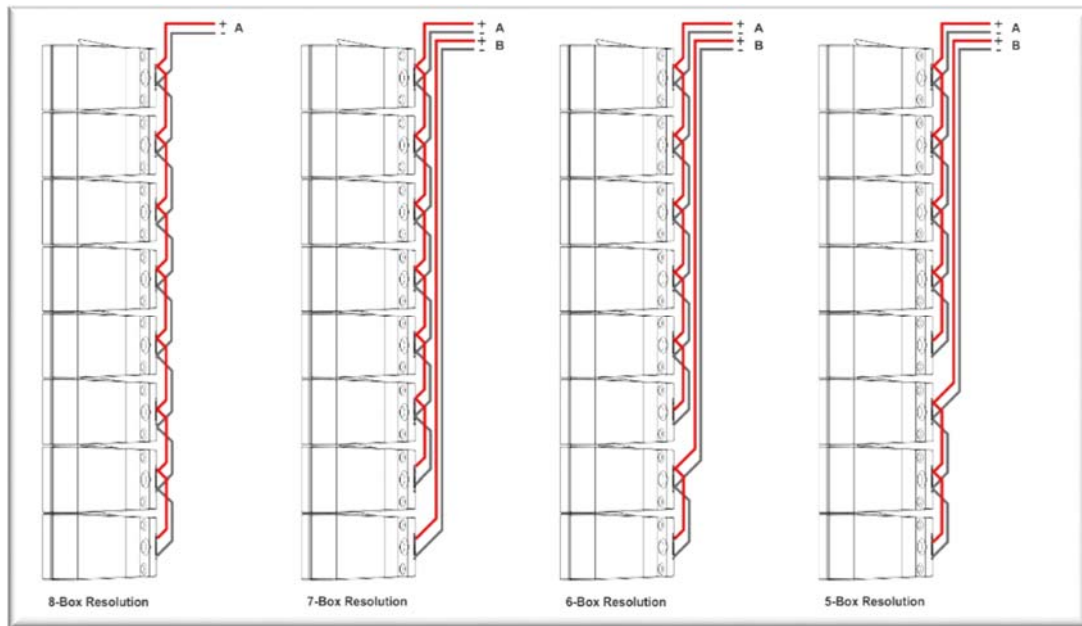

12 Module Arrays

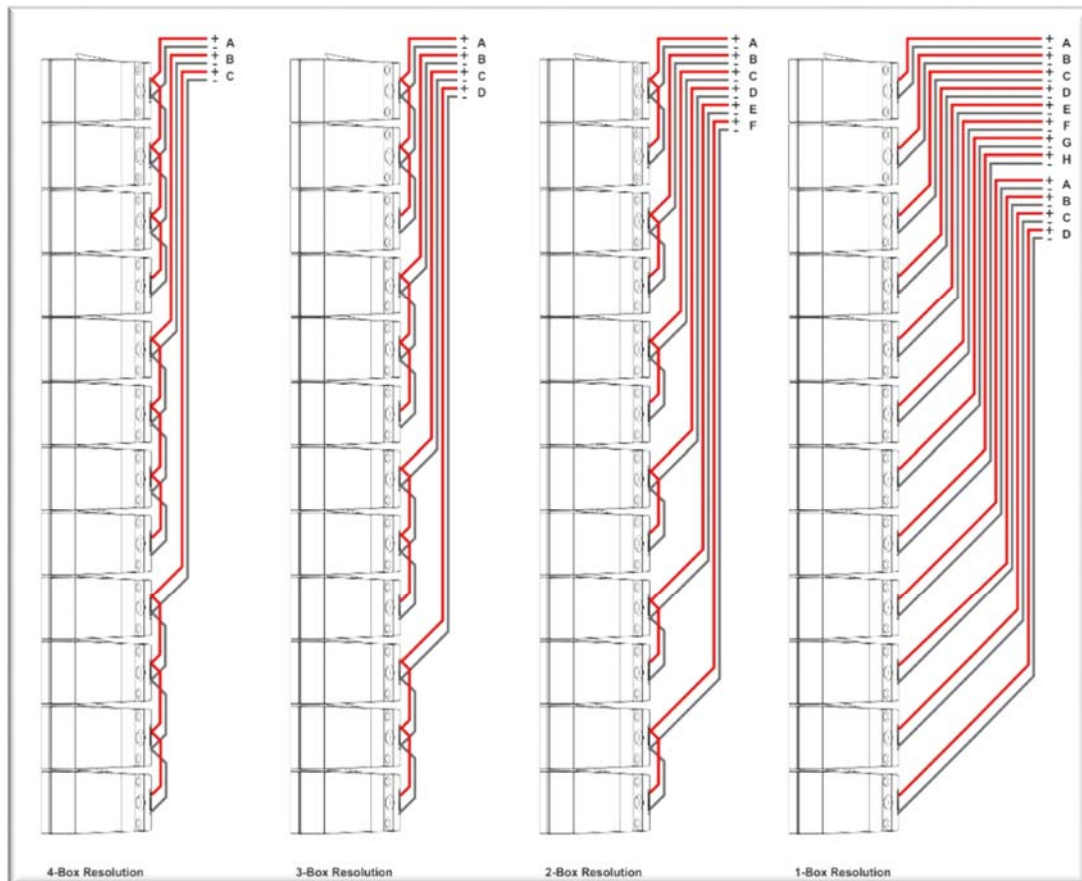

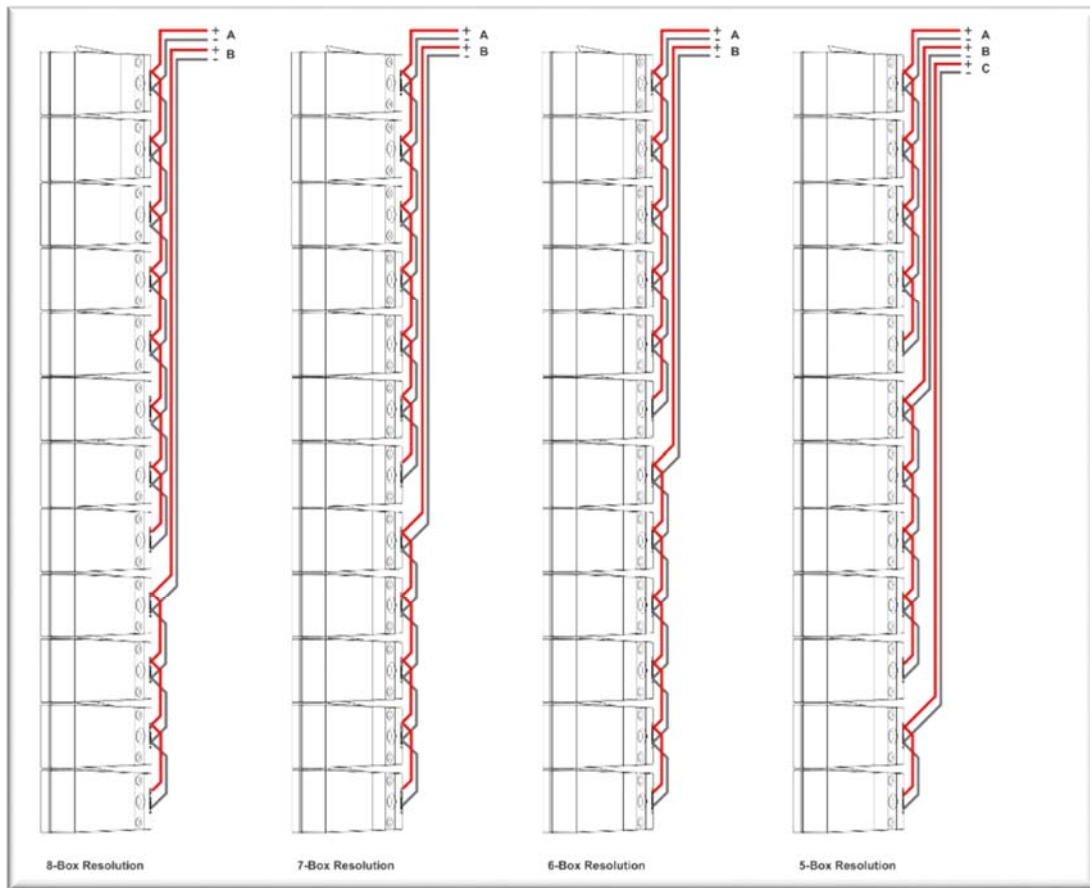

16 Module Arrays

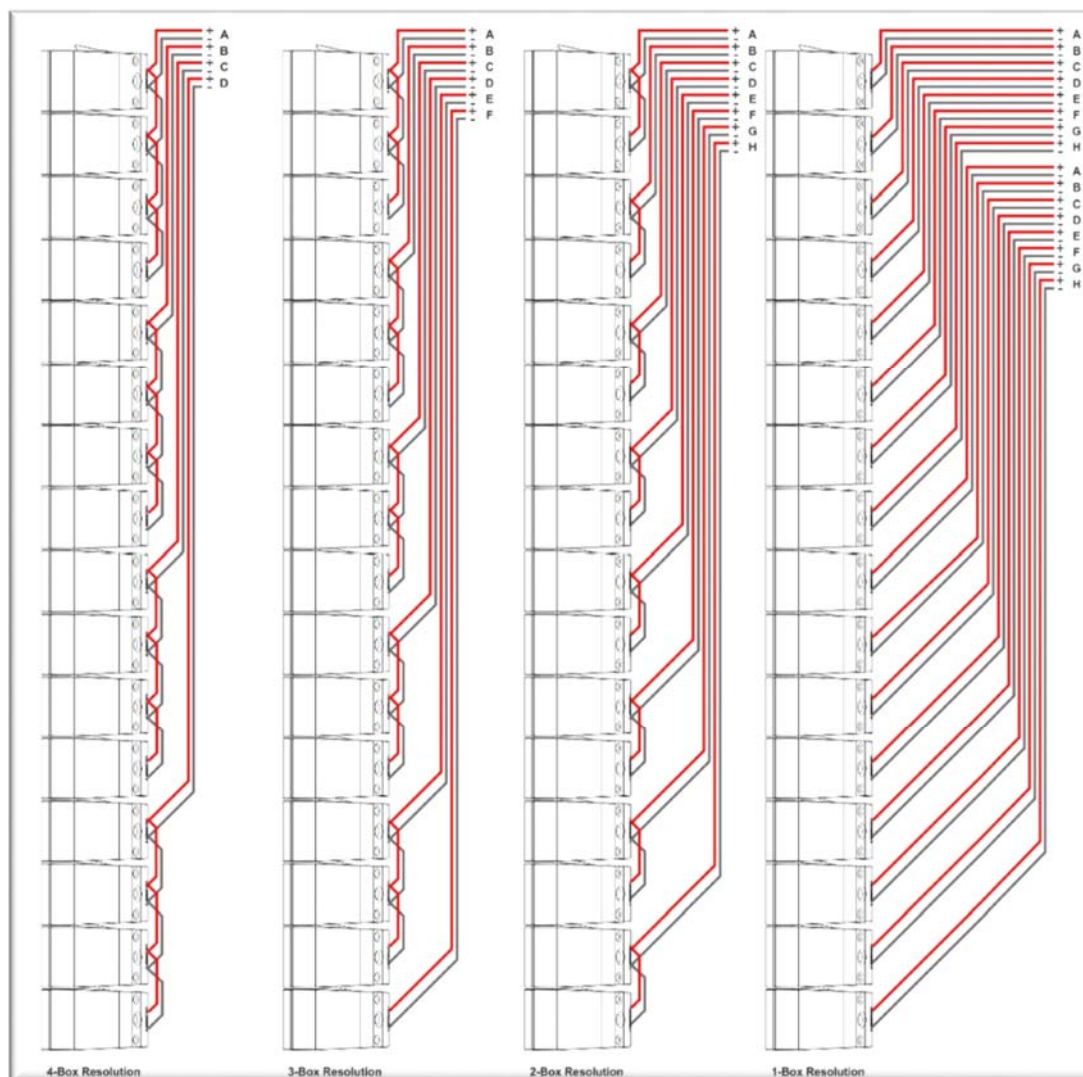

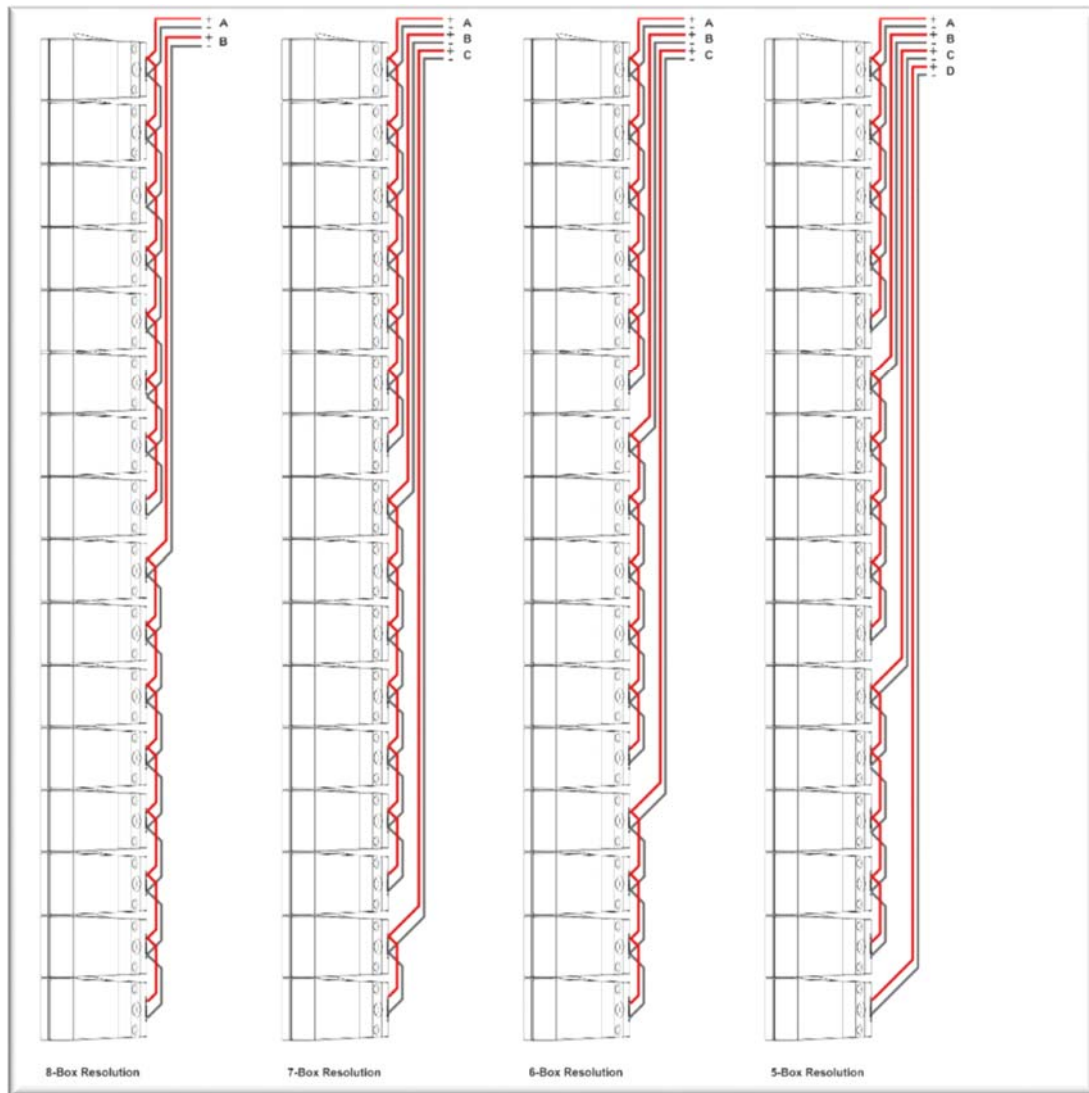

Wiring Individual modules

O-Line is supplied in blocks of four modules which are not only physically linked but also electrically linked in parallel. This is perfect for 4-box resolution but any other configuration you will need to modify the connections to suit your array configuration.

O-Line connections are made using red and white tri-rated cable to the Phoenix connectors on each module.

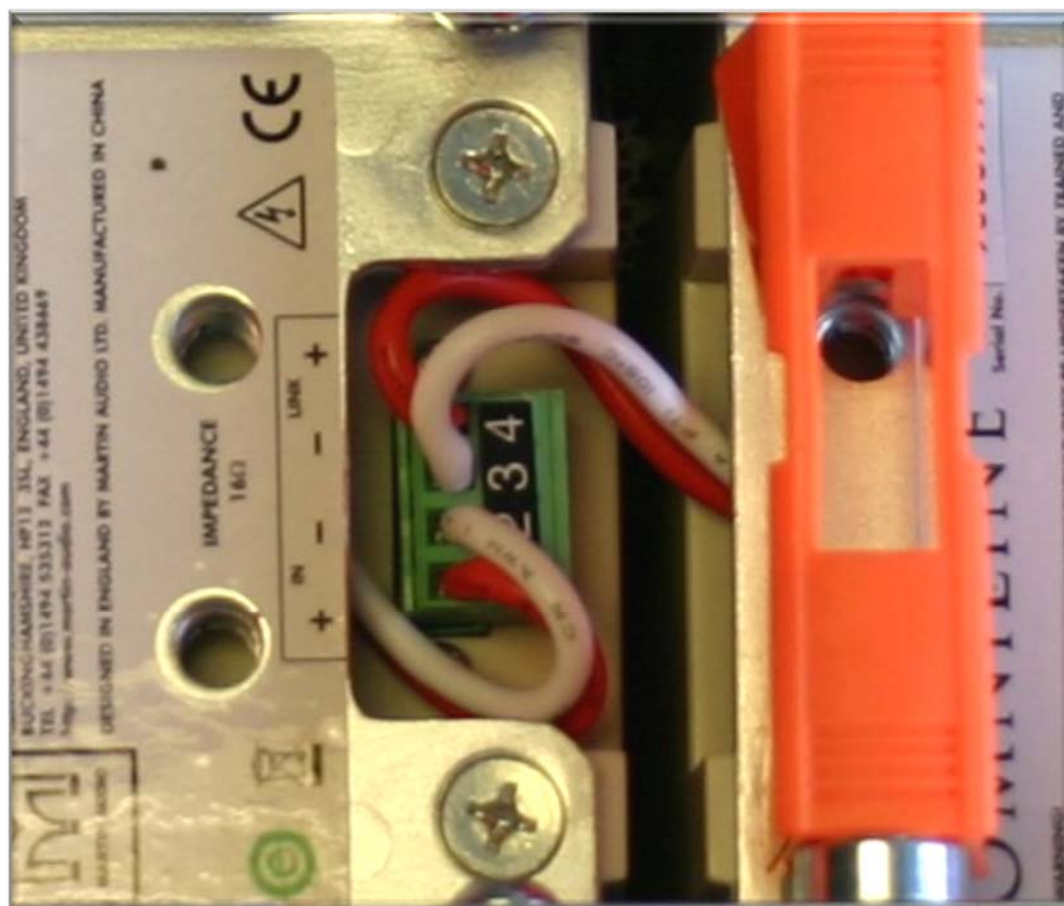

There are four connections on each Phoenix, this allows an input connection and a parallel output to make linking to adjacent modules very straightforward. The connections are positive (red) on the outside pins and negative (white) on the two middle pins. The cables supplied are run underneath the rigging brackets to keep the module wiring neat. If you need to remove a link between modules to modify the wiring the process is simple enough:

As the connector is tacked in a recess under the rigging bracket, it is a little difficult to access, it is best removed with a pair of long nose pliers. There is enough slack on the connecting wires to pull the connector clear so you can access the screws in the top of the connector to loosen and remove any of the wires and to add new connections direct from an amplifier channel. You will need a 2mm flat head screwdriver.

To completely remove any of the links you will obviously need to disconnect both ends of both the red and white wires. Although the wires run under the rigging bracket you should be able to pull them clear from the module which is best done again using long nose pliers.

Don't forget to firmly push home all Phoenix connectors once you have re-configured the wiring as required.