

# **EVERSE Battery-powered Loudspeaker**

EVERSE 8, EVERSE 12

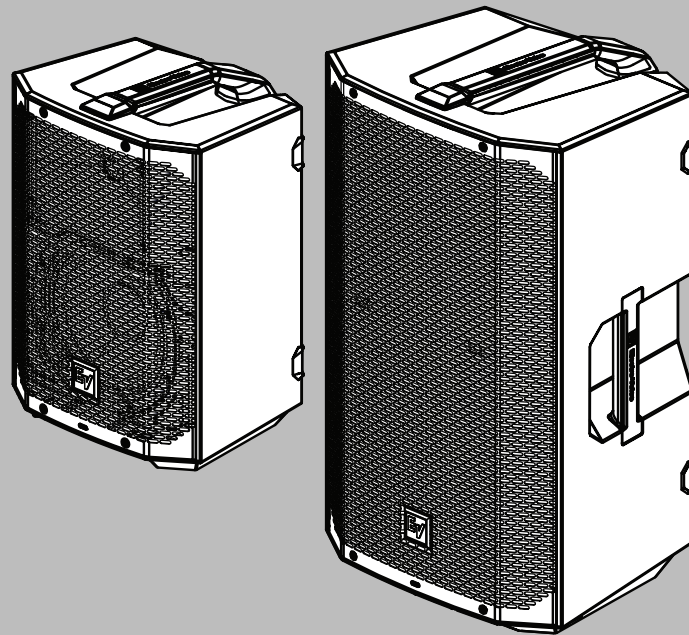







## Table of contents

<b>1</b>	<b>Safety</b>	<b>4</b>
1.1	Important safety instructions	4
1.2	Battery and internal charger safety rules	7
<b>2</b>	<b>Description</b>	<b>10</b>
2.1	Short information	10
2.2	System features	11
2.3	Quick setup	12
<b>3</b>	<b>Pairing the QuickSmart Mobile app</b>	<b>14</b>
<b>4</b>	<b>Operation</b>	<b>17</b>
4.1	Installation and charging of battery pack	17
4.2	Weatherization	18
4.3	Installation of weatherized input cover	22
4.4	Tripod or pole mount	23
4.5	Floor monitor & kickback	25
<b>5</b>	<b>Amplifier DSP</b>	<b>27</b>
5.1	Amplifier DSP controls	27
5.2	System status	28
5.3	DSP controls	29
5.3.1	Loudspeaker DSP control menu	30
<b>6</b>	<b>Input &amp; Mixer operation</b>	<b>43</b>
6.1	INPUT DSP control menu	43
<b>7</b>	<b>Recommended configurations</b>	<b>49</b>
7.1	Connecting with mobile device	49
7.2	Street musician performance	50
7.3	Bluetooth true wireless stereo (TWS)	51
7.4	Using as monitor	52
<b>8</b>	<b>Troubleshooting</b>	<b>53</b>
<b>9</b>	<b>Technical data</b>	<b>56</b>
<b>10</b>	<b>Appendices</b>	<b>59</b>
10.1	Effects (FX) list	59
10.2	FCC information	60
10.3	Simplified Declaration of Conformity (sDoC)	61
10.4	Certifications	63
10.5	OSS Licenses	67
10.5.1	Components overview	67
10.5.2	The Licenses	67
10.6	Notices	85

# 1 Safety

## 1.1 Important safety instructions

 <p><b>WARNING:</b> TO REDUCE THE RISK OF FIRE OR ELECTRIC SHOCK, DO NOT OVEREXPOSE THIS APPLIANCE TO RAIN OR MOISTURE</p> <p><b>AVIS:</b> RISQUE DE CHOC ELECTRIQUE, NE PAS OUVRIR.</p> <p><b>WARNING:</b> THE MAINS PLUG OR AC INLET IS USED AS A DISCONNECT DEVICE. THE DISCONNECT DEVICE SHALL REMAIN READILY OPERABLE.</p> <p><b>WARNING:</b> CONNECT ONLY TO MAINS SOCKET WITH PROTECTIVE EARTHING CONNECTION.</p> <p><b>WARNING:</b> TO REDUCE THE RISK OF ELECTRIC SHOCK, DO NOT REMOVE COVER (OR BACK) AS THERE ARE NO USER-SERVICABLE PARTS INSIDE. REFER SERVICING TO QUALIFIED PERSONNEL.</p>	 <p>The lightning flash with arrowhead symbol, within an equilateral triangle is intended to alert the user to the presence of uninsulated “dangerous voltage” within the product’s enclosure that may be sufficient magnitude to constitute a risk of electric shock to persons.</p>
	 <p>The exclamation point within an equilateral triangle is intended to alert the user to the presence of important operating and maintenance (servicing) instructions in the literature accompanying the appliance.</p>
	 <p>The asterisk within an equilateral triangle is intended to inform the user to necessary installation or removal instructions regarding equipment or hardware use relating to the system.</p>

1. Read and keep these safety instructions. Follow all instructions and heed all warnings.
2. Download the latest version of the applicable installation manual from [www.electrovoice.com](http://www.electrovoice.com) for installation instructions.



### Information

Refer to the Installation Manual for instructions.

3. Follow all installation instructions and observe the following alert signs:



### Notice!

Containing additional information. Usually, not observing a notice does not result in damage to the equipment or personal injuries.



### Caution!

The equipment or the property can be damaged, or persons can be injured if the alert is not observed.



### Danger!

Risk of electric shock.

4. **Clean only with dry cloth.** - Unplug the apparatus from the outlet before cleaning. Do not use liquid cleaners or aerosol cleaners.
5. **Condensation** - In order to avoid condensation; wait a few hours before turning on the equipment when it is transported from a cold to a warm space.
6. The apparatus shall not be exposed to dripping or splashing and no objects filled with liquids, such as vases, shall be placed on the apparatus.

**Danger!**

To reduce the risk of fire and electric shock, do not overexpose this apparatus to rain or moisture.

7. **Do not block any ventilation openings. Install in accordance with the manufacturer's instructions.** - Openings in the enclosure, if any, are provided for ventilation and to ensure reliable operation of the apparatus and to protect it from overheating. These openings must not be blocked or covered. This apparatus should not be placed in a built-in installation unless proper ventilation is provided or the manufacturer's instructions have been adhered to.
8. Do not install near any heat sources such as radiators, heat registers, stoves, or other apparatus (including amplifiers) that produce heat or in direct sunlight.
9. No naked flame sources, such as lighted candles, should be placed on the apparatus.
10. **Only use attachments/accessories specified by the manufacturer.** - Any mounting of the apparatus should follow the manufacturer's instructions, and should use a mounting accessory recommended by the manufacturer.
11. **Use only with the cart, stand, tripod, bracket or table specified by the manufacturer, or sold with the apparatus.** - When a cart is used, use caution when moving the cart/apparatus combination to avoid injury from tip-over. Quick stops, excessive force, and uneven surfaces may cause the appliance and cart combination to overturn.

**Caution!**

Tripod is not evaluated for safety with this loudspeaker. Check the specifications of the tripod stand to be certain it is capable of supporting the weight of the loudspeaker.

12. System installation and servicing by qualified personnel only, in accordance with applicable local codes. No user-serviceable parts inside.
13. Devices installed above 2 m height may cause injury when falling down. Preventive measures must be taken.
14. **Replacement parts** - When replacement parts are required, be sure the service technician has used replacement parts specified by the manufacturer or having the same characteristics as the original part. Unauthorized substitutions may result in fire, electric shock or other hazards.
15. **Safety check** - Upon completion of any service or repairs to this apparatus, ask the service technician to perform safety checks to determine that the apparatus is in proper operating condition.

**Precautions:**

- Do not use Electro-Voice loudspeakers in an environment where temperatures are below 0°C (32°F) or exceed +35°C (95°F).

- Electro-Voice loudspeakers are easily capable of generating sound pressure levels sufficient to cause permanent hearing damage to anyone within normal coverage distance. Caution should be taken to avoid prolonged exposure to sound pressure levels exceeding 90 dB. To prevent hearing damage do not listen at high volume levels for long periods.

### Suspension:

#### Warning!



Suspending any object is potentially dangerous and should only be attempted by individuals who have a thorough knowledge of the techniques and regulations of suspending objects overhead. Electro-Voice strongly recommends all loudspeakers be suspended taking into account all current national, federal, state, and local laws and regulations. It is the responsibility of the installer to ensure all loudspeakers are safely installed in accordance with all such requirements. When loudspeakers are suspended, Electro-Voice strongly recommends the system be inspected at least once per year or as laws and regulations require. If any sign of weakness or damage is detected, remedial action should be taken immediately. The user is responsible for making sure the wall, ceiling, or structure is capable of supporting all objects suspended overhead. Any hardware used to suspend a loudspeaker not associated with Electro-Voice is the responsibility of others.

#### Warning!



Do not suspend this product in any other manner than explicitly described in this manual, or Electro-Voice installation guides. Suspending any object (loudspeaker) is potentially dangerous and should only be done by individuals with thorough knowledge of techniques, materials, and regulations for suspending objects overhead. Electro-Voice loudspeakers can only be suspended using accessories and hardware described in Electro-Voice manuals and installation guides. **Do NOT use handles to suspend the loudspeaker. Handles on Electro-Voice loudspeakers are intended to only be used for temporary transport by people. Items, such as fiber rope, wire rope, cables, or other types of materials cannot be used to suspend loudspeaker from the handles.** Any hardware used to suspend a loudspeaker not associated with Electro-Voice is the responsibility of others.

#### Warning!



Use of non-authorized accessories or attachments with this or any Electro-Voice product is at your own discretion. Use of non-authorized accessories or attachments can result in product malfunction, injury, or death.

The user assumes all liability and may result in the warranty being voided.

### Old electrical and electronic equipment



This product and/or battery must be disposed of separately from household waste. Dispose such equipment according to local laws and regulations, to allow their reuse and/or recycling. This will help in conserving resources, and in protecting human health and the environment.

## 1.2 Battery and internal charger safety rules

### Battery and internal charger safety rules

1. Before using Electro-Voice internal battery charger to re-charge the battery, read all instructions and warning markings on (1) battery, (2) loudspeaker.
2. To reduce the risk of injury, charge only Electro-Voice battery packs specified for use with the loudspeaker. Other types of batteries may burst causing personal injury and damage.
3. Only charge the battery pack in temperatures above 0 °C (+32 °F) and below 35 °C (+95 °F). Avoid charging battery in direct sunlight. Store the loudspeaker and the battery pack in locations where temperatures will not exceed 45 °C (113 °F). This is important to prevent serious damage to the battery cells.
4. Unless otherwise specified by Electro-Voice with the use of approved accessories, do not recharge the battery in a damp or wet environment and do not expose the loudspeaker to rain or snow while plugged in to mains power. Water entering battery charger may result in electric shock or fire.



### Caution!

Always use the supplied weather cover and/or Electro-Voice approved rain cover accessory in wet environments.

5. Never submerge the battery pack, or the loudspeaker in fluid of any kind or allow fluid to enter them. Corrosive or conductive fluid (such as seawater or industrial chemical or bleach containing products, etc.) can cause short circuit, which may result in fire, personal injury and property damage.
6. Battery leakage may occur under extreme usage or temperature conditions. Avoid contact with skin and eyes. The battery liquid is caustic and could cause chemical burns to tissues. If liquid comes in contact with skin, wash quickly with soap and water. If the liquid contacts your eyes, flush them with water for a minimum of 10 minutes and seek medical attention.
7. Place the loudspeaker on flat nonflammable surfaces and away from flammable materials when using or charging the battery pack. Carpeting and other heat insulating surfaces block proper air circulation which may cause overheating of the charger and battery pack. If smoke or melting of the loudspeaker or battery pack is observed, unplug the loudspeaker immediately and do not use the battery pack or the loudspeaker. Contact customer service immediately.
8. Make sure cord is located so that it will not be stepped on, tripped over, or otherwise subjected to damage or stress. Damaged plug and cord may result in electric shock or fire.
9. Disconnect the loudspeaker by pulling the plug rather than the cord. Do not operate the loudspeaker with damaged cord or plug. Have them replaced immediately. Damaged plug or cord may result in electric shock or fire.
10. Do not insert the battery pack in the loudspeaker if the battery pack case is cracked or visibly damaged. Using a damaged battery pack may result in electric shock or fire.
11. Do not disassemble or operate the loudspeaker if it has received a sharp blow, been dropped or otherwise damaged in anyway. Incorrect reassembly or damage may result in electric shock or fire.

12. Before each use, check the loudspeaker, cable, plug and battery pack. Do not use if damage is detected. Never open the battery pack yourself, take it to an Electro-Voice Service Center, only using original replacement parts. Incorrect reassembly or using damaged product may result in electric shock or fire.
13. Only use accessories or batteries recommended or sold by Electro-Voice. Using attachments not recommended may result in electric shock or fire.
14. Unplug the loudspeaker from outlet before storage, attempting any maintenance or cleaning. Such preventive safety measures reduce the risk of electric shock or fire.
15. Replace battery pack if a substantial drop in operating time per charge is observed. Battery pack may be nearing the end of its life.

#### Battery care



#### Warning!

**When batteries are not installed in a loudspeaker, keep them away from metal objects.**

For example, to protect terminals from shorting **DO NOT** place batteries in a tool box or pocket with nails, screws, keys, etc. Fire or injury may result.

**DO NOT PUT BATTERIES INTO FIRE** or expose to high heat. They may explode.



#### Warning!

**Do not attempt to disassemble the battery or remove any component projecting from the battery terminals.** Fire or injury may result. Prior to disposal, protect exposed terminals with heavy insulating tape to prevent shorting.



#### Warning!

Do not use the loudspeaker in damp or wet environments without the proper installation of the included weather cover or Electro-Voice approved rain cover in accordance with the user manual.

Always ensure any device, cable, or instrument connected to the loudspeaker is also properly protected from moisture, properly grounded with ground fault circuit interrupt, and used in accordance with their respective manufacturer's directions.



#### Notice!

Electro-Voice battery packs

Use of battery packs not sold by Electro-Voice will void the warranty.



#### Notice!

Battery protection mode

The lithium-ion battery is protected against deep discharging by the "Battery protection mode". When the battery is empty, the loudspeaker enters a battery protection mode. The battery is supplied partially charged. Completely charge the battery before using your loudspeaker for the first time. The lithium-ion battery can be charged at any time, without reducing its service life. Interrupting the charging procedure does not damage the battery.



#### Notice!

Battery disposal

Do not dispose batteries in household waste. Dispose of batteries only at suitable collection points and, in the case of lithium batteries, cover the battery terminals with electrical tape or other electrically insulating material. The lithium-ion battery must be collected, recycled or disposed of in an environmentally sound manner.

**Warning!**

Air transport warning

Follow all applicable air transport cargo and passenger baggage regulations for lithium-ion batteries and powered devices.

---

**Warning!**

Risk of explosion or burns

This device includes a lithium-ion battery pack. To reduce the risk of fire or burns, do not attempt to open, disassemble, or service the battery pack. Do not crush, puncture, short external contacts, or dispose of in fire or water. Only use the device in temperatures between 0 °C (32 °F) and 35 °C (95 °F). Recycle or dispose of properly.

---

## 2 Description

Thank you for choosing an Electro-Voice powered loudspeaker system. Please take time to consult the manual to understand all the features built into your Electro-Voice system and fully utilize its performance capabilities.

EVERSE is a versatile, easy to use, compact, battery-powered loudspeaker system. It provides professional level performance and is housed in a robust weatherized enclosure. EVERSE loudspeakers provide real professional performance for musical performances, voice reinforcement and audio playback. EVERSE loudspeakers take advantage of decades of Electro-Voice and Dynacord pro-audio and electronics expertise, along with new advancements in technology, to provide truly portable and truly wireless audio.

The EVERSE 8 utilizes a 2-way configuration with an 8-inch woofer. It includes a high-output, titanium, ferro-fluid cooled tweeter, featuring a high-energy neodymium magnet for maximum output and reduced weight. The tweeter is mounted to an Electro-Voice patented SST constant directivity waveguide design, producing exceptionally high SPL with even 100° x 100° coverage and improved acoustic alignment and bass extension.

The EVERSE 12 utilizes a 2-way configuration with a 12-inch woofer and a high efficiency titanium compression driver mounted on Electro-Voice's patented SST baffle. It produces 5 dB higher SPL with 100° x 60° coverage and deeper bass than the EVERSE 8.

The rugged polypropylene enclosure features a weatherized input cover for the input section, allowing the loudspeaker to meet IP43 rating (splash and light rain resistant) for use on battery power and Bluetooth® streaming. The available accessory rain cover allows for additional weather resistance and protection when needed.

EVERSE loudspeakers feature Electro-Voice's QuickSmart DSP and are **POWERED BY DYNACORD**, featuring a built-in 4-channel digital mixer with FX, feedback suppression, and ducking features. The loudspeakers feature a custom designed, and fully optimized for audio use, high capacity battery pack. The battery pack provides more than enough power to complete the show, including a 12 V DC accessory port to power RE3 or R300 wireless microphone systems.

Both EVERSE 8 and EVERSE 12 are available in white and black.

### 2.1 Short information

The following table lists products in the EVERSE family, with CTN (Commercial Type Number) and identifying product name DESCRIPTION.

CTN	Description
EVERSE8-US	8" 2-way speaker battery black US
EVERSE8-EU	8" 2-way speaker battery black EU
EVERSE8-W	8" 2-way speaker battery white US&EU
EVERSE8-TRAY-B	Tray for EVERSE 8, 12V DC cable black
EVERSE8-TRAY-W	Tray for EVERSE 8, 12V DC cable white
EVERSE8-RAINCVR	Rain resistant cover for EVERSE 8
EVERSE8-TOTE	Padded tote bag for EVERSE 8
EVERSE-BAT-B	Battery pack assembly, EVERSE, black
EVERSE-BAT-W	Battery pack assembly, EVERSE, white

CTN	Description
EVERSE12-US	12" 2-way speaker battery black US
EVERSE12-EU	12" 2-way speaker battery black EU
EVERSE12-W	12" 2-way speaker battery white US&EU
EVERSE12-TRAY-B	Tray for EVERSE 12, 12V DC cable, black
EVERSE12-TRAY-W	Tray for EVERSE 12, 12V DC cable, white
EVERSE12-RAINCVR	Rain resistant cover for EVERSE 12
EVERSE-DUFFEL	Padded duffel bag for EVERSE

## 2.2

### System features

- **Long run-time removable and replaceable battery pack**  
The EVERSE battery pack will provide 6+ hours of constant music playback at maximum output levels, or 12+ hours at 95 dB SPL average (EVERSE 8) and 100 dB SPL average (EVERSE 12). EVERSE loudspeakers have integrated power saving features to extend battery life when no signal is present. The 12 V DC jack on the EVERSE loudspeakers can be used to power a wireless microphone receiver such as the Electro-Voice RE3 or R300.
- **Real professional level output and Electro-Voice sound quality**  
The EVERSE 8 features an 8-inch woofer with SST port and a 1-inch titanium dome tweeter which produces 121 dB SPL max, and has a frequency range from 50 Hz to 20 kHz. The EVERSE 12 features a 12-inch woofer with SST port and a 1-inch titanium compression driver which produces 126 dB SPL max, and has a frequency range from 45 Hz to 20 kHz. The EVERSE 8 has a waveguide formed coverage of 100° x 100° (H x V), and the EVERSE 12 has a waveguide formed coverage of 100° x 60° (H x V). Both EVERSE 8 and EVERSE 12 include two monitor angles (25° and 55°) that ensure the right coverage and position for any situation.
- **Easy to use with QuickSmart Mobile app and Electro-Voice's Intuitive User Interface**  
EVERSE loudspeakers feature Electro-Voice's intuitive QuickSmart DSP with single encoder and push key interface for simple and quick setup. EVERSE loudspeakers can be paired via Bluetooth® to a mobile device with the QuickSmart Mobile app installed to provide easy remote control of all audio functions. The QuickSmart Mobile app allows pairing and grouping of up to six loudspeakers, in any combination, including EVERSE , ELX200 powered family, and the EVOLVE family.
- **High Quality Stereo Bluetooth® streaming**  
EVERSE loudspeakers feature Bluetooth® streaming. Two EVERSE loudspeakers can be paired for true wireless stereo (TWS) streaming from a mobile device.
- **POWERED BY DYNACORD with built-in digital 4-channel mixer**  
EVERSE loudspeakers feature a built-in 4-channel mixer with FX, EQ, automatic feedback suppression and ducking functions. The mixer includes two XLR/TRS combo jacks, including 48V phantom power on **INPUT 1** (XLR) and Hi-Z compatibility on **INPUT 2** (TRS). The mixer also includes Stereo Bluetooth® and 3.5 mm connections.
- **Auto-Standby**  
EVERSE loudspeakers offer an adjustable automatic standby function. This extends the battery runtime in case the loudspeaker is not being used. The default is 15 minutes. The loudspeaker can be re-activated to full operation by pressing a button on the panel or with the app.



– **Robust and attractive industrial design**

Both models include an easy-to-carry handle with soft-touch rubber, and the EVERSE 12 adds a side handle for more portability. Although larger than the EVERSE 8, the EVERSE 12 is one of the lightest 12-inch speakers in its class and weighs under 14 kg (29.8 lb). Both EVERSE 8 and EVERSE 12 are water resistant to IP43 with the included weatherized input cover.

## 2.3

### Quick setup

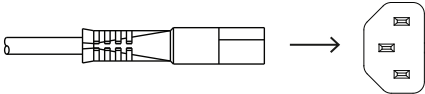
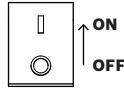
To set up the loudspeaker:

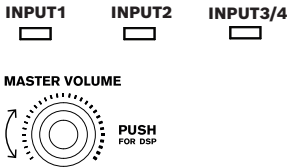
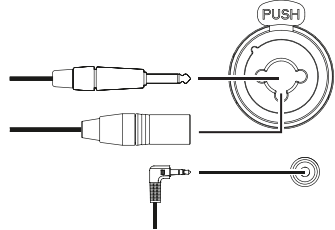
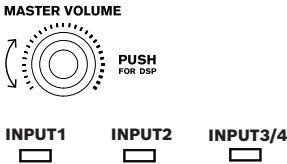
Step	Illustration
1. Connect the AC power cord from a grounded receptacle to the <b>MAINS IN</b> to ensure the battery has sufficient charge. <b>Note:</b> It is recommended to leave the loudspeaker plugged in and charging for 24 hours the first time it is used.	
2. Switch power to <b>ON</b> .	
3. Adjust the volume ( <b>VOL</b> ) to 0 dB using the <b>MASTER VOL</b> knob.	
4. Push the input selection soft key for <b>INPUT 1</b> or <b>INPUT 2</b> if using an XLR or ¼-inch (6.35 mm) cable, or push the input selection soft key for <b>INPUT 3/4</b> if using Bluetooth or 3.5 mm mini jack. Use the <b>MASTER VOL</b> knob to adjust <b>INPUT LEVEL</b> to <b>MUTE</b> .	
5. Connect an audio source using an XLR, TRS, or TS cable to <b>INPUT 1</b> , <b>INPUT 2</b> , or a 3.5 mm mini jack to <b>INPUT 3/4</b> . Ensure audio source is <b>MUTE</b> or at a low level before making connection. After connection is made, increase the source's output to a reasonable level.	
6. Adjust the <b>INPUT LEVEL</b> until the signal peaks are just below maximum level or the required output is achieved. If <b>PK</b> (PEAK) is indicated, turn the level down until the <b>PK</b> indication disappears. Press the input selection soft key again to exit the channel menu.	

7. Using the **MASTER VOL** knob, adjust the volume (**VOL**) until you get the required output from the loudspeaker.



### 3 Pairing the QuickSmart Mobile app

The EV QuickSmart Mobile app for tablets and smartphones is available for download from the Apple App Store and the Google Play Store.

Download and check the app for the latest firmware updates to enjoy optimal audio performance and maximize your control of the system.



#### Notice!

The EV QuickSmart Mobile app is designed to only find loudspeakers from Electro-Voice featuring Bluetooth® control functionality.

The EV QuickSmart Mobile app will not display other types of Bluetooth® devices, e.g. phones, laptops, tablets, or headsets.

Prior to pairing the EV QuickSmart Mobile app with Electro-Voice loudspeakers:

1. Ensure that Bluetooth® is enabled on the smartphone or tablet.
2. Ensure that pairing mode is enabled on the loudspeaker.

To place the loudspeaker in pairing mode for both control and streaming:

1. Press and hold **INPUT 3/4** until **Pairing Mode On** and the 4-digit ID is shown on the LCD.

Pairing mode can be enabled through the LCD menu for control and streaming separately.

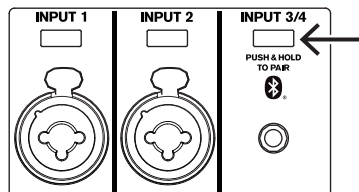

2. Navigate to your mobile device's Bluetooth® settings menu, find the EVERSE loudspeaker with the matching 4-digit ID and ensure you are paired to the loudspeaker. This will pair the mobile device to the EVERSE loudspeaker for audio streaming.
3. Continue to the next step to pair for control.



#### Notice!

For Android devices ensure location services are allowed. Electro-Voice does not collect, store, or track user location data or personal information.

#### First time pairing

1. Open the EV QuickSmart Mobile app. 
2. **Select your Speakers** is displayed on the screen.  
The EV QuickSmart Mobile app is looking for available Bluetooth® enabled Electro-Voice loudspeakers.  
The available loudspeakers are displayed on the screen.
3. Tap the loudspeaker you want to pair with the app.  
The selected loudspeaker will have a line under it acknowledging it is selected.

- Repeat the previous step until all of the required loudspeakers are selected.
- Tap the **CONNECT** button.

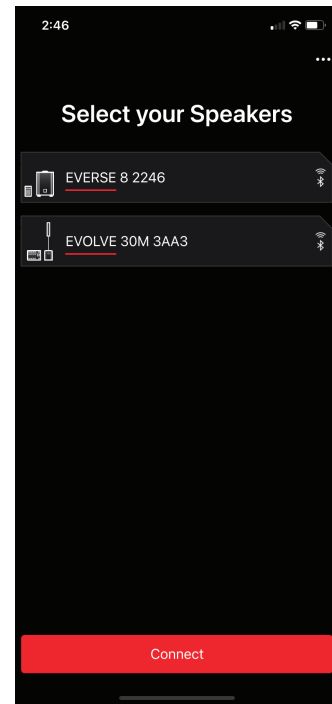
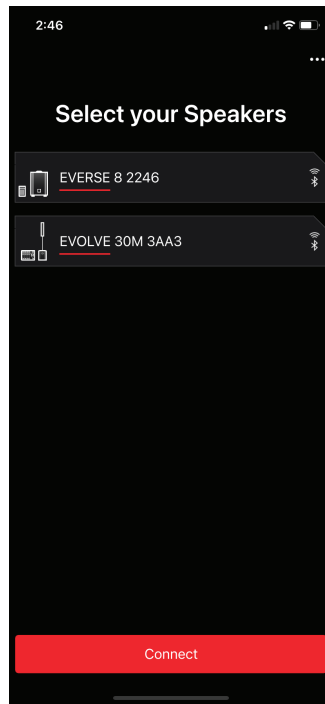

- The app connects with the selected loudspeaker. You will get a message from iOS/iPadOS/Android about pairing for each device which has to be accepted.
- Tap **PAIR** on the device to accept pairing to the loudspeakers. The app can connect to up to six loudspeakers.

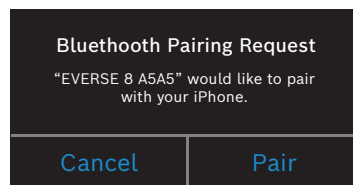

### Subsequent pairing

To pair additional loudspeakers with the EV QuickSmart Mobile app:

- Tap the EV QuickSmart Mobile app icon. 
- Select your Speakers** is displayed on the screen. The EV QuickSmart Mobile app is looking for available Bluetooth® enabled Electro-Voice loudspeakers. The available loudspeakers are displayed on the screen.
- Tap the loudspeaker you want to pair with the app. The selected loudspeaker will have a line under it acknowledging it is selected.
- Repeat the previous step until all of the required loudspeakers are selected.

5. Tap the **CONNECT** button.  
The app connects with the required loudspeaker.  
The app can connect to up to six loudspeakers.

## 4 Operation

### 4.1 Installation and charging of battery pack

EVERSE loudspeakers come pre-installed with a high capacity Li-Ion battery pack. Charge the battery for 24 hours before the first use to ensure maximum battery run time and life expectancy.

To charge the battery:

- ▶ Plug the **MAINS IN** while the battery is installed in the EVERSE loudspeaker.

After the first full charge, the expected battery charge times are as follows:

- 4 hours or less with no signal and the power switched off.
- 6 hours or less with the power switched on and audio playing at high output levels.

The LCD will display  while the battery is charging with the power switched off.

The LCD will display  when the battery has reached full charge.

---

#### Notice!

Battery self-discharge



All Li-Ion batteries experience self-discharge over extended periods (several months). If a battery sits for an extended period without being charged, the battery may fully discharge. It may take longer than normal to fully recharge. If this occurs, allow the battery to charge a full 24 hours again before using.

Inspect your loudspeaker and battery monthly and recharge the battery. This will help maintain the batteries run time and extend its useful life.

---

#### Notice!

Battery run time



Powering external devices via the DC power jack, USB connection, and/or phantom power will reduce battery run time, depending on the power required. Typical use cases may experience a reduction of 25 % to 50 % of total run time. User results may vary.

Other factors such as the output level, the source material, the ambient temperature, and the number of times that a battery has been discharged also affect run time of lithium-ion battery systems.

---

To remove and reinstall the battery for inspection or replacement:

1. Place the loudspeaker grille side down with the battery door facing you on a flat non-scratching surface such as a workbench with a rubber mat.
2. Fully loosen the two finger tab screws by turning them counter-clockwise.
3. Gently but firmly pull on the battery pack by the finger pull located on the back of the battery door.

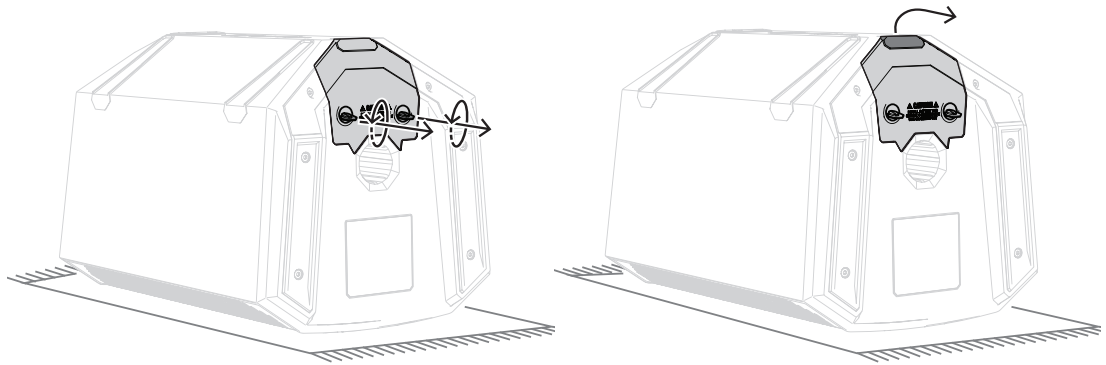

4. To reinstall the battery pack, follow the previous steps in reverse.

**Notice!**

Ensure that the battery door is fully seated before tightening the finger tab screws. Finger tighten only until snug. Do not over tighten or use excessive torque. This may cause damage.

## 4.2

### Weatherization

When the weatherized input cover is installed, the EVERSE loudspeaker is designed to be weather resistant to IP 43 standards, but not waterproof. The weather resistance may be reduced by damage, repair, improper disassembly, and regular wear and tear. Always inspect the EVERSE and accessories before and after every use. Allow the loudspeaker and components to dry before storage or between uses.

The EVERSE loudspeaker with weatherized input cover installed is intended only for temporary use in wet or damp environments. The loudspeaker is not intended to be exposed continuously to moisture over long periods of time. Do not expose to salt water or spray, do not expose to chlorine or use in high chlorine environments.

To use the loudspeaker in wet and damp environments safely:

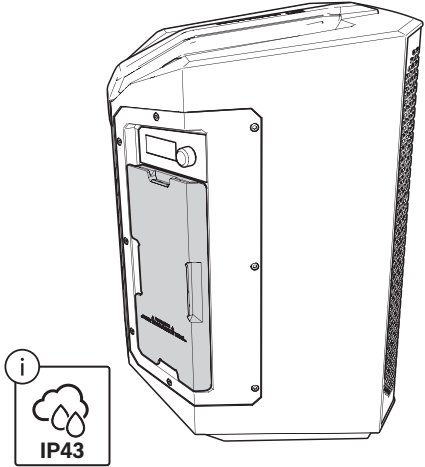
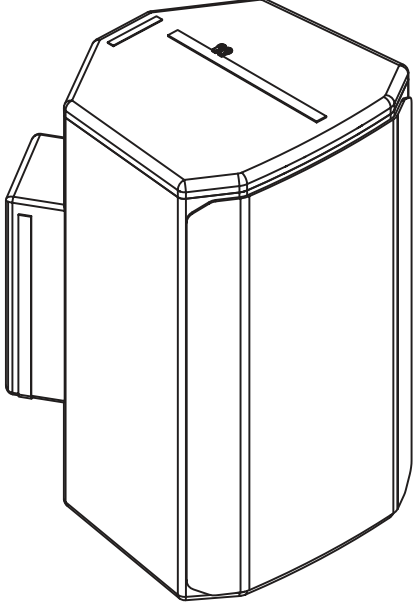
 <p>Use the weatherized input cover when on battery power and when using Bluetooth® streaming and control. Refer to <i>Installation of weatherized input cover</i>, page 22.</p>	 <p>Use the Electro-Voice approved accessory rain resistant cover when on mains power, or when any of the I/O connectors are needed. Refer to the accessory user guide for proper installation and use of rain resistant cover.</p>
---	--



**Warning!**

Only use EVERSE products in the manner explicitly called out in this section. Failure to do so may result in product failure or serious injury.





**Warning!**

Only use Electro-Voice approved accessories.

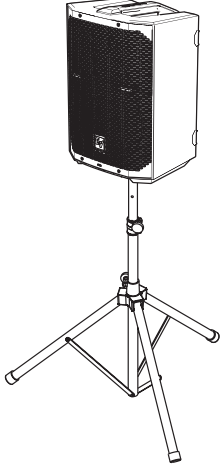
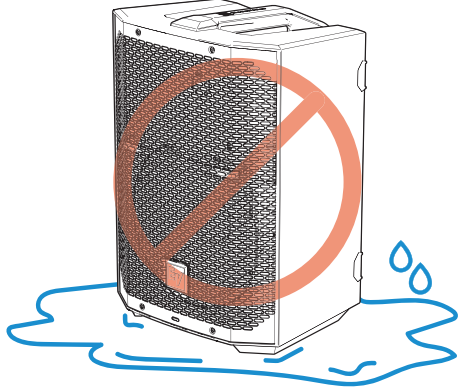
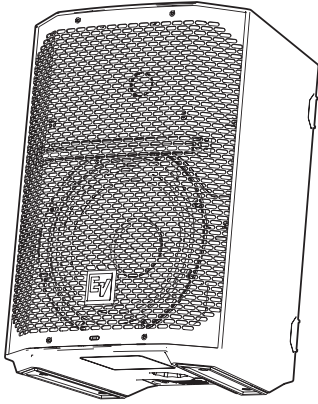
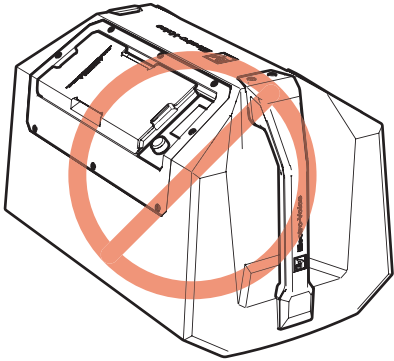
**Using the loudspeaker in damp or wet environments**

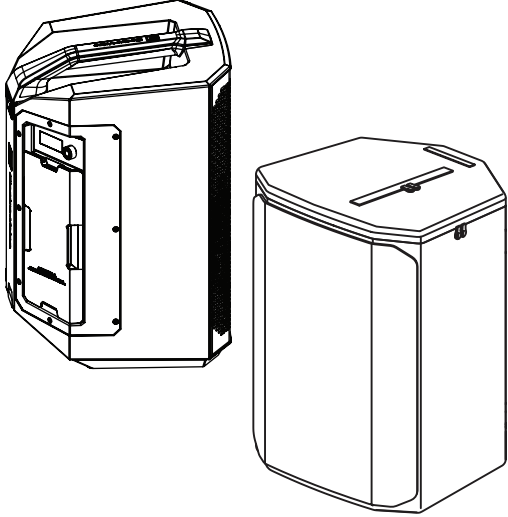
<b>Correct</b>	<b>Incorrect</b>
<p data-bbox="357 293 890 357">Place the loudspeaker on an elevated, level, stable surface, or on a tripod.</p> 	<p data-bbox="906 293 1426 357">DO NOT place the loudspeaker in a puddle or standing water.</p> 
<p data-bbox="357 900 855 1002">Always orient the loudspeaker upright, in the <b>KICKBACK</b> mode, or in the <b>MONITOR</b> mode.</p> 	<p data-bbox="906 900 1426 1002">DO NOT place or transport the loudspeaker upside down, or on the amp panel side to prevent water ingress.</p> 

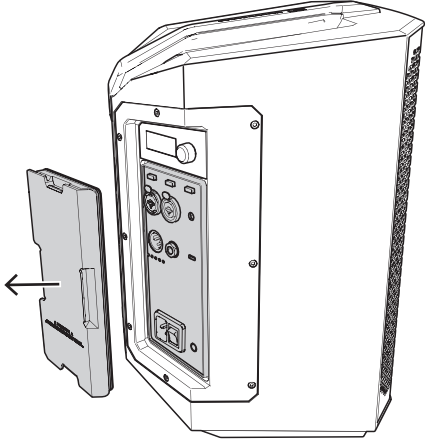
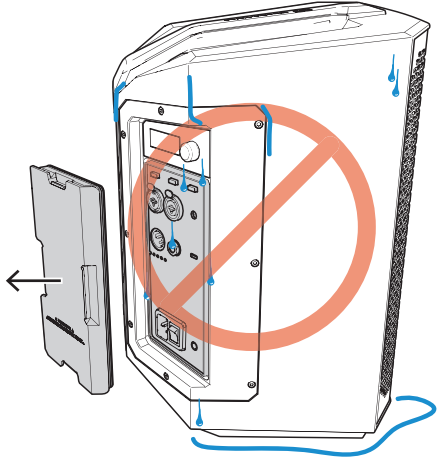
<b>Correct</b>	<b>Incorrect</b>
<p data-bbox="384 240 935 417">Always use the supplied weatherized input cover (refer to <i>Installation of weatherized input cover</i>, page 22) or the Electro-Voice approved accessory rain resistant cover in wet or damp environments.</p> 	<p data-bbox="935 240 1489 378">DO NOT use the EVERSE loudspeaker in damp or wet environments without the weatherized input cover or the accessory rain resistant cover.</p> 
<p data-bbox="384 985 935 1091">Dry the product and the weatherized input cover after use, prior to removing the weatherized input cover.</p> 	<p data-bbox="935 985 1489 1091">DO NOT remove the weatherized input cover while wet. If so, water may access the IO panel.</p> 

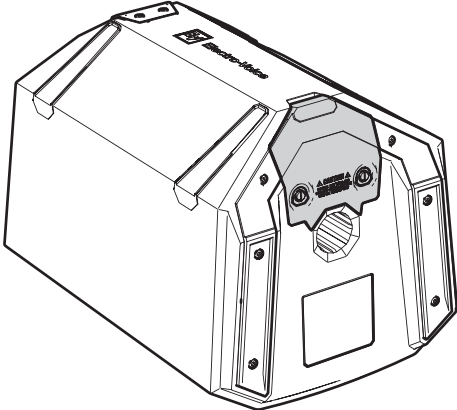
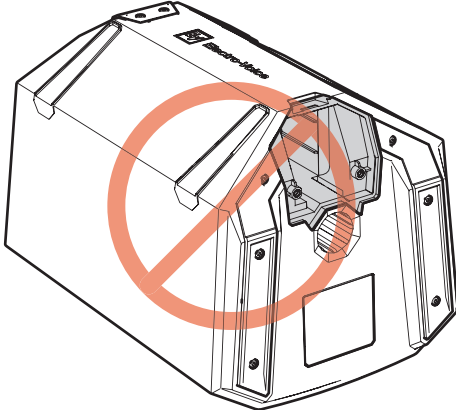
<b>Correct</b>	<b>Incorrect</b>
<p>Always ensure the battery is properly installed when operating in a wet or damp environment.</p> 	<p>DO NOT use in wet or damp environments when the battery is not installed. This may result in moisture entering the battery bay.</p> 

### 4.3

#### Installation of weatherized input cover

The weatherized input cover must be installed when the EVERSE loudspeaker is intended to be used in wet or damp conditions. When the weatherized input cover is installed, the EVERSE loudspeaker will be water resistant to IP43 standards. The EVERSE loudspeaker is able to operate under battery power and Bluetooth® streaming for audio, and control with the weatherized input cover installed.

##### To install the weatherized input cover:

1. Ensure that the weatherized input cover is fully intact, dry, clean and the gasket is in good condition.
2. Ensure that the input panel on the EVERSE loudspeaker is dry, clean, and the mating channel around the input connectors is dry and free of any dust or debris that would prevent a good seal.

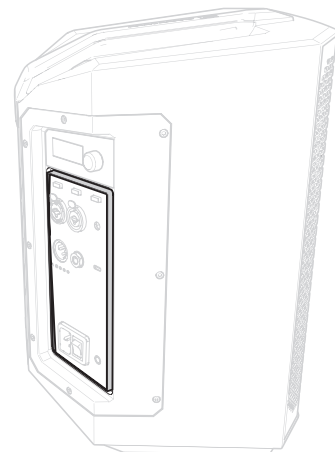
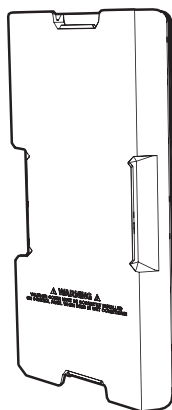

3. Power on the loudspeaker.

4. Install the weatherized input cover by pressing it firmly in order to fully seat the gasket in the mating channel on the amplifier input panel. The weatherized input cover will be flush with the adjacent panels of the loudspeaker.

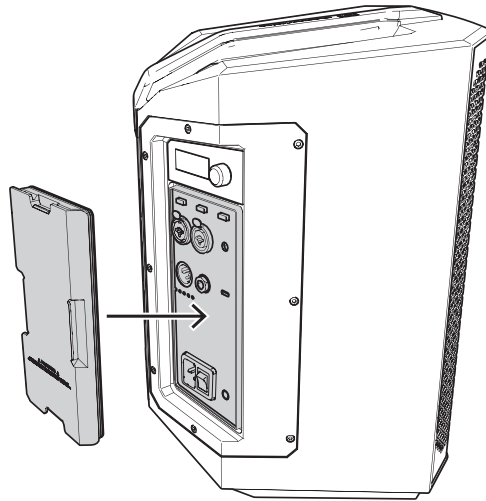

**To remove the weatherized input cover:**

- ▶ Pull the cover carefully and evenly using the finger pull-tabs.

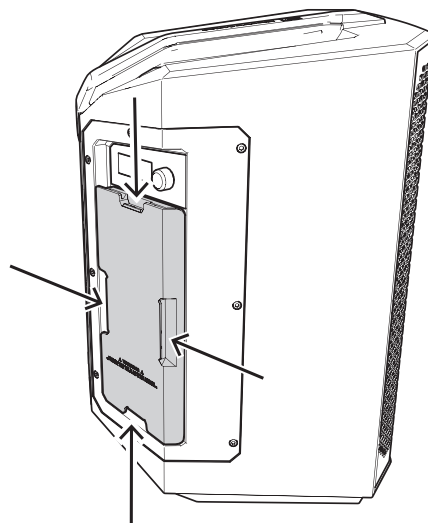

## 4.4 Tripod or pole mount

EVERSE loudspeakers mount on a tripod stand or on a pole above a subwoofer.

### Mounting a loudspeaker on a tripod stand



**Caution!**

Tripod is not evaluated for safety with this loudspeaker. Check the specifications of the tripod stand to be certain it is capable of supporting the weight of the loudspeaker.

To mount a loudspeaker on a tripod stand:

1. Place the tripod stand on a level and stable surface.

- Fully extend the legs on the tripod stand.
  - Do not compromise the tripod stand's structural integrity by trying to make the stand taller.
  - Do not attempt to mount more than one loudspeaker on a stand designed for a single loudspeaker.
2. Lift the loudspeaker using two hands.
  3. Set the pole cup located on the bottom of the loudspeaker onto the pole.
  4. Set the loudspeaker location to **TRIPOD** in the DSP control menu.

#### Mounting a loudspeaker on a pole

To mount a loudspeaker on a pole:

1. Place the subwoofer on a level and stable surface.
2. Insert the M20 threaded pole into the combo pole cup on the top of the subwoofer.
3. Turn the M20 threaded pole clockwise to secure the pole to the subwoofer.

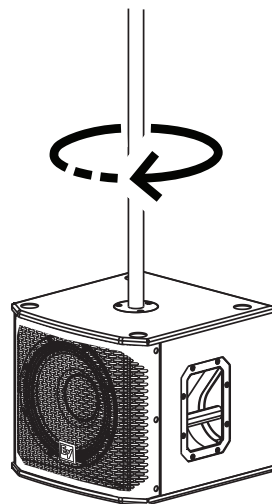

4. Lift the loudspeaker using two hands.
5. Set the loudspeaker location to **TRIPOD** in the DSP control menu.
6. Select the corresponding **SUB (X-OVER)** setting for your subwoofer.

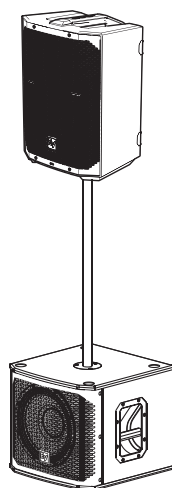



**Notice!**

Select **LOCATION TRIPOD** in menu or app for best sound.

## 4.5 Floor monitor & kickback

EVERSE loudspeakers may be used as a floor monitor or in kickback position by placing the loudspeaker on one of the two integrated monitor angles.

### Setting up a loudspeaker as a floor monitor

To set up a loudspeaker as a floor monitor:

1. Place the loudspeaker on a level and stable surface.
2. Safely route cables to prevent injury to performers, production crew, and audience members.
3. Set the loudspeaker location to **MONITOR** in the DSP control menu.

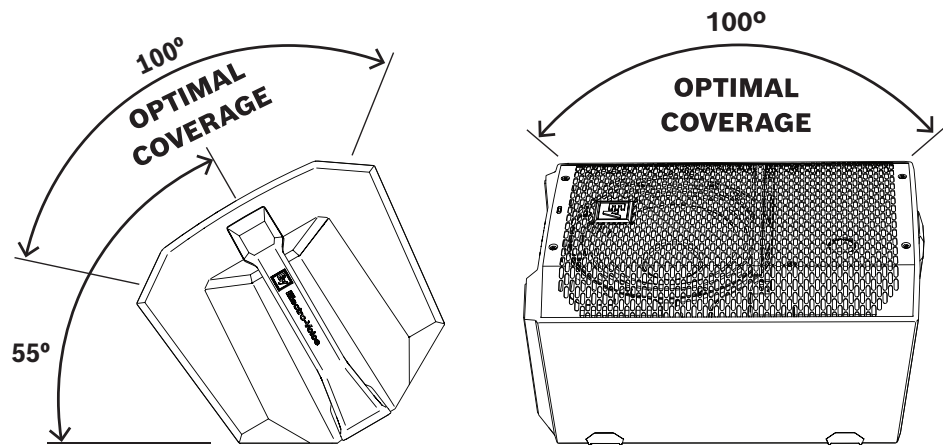

**Figure 4.1:** EVERSE 8 optimum coverage in monitor position (side view left and front view right)

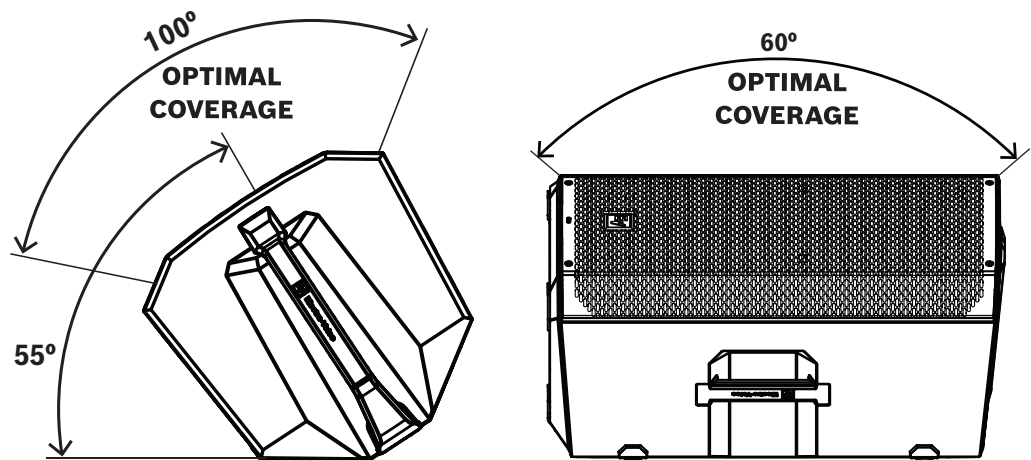
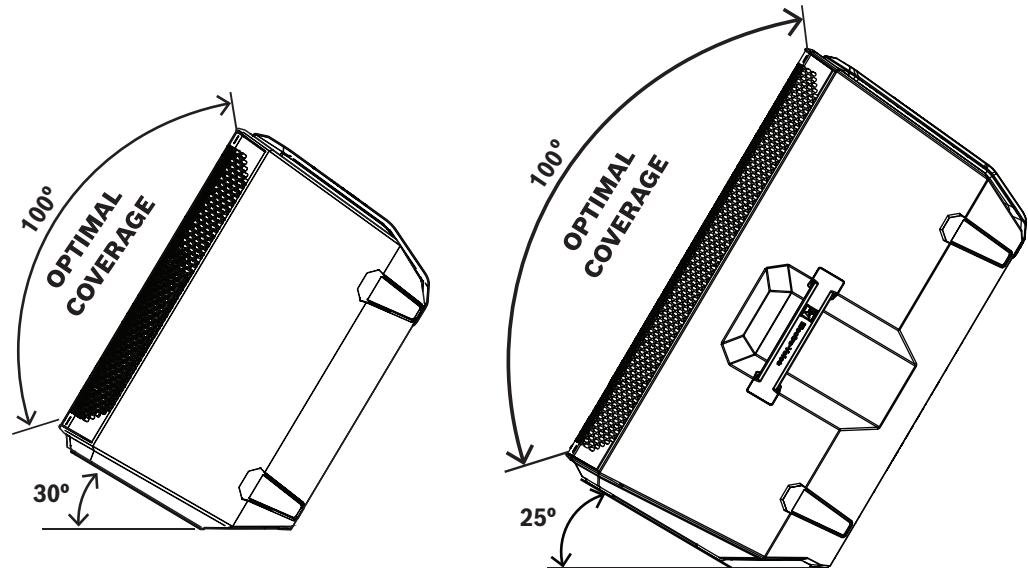

**Figure 4.2:** EVERSE 12 optimum coverage in monitor position (side view left and front view right)

### Setting up a loudspeaker in kickback position

To set up a loudspeaker in kickback position:

1. Place the loudspeaker on a level and stable surface.
2. Tilt the loudspeaker rearward to rest securely in the kickback position.
3. Safely route cables to prevent injury to performers, production crew, and audience members.
4. Set the loudspeaker location to **KICKBACK** in the DSP control menu.



**Figure 4.3:** EVERSE 8 and EVERSE 12 optimum coverage in kickback position

## 5 Amplifier DSP

### 5.1 Amplifier DSP controls

The amplifier has a combination of controls and connectors to ensure the most versatile loudspeaker system.

#### Loudspeaker control and monitoring interface

These DSP control menu selections are available for the EVERSE .

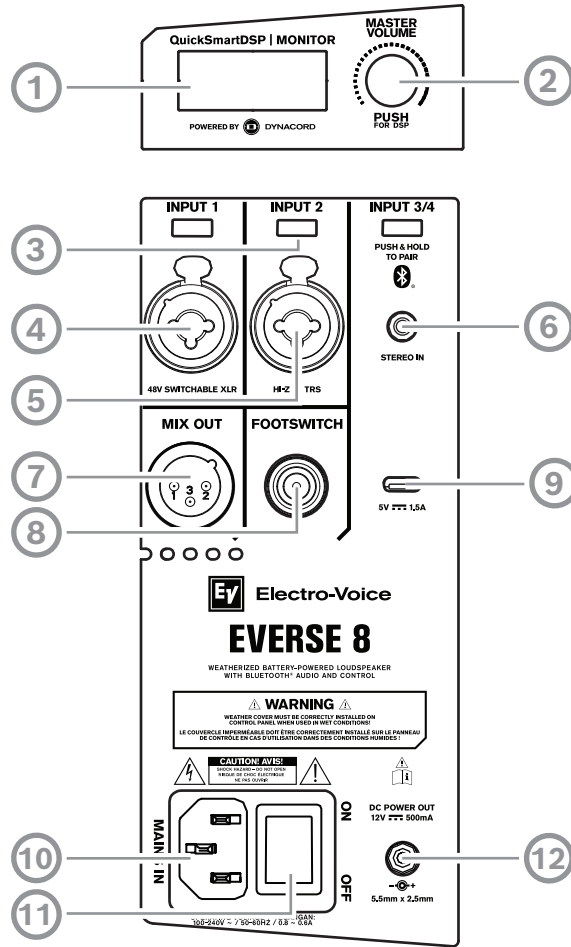

**Figure 5.1:** Loudspeaker amplifier panel

1. **LCD** – DSP control and monitoring interface.
2. **MASTER VOL** - Adjusts the sound level and navigates the DSP control menu.  
**DSP** - Scroll through the menu and select the available choices. Push the **MASTER VOL** knob to enter the DSP control menu.
3. **Input selection soft keys** - Press the soft key to select the input and access the DSP control menu for the channel. Press the softkey a second time to deselect the channel and return to the main DSP.
4. **INPUT 1** - Balanced INPUT for the connection of signal sources like mixing consoles, instruments, or microphones. Connections can be established using ¼-inch TRS or XLR connectors. The XLR connector is selectable for 48V phantom power.
5. **INPUT 2** - Balanced INPUT for the connection of input sources like mixing consoles, or microphones via XLR connector or Hi-Z instrument connection via TRS.

6. **INPUT 3/4** - Bluetooth® stereo INPUT for audio streaming or analog stereo INPUT via 3.5 mm mini-jack.
7. **MIX OUT** - XLR output sends either the mix of all input signals or the stereo L or stereo R signal to another loudspeaker or subwoofer.
8. **FOOTSWITCH** - ¼-inch TRS connector for connecting footswitch control to toggle FX on/off.
9. **Mobile device charging port** - 5 V 1.5 A charging for mobile devices.
10. **MAINS IN** – AC connection is established via an IEC-connector.
11. **POWER** - Switch for power **ON** or **OFF** of the loudspeaker. The LCD screen lights up when the power is turned **ON**, after approximately three seconds.
12. **DC POWER OUT** - DC power output jack for use with the 5.5 mm outer diameter and 2.5 mm inner diameter DC power cable included with the EVERSE-TRAY accessory. The DC POWER OUT jack is capable of powering a wireless microphone receiver which uses a center pin positive polarity and draws 500mA or less at 12 Volts DC, such as the Electro-Voice RE3 or R300 wireless microphone receiver.



### Warning!

The DC power jack is a power output. **THIS IS NOT A CHARGING PORT. DO NOT** connect a DC power adapter or attempt to re-charge the EVERSE loudspeaker's battery with this connector. Doing so may cause damage to the loudspeaker and void of warranty.

## 5.2

### System status

#### Normal

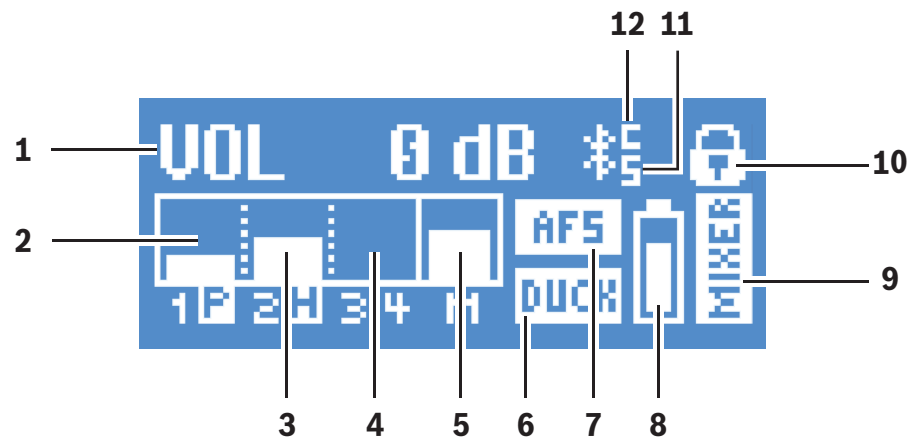

1. **VOL** - Indicates the master gain of the system in dB. The range is from -80 dB to +10 dB, in 1 dB increments.
2. **INPUT 1** - VU meter displays the signal level of INPUT 1 into the amplifier INPUT 1 connector. The display of **P** indicates 48V phantom power is switched on.
3. **INPUT 2** - VU meter displays the signal level of INPUT 2 into the amplifier INPUT 2 connector. The display of **H** indicates Hi-Z instrument connection is present on the INPUT 2 TRS connector.
4. **INPUT 3/4** - VU meter displays the signal level of INPUT 3/4 into the amplifier from either Bluetooth® streaming or 3.5 mm mini jack connection.
5. **MAIN** - VU meter displays the signal level of the MAIN output.
6. **DUCK** - Ducking is activated on either or both INPUT 1 and INPUT 2.
7. **AFS** - Automatic feedback suppression is enabled.

8. **BATTERY status** - Indicates the battery level of the loudspeaker and if the battery is charging (when **MAINS** is connected).
9. **FUNCTION indicator** - Indicates whether the system is in **MIXER** or **BASIC** mode.
10. **Status display** - Alternately shows the following:
  - 1** - Indicates the selected preset number. There are five user-defined presets available.
  - E** - Edited. Indicates the preset is not saved. When the preset is saved, the **E** is not displayed.
  - Lock status** - Indicates that the LCD display and controls are locked. Press the **MASTER VOL** knob or channel select soft key to unlock.
11. **S** - Bluetooth audio streaming. The available options are:
  - Off - disabled
  - Flashing - pairing mode (120s)
  - Solid - connected
12. **C** - Bluetooth control app. The available options are:
  - Off - disabled
  - Flashing - pairing mode
  - Solid - connected

**System protection**

System protection limiters indicate when a system is exceeding recommended usage by indicating input **CLIP** or output **LIMIT** on the LCD display.

**CLIP**

**CLIP** indicates that the signal to the loudspeaker is too high, resulting in a clipped signal into the loudspeaker.

If **CLIP** is shown:

- ▶ Reduce the **INPUT GAIN** and/or the signal on the mixer or source equipment.

**LIMIT**

**LIMIT** protects the loudspeaker from short-term peaks and long-term overload, which can cause distortion. When **LIMIT** is displayed on the screen, the limiter is active.

If the **LIMIT** indication is shown often or continuously:

- ▶ Reduce the output volume (**MASTER VOL**). This is strongly recommended.



**5.3**

**DSP controls**

An integrated DSP control menu allows the user to select multiple DSP system settings on the loudspeaker.

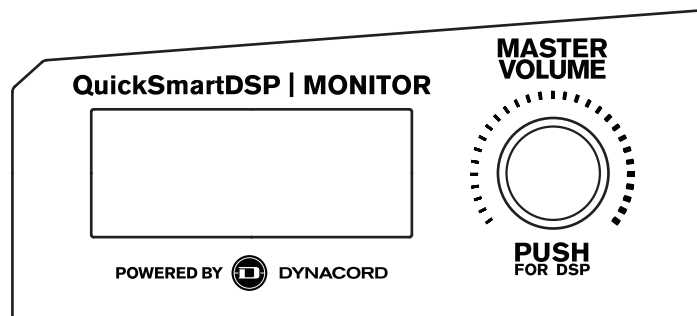

**Accessing the DSP control menu**

To access the DSP control menu:

1. Push the **MASTER VOL** knob.  
The DSP control menu appears.
2. Using the **MASTER VOL** knob, scroll through the menu items.
3. Push the **MASTER VOL** knob to select the menu item you want to modify.  
The focus moves to the parameters on the right side of the DSP control menu.
4. Using the **MASTER VOL** knob, scroll through the parameters.
5. Push the **MASTER VOL** knob to confirm the selected parameter.  
The setting is saved. The focus returns to the menu items on the left side of the DSP control menu.
6. Repeat steps 2 through 5 to modify additional DSP and system settings.
7. Select **EXIT** to return to the home screen.

### 5.3.1 Loudspeaker DSP control menu

The loudspeaker DSP control menu selections are available for the EVERSE loudspeakers.

#### DSP control menu for MIXER mode

VOLUME		0 dB (Default)
		MUTE, -80 dB - +10 dB (1 dB)
	EXIT	
	FUNCTION	MIXER (Default)
		BASIC
	MODE	MUSIC (Default)
		LIVE
		SPEECH
		CLUB
		FRFR-GUITAR
	MAIN LEVEL	0 dB (Default)
		MUTE, -80 dB - +10 dB (1 dB)
	LOCATION	TRIPOD (Default)
		KICKBACK
		MONITOR
	SUB (X-OVER)	OFF (Default)
		100 Hz
		120 Hz
150 Hz		
ELX200-12SP		

		ELX200-18SP
		EKX-15SP
		EKX-18SP
TREBLE		0 dB (Default)
		-12 dB - +6 dB
MID		0 dB (Default)
		-12 dB - +6 dB
BASS		0 dB (Default)
		-12 dB - +6 dB
MAIN EQ (PEQ settings)	BACK	
	ENABLE ALL	ON (Default)
		OFF
	PEQ #	1 (Default)
		1 - 7
	FILTER ENABLE	OFF (Default)
		ON
	TYPE	PEQ (Default)
		LOW SHELF
		HI SHELF
		LOW PASS
		HI PASS
	Q (PEQ only)	0.7 (Default)
		0.5 - 10.0
	FREQ	120 Hz (Default)
		50 - 20 kHz
	GAIN (PEQ, LOW SHELF and HI SHELF only)	0 dB (Default)
		-12 dB - +6 dB
	RESET	NO (Default)
		YES
RESET ALL	NO (Default)	
	YES	
MODE	PEQ	
	GEQ	
	BACK	

MAIN EQ (GEQ settings)	BACK	
	ENABLE ALL	ON
		OFF
	63 Hz	0 dB (Default) -12 dB - +12 dB (1 dB)
	160 Hz	0 dB (Default)
	400 Hz	-12 dB - +12 dB (1 dB)
	1 kHz	0 dB (Default)
	2.5 kHz	-12 dB - +12 dB (1 dB)
	6 kHz	0 dB (Default)
	12 kHz	-12 dB - +12 dB (1 dB)
	RESET ALL	NO
		YES
	MODE	PEQ
		GEQ
BACK		
FX	01 (Default)	
	00 to 30	
FX Delay (FX 20 only)	427 ms (Default)	
	30 ms - 550 ms	
FX ENABLE	ON (Default)	
	OFF	
AFS (automatic feedback suppression)	OFF (Default)	
	ON	
MIX OUT	L+R (Default)	
	L	
	R	
BLUETOOTH	BACK	
	BLUETOOTH	ON (Default)
		OFF
ID (4-digit unique device number)		

		CONTROL PAIR
		AUDIO PAIR
		LINK SPEAKERS
		BACK
LED		ON (Default)
		OFF
		LIMIT
DISPLAY	BACK	
	PIN LOCK	OFF
		TUNE
		ALL
	LOCK NOW (only if PIN is set)	
	DIM	ON (Default)
		OFF
	BRIGHT	5 (Default)
		1 - 10
	CONTRAST	5 (Default)
		1 - 10
	BACK	
STORE		BACK, 1, 2, 3, 4, 5, BACK
RECALL		BACK, 1, 2, 3, 4, 5, 6 (Default), BACK
STANDBY		15 min (Default)
		15 min - 60 min, OFF
RESET	DEFAULT SETTINGS?	NO (Default)
		YES
	ERASE USER PRESETS?	NO (Default)
		YES
INFO		[FIRMWARE VERSION]
		©2021 Electro-Voice
EXIT		

**Table 5.1:** Loudspeaker DSP control menu MIXER mode

**DSP control menu for BASIC mode**

VOLUME		0 dB (Default)
		MUTE, -80 dB - +10 dB (1 dB)
	EXIT	
	FUNCTION	MIXER (Default)
		BASIC
	MODE	MUSIC (Default)
		LIVE
		SPEECH
		CLUB
		FRFR-GUITAR
	LOCATION	TRIPOD (Default)
		KICKBACK
		MONITOR
	SUB	OFF (Default)
		100 Hz
		120 Hz
		150 Hz
		ELX200-12SP
		ELX200-18SP
		EKX-15SP
		EKX-18SP
	DELAY	OFF (Default)
		0.1 m - 100.0 m
	TREBLE	0 dB (Default)
		-12 dB - +6 dB
	MID	0 dB (Default)
		-12 dB - +6 dB
	BASS	0 dB (Default)
		-12 dB - +6 dB
MIX OUT	L+R (Default)	

		L
		R
BLUETOOTH	BACK	
	BLUETOOTH	ON (Default)
		OFF
	ID (4-digit unique device number)	
	CONTROL PAIR	
	AUDIO PAIR	
	LINK SPEAKERS	
	BACK	
LED	ON (Default)	
	OFF	
	LIMIT	
DISPLAY	BACK	
	PIN LOCK	OFF
		TUNE
		ALL
	LOCK NOW (only if PIN is set)	
	DIM	ON (Default)
		OFF
	BRIGHT	5 (Default)
		1 - 10
	CONTRAST	5 (Default)
1 - 10		
BACK		
STORE	BACK, 1, 2, 3, 4, 5, BACK	
RECALL	BACK, 1, 2, 3, 4, 5, 6 (Default), BACK	
STANDBY	15 min (Default)	
	15 min - 60 min, OFF	
RESET	DEFAULT SETTINGS?	NO (Default)
		YES
	ERASE USER PRESETS?	NO (Default)
		YES

	INFO	[FIRMWARE VERSION]
		©2021 Electro-Voice
	EXIT	

**Table 5.2:** Loudspeaker DSP control menu BASIC mode

### EXIT menu

The **EXIT** menu is used to return to the home screen.



### Notice!

The display returns to the home screen after 30 seconds of inactivity.

### FUNCTION menu

The **FUNCTION** menu is used to configure between **MIXER** and **BASIC** functions:

- **BASIC** - provides input and output gain controls, 3-band EQ, and system delay for simplified audio setups or used as satellite or R-channel stereo setup.
- **MIXER** - provides full access and control of the mixer.

### MODE menu

The **MODE** menu is used to configure the type of sound the loudspeaker delivers.

Available options for this selection are: **MUSIC**, **LIVE**, **SPEECH**, **CLUB**, and **FRFR-GUITAR**.

- **MUSIC** - is used for recorded music playback and electronic dance music applications.
- **LIVE** – is used for live sound applications.
- **SPEECH** – is used for spoken word applications.
- **CLUB** – is used for recorded electronic music playback.
- **FRFR-GUITAR** - Full Range Flat Response for use with guitar profiling hardware.

The default is **MUSIC**.

### LOCATION menu

The **LOCATION** menu is used to optimize the loudspeaker for different boundaries.

Available options for this selection are: **TRIPOD**, **KICKBACK**, **MONITOR**.

- **TRIPOD** - is used when the loudspeaker is placed on a tripod stand or placed on a pole.
- **KICKBACK** - is used when the loudspeaker is placed on the angled rear kickback position. This setting compensates for the amount of low frequency boost created by placing the loudspeaker on a level and stable flat surface.
- **MONITOR** - is used when the loudspeaker is placed on the angled monitor panel in monitor position. This setting compensates for the amount of low frequency boost created by placing the loudspeaker on a level and stable flat surface.

The default is **TRIPOD**.

### SUB menu

The **SUB** menu is used to select a high pass frequency for use with a subwoofer.

Available options for this selection are: **OFF**, **100 Hz**, **120 Hz**, **150 Hz**, **ELX200-12SP**,

**ELX200-18SP**, **EKX-15SP** and **EKX-18SP**. The **100 Hz**, **120 Hz**, and **150 Hz** choices are generic high pass settings for use with other subwoofers. The **ELX200-12SP**, **ELX200-18SP**, **EKX-15SP** and **EKX-18SP** settings are specifically optimized for subwoofers by including delay for best summation.

The default is **OFF**.

#### **TREBLE control**

The **TREBLE** control is used to adjust the high frequency performance of the loudspeaker for different applications or personal preference. The parameter controls a high shelving filter.

The default is **0 dB**.

#### **MID control**

The **MID** control is used to adjust the midrange frequency performance of the loudspeaker for different applications or personal preference.

The default is **0 dB**.

#### **BASS control**

The **BASS** control is used to adjust the low frequency performance of the loudspeaker for different applications or personal preference. The parameter controls a low shelving filter.

The default is **0 dB**.

#### **MAIN PEQ menu**

The **MAIN PEQ** is used to adjust the frequency response of the loudspeaker for different applications or personal preference. There are seven equalization filters available.

The filter type is selectable between the following:

**PEQ** - Parametric Equalization Filters shape the sound using peak/dip bell shaped filters which have three controls.

- **Q** - Quality Factor defines the bandwidth of the filter. A lower **Q** provides a wider bandwidth and a higher **Q** provides a narrower bandwidth.
- **FREQ** - selects the center frequency of the EQ filter.
- **GAIN** - sets the amount of increase or reduction of the equalization filter.

**LOW/HI SHELF** - Shapes the sound using a shelving type filter that can be applied to the low frequency or high frequency response using two controls:

- **FREQ** - sets the center frequency of the filter. For the **LOW SHELF** filter the **GAIN** of the filter tapers off above the frequency selected. For the **HIGH SHELF** filter the **GAIN** of the filter tapers off below the frequency selected.
- **GAIN** - sets the amount of increase or reduction of the signal below or above the **FREQ** setting.

**LOW/HI PASS** - Pass band filters that shape the sound by only passing signal above or below the selected frequency.

- **FREQ** - sets the corner frequency for the pass band filter. For **HI PASS** filters all frequencies above the selection will be passed through. Frequencies below the setting will be tapered off. For **LOW PASS** filters all frequencies below the selection will be passed through. Frequencies above the selection will be tapered off.

#### **MAIN GEQ menu**

The **MAIN GEQ menu** is used to adjust the frequency response of the loudspeaker for different applications or personal preference. There are seven different EQ filters available centered at the following frequencies: 63, 160, 400, 1.0K, 2.5K, 6.0K & 12K Hz. The filter is also independent of the **MAIN GEQ** setting if **AUX OUT** is set to **MAIN MIX**.

The range of each filter is -12 dB to +12 dB.

The default value for each filter is **0 dB**.

#### **FX & FX ENABLE**

The **FX** control is used to select the desired effect (e.g. reverb, chorus, delay, etc.) to apply to the FX send. The FX send level is independently controlled in the INPUT 1 and INPUT 2 FX control. The **FX ENABLE** turns **ON** or **OFF** the effect globally. **FX ENABLE** can be toggled with a footswitch.

### AFS (automatic feedback suppression)

The 12-band automatic feedback suppression (AFS) can be engaged to reduce unwanted feedback frequencies when microphones or instruments with pickups are used. Feedback occurs when sound from the loudspeaker enters the microphone or pickup and is amplified by the loudspeaker and played back again. High levels or extended periods of feedback can damage hearing and equipment.

Available options for this selection are **OFF** and **ON**.

### Reducing feedback

To reduce feedback:

1. Set the loudspeaker and microphone or instrument according to your performance. Follow appropriate microphone placement and use practices:
  - Do not place the microphone directly in front of the loudspeaker. Refer to the user manual of your microphone to know the pickup and rejection patterns of your microphone.
  - Avoid placing music stands, tablets, or other large flat objects near the microphone such that they can cause audio reflections into the microphone.
  - Use proper microphone technique when speaking, singing or playing by an instrument to avoid using excessive input gain. For example, hold the microphone close to your mouth when performing.
  - Engage appropriate input channel **PRESET** for your application: **LOW CUT 80 Hz**, **LOW CUT 120 Hz**, **VOCAL MIC**, **VOICE FILTER**, **SPEECH**, **ACOUSTIC GUITAR**, etc. Refer to *INPUT DSP control menu*, page 43.
  - Do not cup the microphone element with your hands while speaking or singing. Only hold the microphone by the handle or body as per the microphone manufacturer's recommendation.
2. Enable automatic feedback suppression (AFS) in the DSP control menu or FX section of the QuickSmart Mobile app. This will enable **AFS** on **INPUT 1** and **INPUT 2**.
  1. Slowly turn up the output of the loudspeaker, and begin sound checking your microphone or instrument.
  2. As you hear feedback, allow a few seconds for the automatic feedback suppression (AFS) to detect and to reduce the feedback.
  3. Continue sound check until no additional feedback tones are generated.

### MIX OUT menu

The **MIX OUT** menu is used to select which signal(s) should be output at **MIX OUT** and which signal should be delivered by the loudspeaker.

- **L+R** - The left and right signals of all inputs are summed. The sum is output at **MIX OUT** and is delivered by the loudspeaker (default).
- **L** - Only the panned left signal of all inputs is output at **MIX OUT**. The loudspeaker will deliver only the right signal.
- **R** - Only the panned right signal of all inputs is output at **MIX OUT**. The loudspeaker will deliver only the left signal.

### BLUETOOTH menu

The **BLUETOOTH** menu is used to set the Bluetooth® functionality of the loudspeaker.

**ON/OFF** - The **ON/OFF** menu controls whether Bluetooth® functionality is enabled or disabled on the loudspeaker.

**CONTROL PAIR** - The **CONTROL PAIR** menu is used to enable the QuickSmart Mobile app wireless control and monitoring application. Available options for this selection are: **ON** or **OFF**.

The default is **OFF**.

**AUDIO PAIR** - The **AUDIO PAIR** menu is used to stream audio from your Bluetooth® enabled device to the loudspeaker system. Available options for this selection are: **PAIRING**, **ON** or **OFF**.

The default is **OFF**.

### **LINK SPEAKERS**

The **LINK SPEAKERS** function allows two EVERSE loudspeakers to be linked over Bluetooth® in true wireless stereo.

To link two EVERSE loudspeakers:

1. Pair one of the EVERSE loudspeakers via Bluetooth® to a mobile device. Refer to *Pairing the QuickSmart Mobile app, page 14* for pairing instructions.
2. In both EVERSE loudspeakers, navigate to the **BLUETOOTH** menu in the Main DSP menu.
3. In both EVERSE loudspeakers, select **LINK SPEAKERS**.  
The LCD display will show **LINKING SPEAKERS...** while establishing connection between both EVERSE loudspeakers. When the connection is established, the menu will display **UNLINK SPEAKERS**.  
In the **BLUETOOTH** menu below the **LINKING SPEAKERS**, the stereo channel selection will appear.
4. Select the appropriate stereo channel selection for each EVERSE loudspeaker: **L+R** (mono), **L**, or **R**.

**Note:** This is stereo image from the audience's perspective, also known as House L & R.

### **LED menu**

The **LED** shows power on and indicates limit. Available options for this selection are: **ON**, **OFF** or **LIMIT**.

- **ON** - turns the LED on when the power switch is set to ON and system is not in standby mode.
- **OFF** - turns the LED off.
- **LIMIT** - turns the LED off under normal operation. The LED brief blinking indicates the limiter is activating. Short-term blinking is not critical because the integrated limiter keeps distortion under control. Constant lighting of the LED indicates the sound is negatively affected. If the LED is constantly lit, check the rear LCD for more information. Reducing the output volume is strongly recommended.

The default is **ON**.

### **PIN LOCK menu**

The **PIN LOCK** menu locks the DSP control menu. Available options for this selection are: **OFF**, **TUNE** or **ALL**.

- **OFF** - turns the **PIN LOCK** off.
- **TUNE** - locks the INPUT control parameters but not the DSP control menu.
- **ALL** - locks all functions of the speaker.

The default is **OFF**.

To lock the DSP control menu:

1. Select **TUNE** or **ALL**.
2. Enter a PIN code.
3. Re-enter the PIN code to confirm.  
If the PIN code does not match, it will set the **PIN LOCK** to **OFF**.
4. To lock the speaker select **LOCK NOW** from the **DISPLAY** menu.

The **PIN LOCK** will automatically engage after the speaker is power cycled.

To disable the **PIN LOCK**:

1. Deselect any input selection soft keys.
2. Push the **MASTER VOLUME** knob.
3. Using the **MASTER VOLUME** knob, scroll to **DISPLAY**.
4. Select **PIN LOCK**.
5. Select **OFF**.

If you forget the PIN code, reset the loudspeaker to default settings.

To reset the loudspeaker to default settings:

- ▶ Press and hold the soft key for **INPUT 2** and **MASTER VOLUME** knob for at least 10 seconds.  
The **DEFAULT SETTINGS?** message appears.
- ▶ Select **YES**.  
The **ERASE USER PRESETS?** message appears.
- ▶ Select **NO**.

#### **DIM menu**

The **DIM** menu is used to dim the display when the display is idle for 30 seconds. Available options for this selection are: **ON** or **OFF**.

The default is **ON**.

#### **BRIGHT menu**

The **BRIGHT** menu is used to determine the brightness of the LCD.

The range is 1 (darkest) to 10 (brightest).

The default is **5**.

#### **CONTRAST menu**

The **CONTRAST** menu is used to increase or decrease the visibility of the LCD screen based on lighting conditions.

The range is 1 (less contrast) to 10 (more contrast).

The default is **5**.

#### **STORE menu**

The **STORE** menu allows you to create up to five customized user settings. Available options for this selection are: **BACK**, **1**, **2**, **3**, **4**, and **5**.



#### **Notice!**

The customized user setting name can contain a combination of alphanumeric characters including spaces. The alphanumeric character range is A to Z and 0 - 9.

The name field length is 12 characters.

#### **Storing customized user settings**

To store customized user settings:

1. From the DSP control menu, scroll to **STORE**.
2. Push the **MASTER VOL** knob to select **STORE**.  
The **STORE** screen appears.
3. Push the **MASTER VOL** knob to select **1**.  
The **Enter name for 1** screen appears.
4. Use the **MASTER VOL** knob to scroll through the characters.  
The characters appear.
5. Push the **MASTER VOL** knob to select the required character.
6. Turn the **MASTER VOL** knob to move to the next character entry.

Continue selecting characters until the required name is entered.

7. Use the **MASTER VOL** knob to scroll to **SAVE**.
8. Push the **MASTER VOL** knob to select **SAVE**.
9. Repeat steps 3 through 8 to store additional customized user settings.
10. Select **EXIT** to return to the home screen.

### RECALL menu

The **RECALL** menu allows you to retrieve up to five customized user settings. Available options for this selection are: **BACK**, **1**, **2**, **3**, **4**, and **5**. In addition, setting **6** is available to recall a default setting. This setting cannot be used to store user settings.

### Recalling customized user settings

To recall customized user settings:

1. From the DSP control menu, scroll to **RECALL**.
2. Push the **MASTER VOL** knob to select **RECALL**.  
The **RECALL** screen appears.
3. Push the **MASTER VOL** knob to select **1**.  
The selected item is loaded.
4. After the preset is loaded, the menu will return to the home screen.

### STANDBY menu

To extend battery life, the EVERSE loudspeaker will enter **STANDBY** mode after a set amount of time. The **STANDBY** menu allows you to set the idle time (time with no audio or control signal present) before the loudspeaker enters **STANDBY** mode.

To return to normal operation mode:

- ▶ Apply a Bluetooth® audio signal or BLE control signal via the QuickSmart Mobile app.
- Or
- ▶ Press any button on the loudspeaker.



### Notice!

Analog input signals will not return the speaker to normal operation from **STANDBY** mode.

### RESET menu

The **RESET** menu is used to reset the loudspeaker to original factory settings. Available options for this selection are: **NO** or **YES**.

### Resetting the system

To reset the system to original factory settings:

- ▶ From the DSP control menu, select **RESET**.  
The **DEFAULT SETTINGS?** message appears.
- ▶ Select **YES**.  
The **ERASE USER PRESETS?** message appears.
- ▶ Select **YES**.



### Notice!

The **RESET** menu item is used to revert the loudspeaker to the original factory default settings.

### INFO menu

The **INFO** menu is used to display the firmware version.

**Refer to**

- *Effects (FX) list, page 59*

## 6 Input & Mixer operation

### 6.1 INPUT DSP control menu

The loudspeaker INPUT DSP control menu selections are available for the EVERSE loudspeakers.

To control the mixer channels:

1. Press the input selection soft key to select the input channel.  
The softkey will illuminate once selected.
2. Use the **MASTER VOL** knob to adjust the level.
3. Press the **MASTER VOL** knob to enter the input channel's DSP control menu.
4. Press the input selection soft key again to deselect the input channel for control.  
The soft key will no longer be illuminated.

#### INPUT DSP control menu for MIXER mode

INPUTS 1 & 2		
LEVEL		0 dB (Default)
		MUTE, -80 dB - +42 dB
	EXIT	
	48V (INPUT 1 only)	OFF (Default)
		ON
	PRESET	FLAT (Default)
		LOW CUT 80
		LOW CUT 120
		VOCAL MIC
		VOICE FILTER
		ND76 VOCAL
		RE520
		ND86 VOCAL
		ND86 VOCAL
		SPEECH
		ACOUST GUITAR
		ND66 A-GTR
		ELECTRIC GUITAR
		BASS GUITAR
	PERCUSSION	
	LINE INPUT	
	COMP	OFF (Default)
OFF, 1 - 100		

	TREBLE	0 dB (Default)
		-12 dB - +12 dB
	MID	0 dB (Default)
		-12 dB - +12 dB
	BASS	0 dB (Default)
		-12 dB - +12 dB
	FX	0 dB (Default)
		-80 dB - +10 dB
	PAN	C (Default)
		10 L - 10 R
	DUCKER	OFF (Default)
		OFF, -1 - -40
	EXIT	

**Table 6.1:** INPUTS 1 & 2 DSP control menu MIXER mode

INPUT 3/4			
LEVEL	0 dB (Default)		
	MUTE, -80 dB - +42 dB		
	EXIT		
	TREBLE	0 dB (Default)	
		-12 dB - +12 dB	
	MID	0 dB (Default)	
		-12 dB - +12 dB	
	BASS	0 dB (Default)	
		-12 dB - +12 dB	
	BAL (stereo operation only)	C (Default)	
		10 L - 10 R	
	BLUETOOTH	BACK	
		BLUETOOTH	ON (Default)
			OFF
		ID (4-digit unique device number)	
	CONTROL PAIR		

		AUDIO PAIR
		LINK SPEAKERS
		BACK
	EXIT	

**Table 6.2:** INPUT 3/4 DSP control menu MIXER mode

**INPUT DSP control menu for BASIC mode**

- 1) Default
- 2) INPUT 1 only

INPUTS 1 & 2		
LEVEL	MUTE -80 dB 0 dB <sup>1</sup> +42 dB	
INPUT 1	EXIT	
	48V <sup>2</sup>	OFF <sup>1</sup>
		ON
	EXIT	

- 1) Default
- 2) 4-digit unique device number

INPUT 3/4		
LEVEL	MUTE -80 dB 0 dB <sup>1</sup> +42 dB	
	BACK	
	BLUETOOTH	OFF
		ON <sup>1</sup>
		BACK ID <sup>2</sup> CONTROL PAIR AUDIO PAIR LINK SPEAKERS BACK
	BACK	

**Adjusting the incoming sound**

Caution is advised when adjusting the incoming sound. Usually minor changes are sufficient to produce the best results in the overall sound.

To adjust the incoming sound:

- Set all EQ controls to **0 dB** or **FLAT**.
- Avoid setting the EQ controls to extreme positions.

- Use natural reproduction as a starting point.
- Rely on your musically trained ear.

#### **INPUT LEVEL control**

The **INPUT LEVEL** control adjusts the sensitivity of the incoming signals to the internal operation level of the mixer.

To achieve a good signal input level:

1. Set the volume (**VOL**) to **MUTE** using the **MASTER VOL** knob.
2. Press the input selection soft key and use the **MASTER VOL** knob to set the **INPUT LEVEL** to **MUTE**.
3. Connect the sound source (microphone, instrument, etc) to the selected input.
4. Start the sound source at the highest volume level to be expected. Sing or speak as loudly as possible directly (close up) into the microphone.
5. While playing the sound source or singing into the microphone:
  - Increase the **INPUT LEVEL** by selecting the input channel using the input selection soft key and using the **MASTER VOLUME** knob, so that during the loudest part, the **CLIP** does not show. Press the input selection soft key again to deselect the input channel.
  - Increase the **MASTER VOLUME** until you get the required output from the loudspeaker. This is the basic channel setting.

If further adjustments to the EQ setting of the channel are necessary, perform these steps again. Changes in the sound shaping section also have an influence on the overall level of the channel.

#### **48V (INPUT 1 only)**

+48V DC phantom power is available on the XLR connector of **INPUT 1** only. Phantom power can be used to power certain devices such as DI boxes and condenser microphones (non-electret). Consult the user manual of your device before using. There is no phantom power on the TRS connectors. Phantom power is switchable.



#### **Notice!**

Switch off phantom power (default) for sources which do not require phantom power such as dynamic microphones and mixer outputs.



#### **Notice!**

Never connect a mobile device to **INPUT 1** with phantom power activated.

---

#### **PRESET**

The input **PRESET** adjusts the EQ and compressor settings to provide a starting point for adjusting the sound for different input types.

#### **COMP control**

The **COMP** control controls the onboard compressor to adjust the input signal processing during operation. Compressors are available on **INPUT 1** and **INPUT 2**.

- ▶ Use the **COMP** control to adjust the compressor threshold and the compression ratio simultaneously.

Adjusting the **COMP control** from 0 to 100 will result in the following:

- The gain below the threshold will increase from 0 dB to +6 dB.
- The compression ratio will increase from 1:1 to 8:1.

- The compressor will reduce the dynamic range of the audio signal proportional to the compressor setting.

Once the signal exceeds a certain threshold, the signal gets compressed. Major input level changes result in minor output level changes. Narrowing the dynamic range often allows for easier recording or mixing of the audio signal. It is recommended to start with low to moderate levels of compression (25 - 40) and increase slowly if necessary.

**TREBLE/MID/BASS controls**

The EQ section of the input channel allows for a broad difference in the shaping of the incoming audio signal within three frequency bands:

- **TREBLE** control - provides cymbals and vocals with more treble for a more transparent sound.
- **MID** control - provides higher output and reduces acoustical feedback by lowering the level.
- **BASS** control - adds more “punch” to the sound of a kick drum or adds “body” to the vocals.

**FX**

The **FX** control is used to set the amount of effect you require on that channel. Using the **FX** controls lets you easily assign an effect for musical instruments or vocals.

To determine the required level of effect:

1. Set the controls to minimum.
2. Increase the level individually and gradually until the required sound is achieved.

**PAN/BAL**

The **PAN** (mono inputs) or **BAL** (stereo inputs) control adjusts the amount of the signal coming out of the stereo L or stereo R loudspeaker in a stereo setup. The **PAN/BAL** is not engaged for mono (single loudspeaker) setups.

**DUCKER**

The **DUCKER** reduces the level of the signal(s) on the other inputs whenever a signal is detected at the selected MIC/LINE input (**INPUT 1** or **INPUT 2**). If no signal is detected at the selected MIC/LINE input, the level of the signal(s) on the other inputs will return to the previous set levels.

The **DUCKER** is useful to speak over background music:

- When signal is detected on the selected MIC input, the music on the other input channel will be reduced.
- When signal is no longer detected on the selected MIC input, the music will return to the previous level.

**Engaging the DUCKER**

To engage the ducker:

1. Select **INPUT 1** and/or **INPUT 2**.
2. Adjust the **DUCKER** level to set the detection threshold for the selected input channel. When signal is detected on the selected input, the signal on the other inputs will be reduced by 12 dB. Typical values are -10 to -20 dB.

The table below describes the **DUCKER** operation logic. The **DUCKER** setting is the detection threshold selected on **INPUT 1** and/or **INPUT 2**. The ducked channels are the input signals that are reduced by 12 dB.

	<b>INPUT 1</b>	<b>INPUT 2</b>	<b>Reduced channels</b>
DUCKER SETTING	-1 dB - -40 dB	OFF	INPUTS 2 & 3/4
	OFF	-1 dB - -40 dB	INPUTS 1 & 3/4

	<b>INPUT 1</b>	<b>INPUT 2</b>	<b>Reduced channels</b>
	-1 dB - -40 dB	-1 dB - -40 dB	INPUT 3/4
	OFF	OFF	NONE

# 7 Recommended configurations

## 7.1 Connecting with mobile device

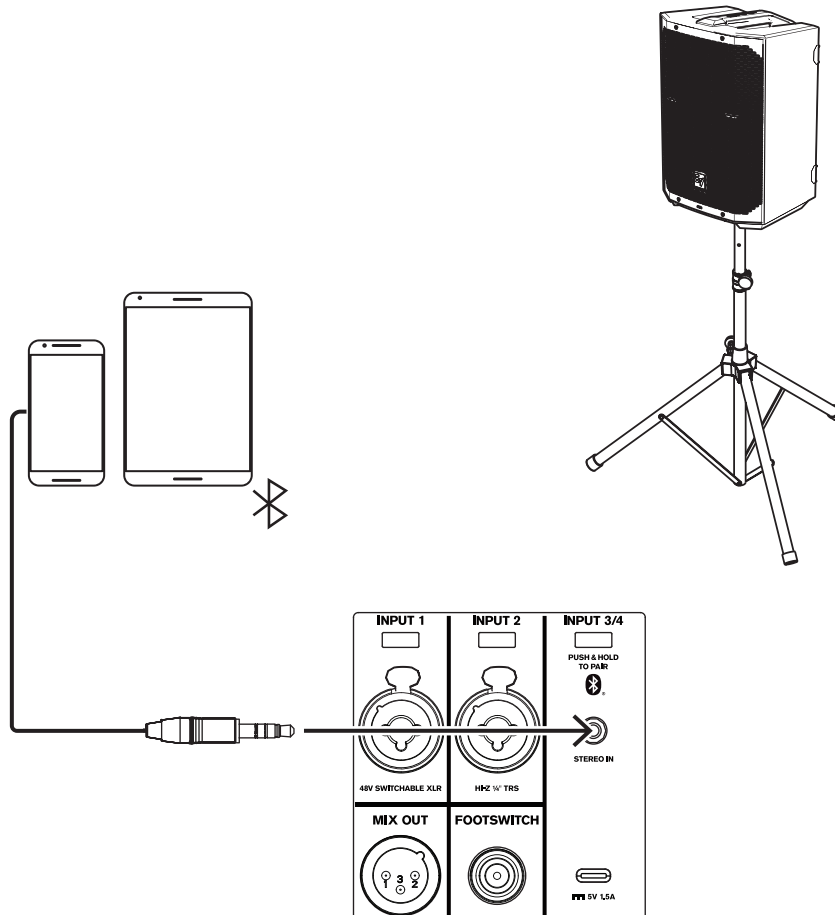

**Notice!**

The direction of the arrow indicates the signal path.

MODE	MUSIC
LOCATION	TRIPOD
SUB	OFF

**Table 7.1:** DSP settings loudspeaker on a tripod

## 7.2 Street musician performance

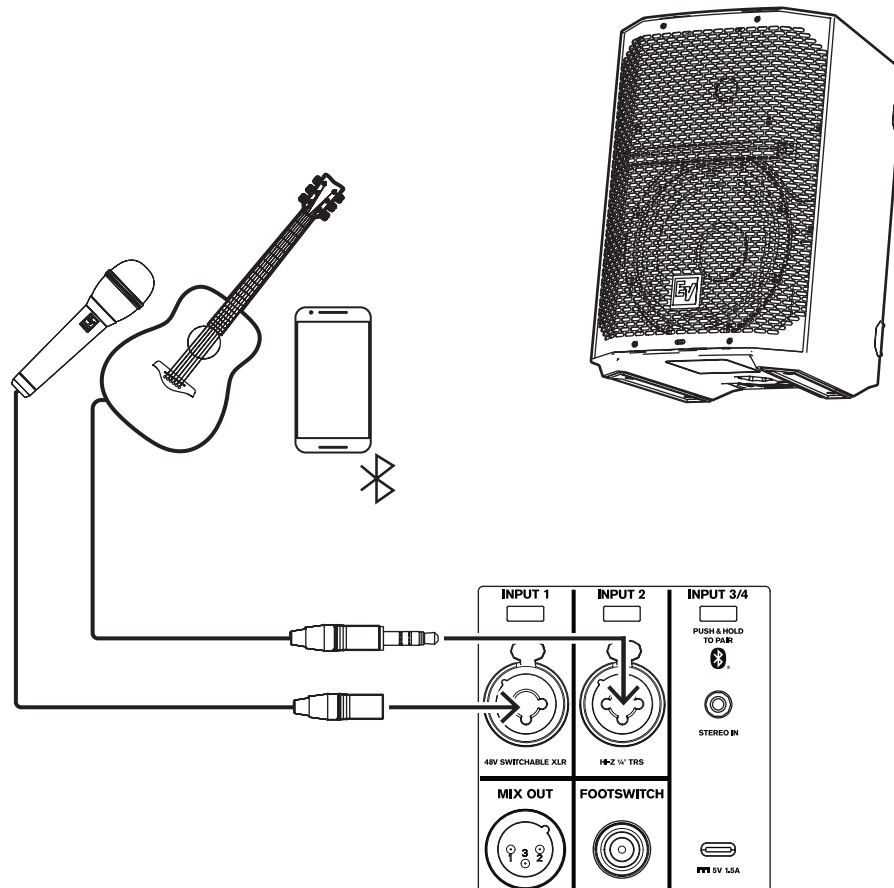

### Notice!

The direction of the arrow indicates the signal path.

MODE	LIVE
LOCATION	KICKBACK
SUB	OFF
INPUT 1 PRESET	VOCAL MIC
INPUT 2 PRESET	ACOUSTIC GTR

**Table 7.2:** DSP settings loudspeaker in kickback position

### 7.3 Bluetooth true wireless stereo (TWS)

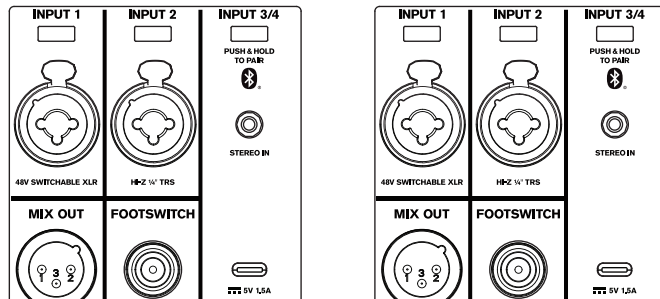
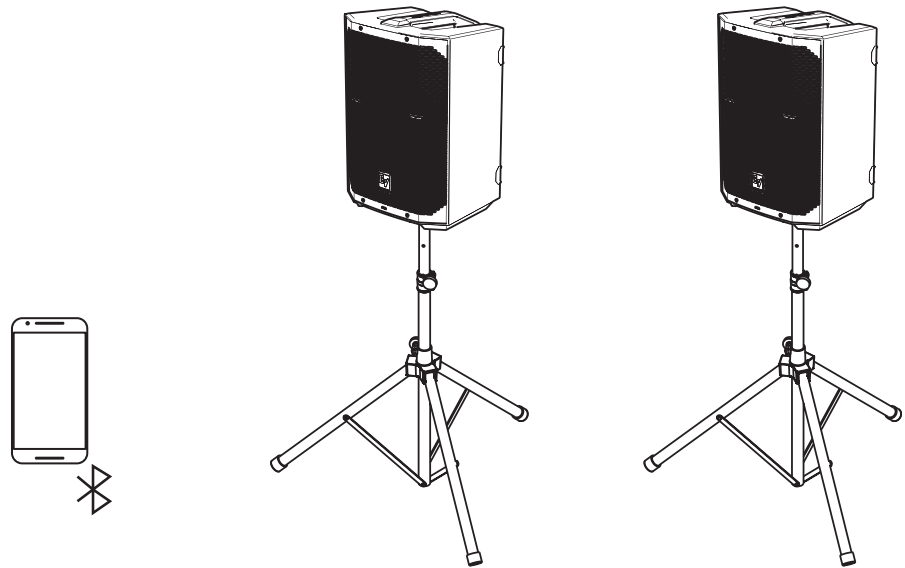

MODE	MUSIC
LOCATION	TRIPOD
SUB	OFF
INPUT PRESET	NONE

**Table 7.3:** DSP settings loudspeaker on a tripod

**To connect two loudspeakers via TWS:**

1. Connect one of the loudspeakers to your streaming device via Bluetooth®.
2. Select **LINK SPEAKERS** in the **BLUETOOTH** control menu on both loudspeakers.

## 7.4 Using as monitor

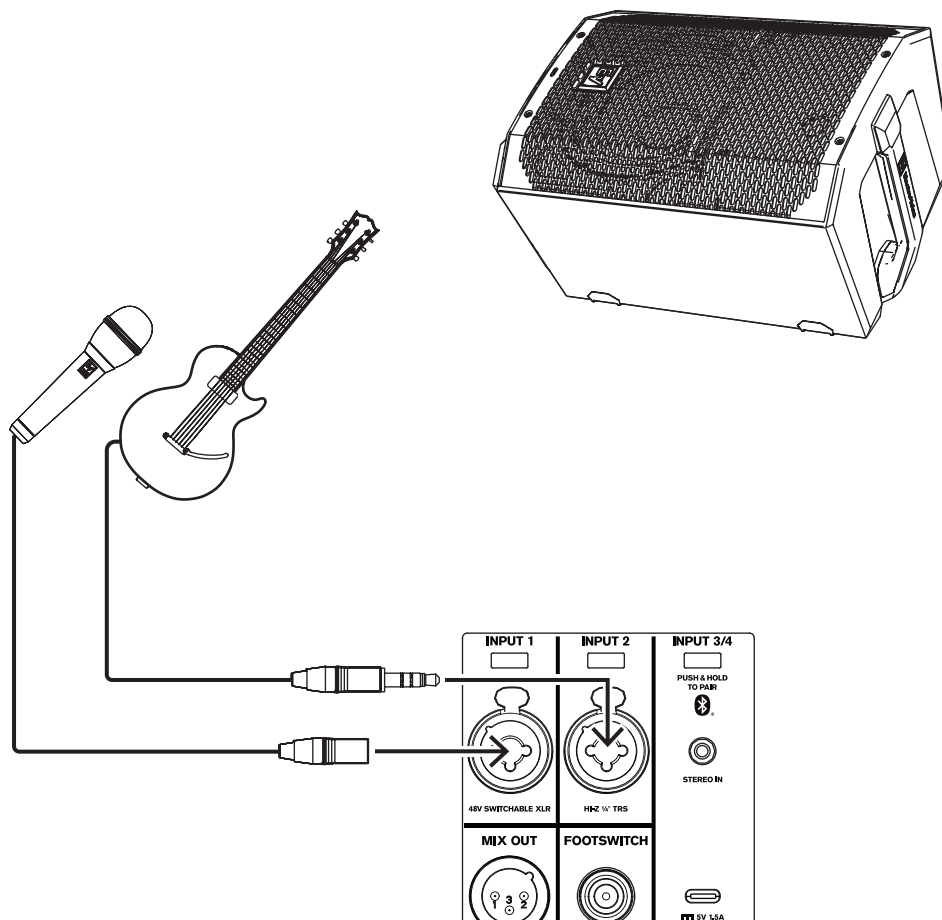

**Notice!**

The direction of the arrow indicates the signal path.

MODE	LIVE
LOCATION	MONITOR
SUB	OFF
INPUT 1 PRESET	VOCAL MIC
INPUT 2 PRESET	ELECTR GUIT

**Table 7.4:** DSP settings loudspeakers as monitors

## 8 Troubleshooting

Problem	Possible Cause(s)	Action
1. No sound	Improper gain	Verify all the sources are on. If the source is a condenser microphone, make sure the mic is plugged into <b>INPUT 1</b> via XLR and phantom power is enabled in the menu. Inspect the VU meters on LCD or in the app. If there is signal present on the VU meters, increase the input and gain controls to the required level. If there is no signal present on the VU meters, then check the wiring.
	Sources not connected	Check all cables between the source and the loudspeaker with a multimeter or cable tester. Replace any suspect cables with a known good cable.
2. Poor Low-Frequency Response	With <b>SUB</b> menu cross-over frequency activated	If no subwoofers are used with the system, select the <b>OFF</b> position.
	<b>SPEECH</b> mode is active	In the DSP control menu, change the <b>MODE</b> to <b>MUSIC</b> , <b>LIVE</b> , or <b>CLUB</b> . Refer to <i>DSP controls, page 29</i> for more details.
	Input <b>PRESET</b> is not set to <b>FLAT</b>	In the INPUT DSP control menu, change <b>PRESET</b> to <b>FLAT</b> . Refer to <i>INPUT DSP control menu, page 43</i> for more details.
	<b>EQ</b> is active	In the INPUT and DSP control menu, reset all EQs in the low frequencies. Refer to <i>DSP controls, page 29</i> and <i>INPUT DSP control menu, page 43</i> for more details.
3. Intermittent output such as cracking or distortion	Faulty connection	Check all connections at loudspeaker to ensure they are all clean and tight. If the problem persists, check the wiring. See problem 1.
4. Constant noise such as buzzing, hissing or humming	Defective source or other electronic device	If noise is present, but no program material is playing, evaluate each component as necessary to isolate the problem. Most likely there is a break in the signal path.
	Poor system grounding or ground loop	Check and correct the system grounding, as required.
	Input gain is not at a microphone level.	Slowly increase the INPUT LEVEL to engage the microphone pre-amp.
	Mobile device is connected via USB and 3.5 mm jack simultaneously.	Some mobile devices, such as laptops and mobile phones, may introduce ground loops if the loudspeaker is charging the mobile device while simultaneously connected via the 3.5 mm audio input jack. Connect the audio via Bluetooth®, or disconnect from the USB jack.

Problem	Possible Cause(s)	Action
5. No sound produced with microphone connected to <b>INPUT 1</b> or <b>INPUT 2</b>	Microphone requires phantom power.	Use a dynamic microphone that does not require phantom power. If using a microphone requiring phantom power, connect it to <b>INPUT 1</b> via the XLR connector and enable phantom power. Refer to <i>INPUT DSP control menu, page 43</i> for more details.
	Input gain is too low	Slowly increase the input gain knob level to engage the microphone pre-amp.
6. Sound is distorted, front <b>LED</b> is <b>OFF</b> , LCD screen <b>LIMIT</b> is <b>ON</b>	Excessive <b>INPUT LEVEL</b>	Reduce the <b>INPUT LEVEL</b> or loudspeaker level knobs to prevent limit.
	Incorrect gain structure or source input (mixing console/preamp) is overdriven	Verify level controls of the source are properly structured by using the VU meter indicator on the LCD screen. If the VU meter bar is solid or the system indicates <b>LIMIT</b> , the input or source level is too high.
7. Microphone produces acoustic feedback when <b>INPUT LEVEL</b> is amplified	Automatic Feedback Suppression is <b>OFF</b>	Enable Automatic Feedback Suppression in the DSP Control menu. Refer to <i>DSP controls, page 29</i> for more details.
	Incorrect gain structure	Reduce the microphone levels at the mixing console or input source. If the microphone is connected directly to the loudspeaker, reduce the <b>INPUT LEVEL</b> on the loudspeaker. Positioning the microphone close to the sound source increases gain-before-feedback. See problem 6.
	<b>MODE</b> is set to <b>MUSIC</b>	Change the <b>MODE</b> to <b>LIVE</b> or <b>SPEECH</b> .
	Microphone position is too close to the front of the loudspeaker	Whenever possible setup the loudspeakers so the microphone is behind them. If using the loudspeaker in a monitor position, aim the loudspeaker to the back of the microphone.
8. DSP control menu is locked	The menu <b>LOCK</b> function has been turned on. A lock symbol displays on the LCD screen.	Press the <b>MASTER VOL</b> knob or input selection soft keys to unlock.
9. QuickSmart Mobile app does not detect the loudspeaker	Enable Bluetooth®	Ensure Bluetooth® is enabled on the loudspeaker. For Android: ensure location services are activated. Remove loudspeaker from iOS/Android in device settings (sometimes called "FORGET"). Restart pairing. Ensure phone/tablet has required OS version and latest updates installed. Ensure the latest QuickSmart Mobile App is installed. Ensure no other phone/tablet is connected to the same loudspeaker.

<b>Problem</b>	<b>Possible Cause(s)</b>	<b>Action</b>
10. No reaction of loudspeaker to user interaction or power cycles	Unforeseen internal operation failure	Remove mains and battery, put battery back into loudspeaker. Or Press and hold soft key for <b>INPUT 1</b> and <b>INPUT 2</b> for at least 10 seconds.
If these suggestions do not solve your problem, contact your nearest Electro-Voice dealer or Electro-Voice distributor.		

## 9 Technical data

1) Full-space measurement using music DSP preset.

2) Half-space measurement at 1 m.

3) Maximum SPL is measured at 1 m using broadband pink noise at maximum output.

4) Current rating is 1/8 power.

5) Maximum output before loudspeaker limit indication, with typical program material

6) Moderate output with typical program material

7) Powering external devices via the DC power jack, USB connection, and/or phantom power will reduce battery run time.

	<b>EVERSE8-EU 8" 2-way speaker battery black EU</b> <b>EVERSE8-US 8" 2-way speaker battery black US</b>	<b>EVERSE8-W 8" 2-way speaker battery white US&amp;EU</b>
Frequency response (-3 dB) (Hz) <sup>1</sup>	60 Hz – 20,000 Hz	60 Hz – 20,000 Hz
Frequency range (-10 dB) (Hz) <sup>2</sup>	50 Hz – 20,000 Hz	50 Hz – 20,000 Hz
Maximum sound pressure level at a distance of 1 m (dB) <sup>3</sup>	121 dB	121 dB
Coverage angle HxV (°)	100° x 100°	100° x 100°
Amplifier rating (W)	400 W	400 W
LF transducer size (in)	8 in	8 in
LF transducer magnet material	Ferrite	Ferrite
HF transducer size (in)	1 in	1 in
HF transducer type	Compression driver	Compression driver
HF transducer diaphragm material	Titanium	Titanium
HF transducer magnet material	Neodymium	Neodymium
Crossover frequency (kHz)	2.25 kHz	2.25 kHz
Connector type	3.5 mm stereo jack; XLR/TRS combo jack; charge port; TRS footswitch; 12V DC power output	3.5 mm stereo jack; XLR/TRS combo jack, charge port; TRS footswitch; 12V DC power output
Enclosure	Polypropylene	Polypropylene
Grille material	Powder coated steel	Powder coated steel
USB charging	1.5 A max., device-dependent	1.5 A max., device-dependent
Color	Black	White
Dimensions (H x W x D) (mm)	400 mm x 275 mm x 272 mm	400 mm x 275 mm x 272 mm
Dimensions (H x W x D) (in)	15.75 in x 10.83 in x 10.71 in	15.75 in x 10.83 in x 10.71 in
Weight (kg)	7.60 kg	7.60 kg
Weight (lb)	16.80 lb	16.80 lb
Shipping weight (kg)	11 kg	11 kg

	<b>EVERSE8-EU 8" 2-way speaker battery black EU EVERSE8-US 8" 2-way speaker battery black US</b>	<b>EVERSE8-W 8" 2-way speaker battery white US&amp;EU</b>
Shipping weight (lb)	24.30 lb	24.30 lb
Power consumption (V, Hz, A) <sup>4</sup>	100 - 240 V~, 50 - 60 Hz, 0.8 - 0.6 A	100 - 240 V~, 50 - 60 Hz, 0.8 - 0.6 A
Battery capacity (Wh)	86.4 Wh	86.4 Wh
Battery run time (at max. output) <sup>5,7</sup> :	6+ hours	6+ hours
Battery run time (at 95 dB SPL) <sup>2,6,7</sup> :	12+ hours	12+ hours
Battery run time (at 100 dB SPL) <sup>2,6,7</sup> :	9+ hours	9+ hours

- 1) Full-space measurement using music DSP preset.
- 2) Half-space measurement at 1 m.
- 3) Maximum SPL is measured at 1 m using broadband pink noise at maximum output.
- 4) Current rating is 1/8 power.
- 5) Maximum output before loudspeaker limit indication, with typical program material
- 6) Moderate output with typical program material
- 7) Powering external devices via the DC power jack, USB connection, and/or phantom power will reduce battery run time.

	<b>EVERSE12-EU 12" 2-way speaker battery black EU EVERSE12-US 12" 2-way speaker battery black</b>	<b>EVERSE12-W 12" 2-way speaker battery white US&amp;EU</b>
Frequency response (-3 dB) (Hz) <sup>1</sup>	55 Hz – 20,000 Hz	55 Hz – 20,000 Hz
Frequency range (-10 dB) (Hz) <sup>2</sup>	45 Hz – 20,000 Hz	45 Hz – 20,000 Hz
Maximum sound pressure level at a distance of 1 m (dB) <sup>3</sup>	126 dB	126 dB
Coverage angle HxV (°)	100° x 60°	100° x 60°
Amplifier rating (W)	400 W	400 W
LF transducer size (in)	12 in	12 in
LF transducer magnet material	Ferrite	Ferrite
HF transducer size (in)	1 in	1 in
HF transducer type	Compression driver	Compression driver
HF transducer diaphragm material	Titanium	Titanium
HF transducer magnet material	Ferrite	Ferrite
Crossover frequency (kHz)	2 kHz	2 kHz

	<b>EVERSE12-EU 12" 2-way speaker battery black EU EVERSE12-US 12" 2-way speaker battery black</b>	<b>EVERSE12-W 12" 2-way speaker battery white US&amp;EU</b>
Connector type	3.5 mm stereo jack; XLR/TRS combo jack; charge port; TRS footswitch; 12V DC power output	3.5 mm stereo jack; XLR/TRS combo jack; charge port; TRS footswitch; 12V DC power output
Enclosure	Polypropylene	Polypropylene
Grille material	Powder coated steel	Powder coated steel
USB charging	1.5 A max., device-dependent	1.5 A max., device-dependent
Color	Black	White
Dimensions (H x W x D) (mm)	597 mm x 345 mm x 347 mm	597 mm x 345 mm x 347 mm
Dimensions (H x W x D) (in)	23.50 in x 13.58 in x 13.66 in	23.50 in x 13.58 in x 13.66 in
Weight (kg)	14.16 kg	14.16 kg
Weight (lb)	31.22 lb	31.22 lb
Shipping weight (kg)	16.34 kg	16.34 kg
Shipping weight (lb)	36.02 lb	36.02 lb
Power consumption (V, Hz, A) <sup>4</sup>	100 - 240 V~, 50 - 60 Hz, 1.2 - 0.6 A	100 - 240 V~, 50 - 60 Hz, 1.2 - 0.6 A
Battery capacity (Wh)	86.4 Wh	86.4 Wh
Battery run time (at max. output) <sup>5,7</sup> :	6+ hours	6+ hours
Battery run time (at 95 dB SPL) <sup>2,6,7</sup> :	14+ hours	14+ hours
Battery run time (at 100 dB SPL) <sup>2,6,7</sup> :	12+ hours	12+ hours

# 10 Appendices

## 10.1 Effects (FX) list

Note: Subject to change without notice

Number	Name App	Name LCD
0	OFF	OFF
1	Echo+ReverbShort	ECHO+REVERB S
2	Reverb Room	REV ROOM
3	Reverb Concert Hall	REV CONCERT
4	Reverb Large Hall	REV HALL
5	Reverb Church	REV CHURCH
6	Reverb Room Soft	REV ROOM S
7	Reverb Concert Hall Soft	REV CONCERT S
8	Reverb Large Hall Soft	REV HALL S
9	Reverb Church Soft	REV CHURCH S
10	Reverb Cathedral Soft	REV CATHEDRAL S
11	Reverb Plate Medium	PLATE MEDIUM
12	Reverb Plate Long	PLATE LONG
13	Reverb Plate Medium Soft	PLATE MEDIUM S
14	Reverb Plate Long Soft	PLATE LONG S
15	Reverb+ChorusSlow	REV+CHORUS SLOW
16	Reverb+ChorusMedium	REV+CHORUS MEDIUM
17	Reverb+ChorusFast	REV+CHORUS FAST
18	Delay Short	DELAY SHORT
19	Delay Long	DELAY LONG
20	Delay Tap	DELAY TAP
21	Chorus Slow	CHORUS SLOW
22	Chorus Medium	CHORUS MEDIUM
23	Chorus Fast	CHORUS FAST
24	Chorus+Echo Slow	CHORUS+ECHO S
25	Chorus+EchoMedium	CHORUS+ECHO M
26	Chorus+Echo Fast	CHORUS+ECHO F
27	Slap Back+EchoSlow	SLAPBACK+ECHO S
28	Slap Back+EchoFast	SLAPBACK+ECHO F
29	Doubling Narrow	DOUBLING NARROW
30	Doubling Wide	DOUBLING WIDE

## 10.2 FCC information

**IMPORTANT:** Do not modify this unit! Changes or modifications not expressly approved by the manufacturer could void the user's authority, granted by the FCC, to operate the equipment.



### Notice!

This equipment has been tested and found to comply with the limits for a Class B digital device, pursuant to Part 15 of the FCC Rules. These limits are designed to provide reasonable protection against harmful interference in a residential installation. This equipment generates, uses and can radiate radio frequency energy and, if not installed and used in accordance with the instructions, may cause harmful interference to radio communications. However, there is no guarantee interference will not occur in a particular installation.

If this equipment does cause harmful interference to radio or television reception or receive audible interference from radio, television or communications equipment, which can be determined by turning the equipment off and on. The user is encouraged to try to correct the interference by one or more of the following measures:

- Reorient or relocate the receiving antenna.
- Increase the separation between the equipment and receiver.
- Connect the equipment into an outlet on a circuit different from that to which the receiver is connected.
- Consult the dealer or an experienced radio/TV/communications equipment technician.

The device has been granted by FCC and IC, the FCC ID:ESVEVERSE and IC:1249A-EVERSE. Please take attention that changes or modification not expressly approved by the party responsible for compliance could void the user's authority to operate the equipment. This equipment should be installed and operated with a minimum distance of 20 cm between the radiator and your body.

This device complies with Industry Canada license-exempt RSS standard(s). Operation is subject to the following two conditions:

- (1) this device may not cause interference, and
- (2) this device must accept any interference, including interference that may cause undesired operation of the device.

Le présent appareil est conforme aux CNR d'Industrie Canada applicables aux appareils radioexempts de licence. L'exploitation est autorisée aux deux conditions suivantes :

- (1) l'appareil ne doit pas produire de brouillage, et
- (2) l'utilisateur de l'appareil doit accepter tout brouillage radioélectrique subi, même si le brouillage est susceptible d'en compromettre le fonctionnement.

Under Industry Canada regulations, this radio transmitter may only operate using an antenna of a type and maximum (or lesser) gain approved for the transmitter by Industry Canada. To reduce potential radio interference to other users, the antenna type and its gain should be so chosen that the equivalent isotropically radiated power (e.i.r.p.) is not more than that necessary for successful communication.

Conformément à la réglementation d'Industrie Canada, le présent émetteur radio peut fonctionner avec une antenne d'un type et d'un gain maximal (ou inférieur) approuvé pour l'émetteur par Industrie Canada. Dans le but de réduire les risques de brouillage radioélectrique à l'intention des autres utilisateurs, il faut choisir le type d'antenne et son gain de sorte que la puissance isotrope rayonnée équivalente (p.i.r.e.) ne dépasse pas l'intensité nécessaire à l'établissement d'une communication satisfaisante.

## 10.3 Simplified Declaration of Conformity (sDoC)

BG	С настоящото Bosch Security Systems, LLC декларира, че този тип радиосъоръжение EVERSE8-EU, EVERSE8-W, EVERSE12-EU, EVERSE12-W е в съответствие с Директива 2014/53/ЕС. Цялостният текст на ЕС декларацията за съответствие може да се намери на следния интернет адрес: <a href="http://www.electrovoice.com">www.electrovoice.com</a>
CS	Tímto Bosch Security Systems, LLC prohlašuje, že typ rádiového zařízení EVERSE8-EU, EVERSE8-W, EVERSE12-EU, EVERSE12-W je v souladu se směrnicí 2014/53/EU. Úplné znění EU prohlášení o shodě je k dispozici na této internetové adrese: <a href="http://www.electrovoice.com">www.electrovoice.com</a>
DA	Hermed erklærer Bosch Security Systems, LLC , at radioudstyrstypen EVERSE8-EU, EVERSE8-W, EVERSE12-EU, EVERSE12-W er i overensstemmelse med direktiv 2014/53/EU. EU-overensstemmelseserklæringens fulde tekst kan findes på følgende internetadresse: <a href="http://www.electrovoice.com">www.electrovoice.com</a>
DE	Hiermit erklärt Bosch Security Systems, LLC , dass der Funkanlagentyp EVERSE8-EU, EVERSE8-W, EVERSE12-EU, EVERSE12-W der Richtlinie 2014/53/EU entspricht. Der vollständige Text der EU-Konformitätserklärung ist unter der folgenden Internetadresse verfügbar: <a href="http://www.electrovoice.com">www.electrovoice.com</a>
EL	Με την παρούσα ο/η Bosch Security Systems, LLC , δηλώνει ότι ο ραδιοεξοπλισμός EVERSE8-EU, EVERSE8-W, EVERSE12-EU, EVERSE12-W πληροί την οδηγία 2014/53/ΕΕ. Το πλήρες κείμενο της δήλωσης συμμόρφωσης ΕΕ διατίθεται στην ακόλουθη ιστοσελίδα στο διαδίκτυο: <a href="http://www.electrovoice.com">www.electrovoice.com</a>
EN	Hereby, Bosch Security Systems, LLC declares that the radio equipment type EVERSE8-EU, EVERSE8-W, EVERSE12-EU, EVERSE12-W is in compliance with Directive 2014/53/EU and the relevant statutory requirements. The full text of the EU declaration of conformity is available at the following internet address: <a href="http://www.electrovoice.com">www.electrovoice.com</a> .
ES	Por la presente, Bosch Security Systems, LLC declara que el tipo de equipo radioeléctrico EVERSE8-EU, EVERSE8-W, EVERSE12-EU, EVERSE12-W es conforme con la Directiva 2014/53/UE. El texto completo de la declaración UE de conformidad está disponible en la dirección Internet siguiente: <a href="http://www.electrovoice.com">www.electrovoice.com</a> .
ET	Käesolevaga deklareerib Bosch Security Systems, LLC , et käesolev raadioseadme tüüp EVERSE8-EU, EVERSE8-W, EVERSE12-EU, EVERSE12-W vastab direktiivi 2014/53/EL nõuetele. ELi vastavusdeklaratsiooni täielik tekst on kättesaadav järgmisel internetiaadressil: <a href="http://www.electrovoice.com">www.electrovoice.com</a>
FI	Bosch Security Systems, LLC vakuuttaa, että radiolaitetyypit EVERSE8-EU, EVERSE8-W, EVERSE12-EU, EVERSE12-W on direktiivin 2014/53/EU mukainen. EU-vaatimusten mukaisuusvakuutuksen täysimittainen teksti on saatavilla seuraavassa internetosoitteessa: <a href="http://www.electrovoice.com">www.electrovoice.com</a>

FR	Le soussigné, Bosch Security Systems, LLC , déclare que l'équipement radioélectrique du type EVERSE8-EU, EVERSE8-W, EVERSE12-EU, EVERSE12-W est conforme à la directive 2014/53/UE. Le texte complet de la déclaration UE de conformité est disponible à l'adresse internet suivante: <a href="http://www.electrovoice.com">www.electrovoice.com</a>
HR	Bosch Security Systems, LLC ovime izjavljuje da je radijska oprema tipa EVERSE8-EU, EVERSE8-W, EVERSE12-EU, EVERSE12-W u skladu s Direktivom 2014/53/EU. Cjeloviti tekst EU izjave o sukladnosti dostupan je na sljedećoj internetskoj adresi: <a href="http://www.electrovoice.com">www.electrovoice.com</a>
HU	Bosch Security Systems, LLC igazolja, hogy a EVERSE8-EU, EVERSE8-W, EVERSE12-EU, EVERSE12-W típusú rádióberendezés megfelel a 2014/53/EU irányelvnek. Az EU-megfelelőségi nyilatkozat teljes szövege elérhető a következő internetes címen: <a href="http://www.electrovoice.com">www.electrovoice.com</a>
IT	Il fabbricante, Bosch Security Systems, LLC , dichiara che il tipo di apparecchiatura radio EVERSE8-EU, EVERSE8-W, EVERSE12-EU, EVERSE12-W è conforme alla direttiva 2014/53/UE. Il testo completo della dichiarazione di conformità UE è disponibile al seguente indirizzo Internet: <a href="http://www.electrovoice.com">www.electrovoice.com</a>
LT	Aš, Bosch Security Systems, LLC , patvirtinu, kad radijo įrenginių tipas EVERSE8-EU, EVERSE8-W, EVERSE12-EU, EVERSE12-W atitinka Direktyvą 2014/53/ES. Visas ES atitikties deklaracijos tekstas prieinamas šiuo interneto adresu: <a href="http://www.electrovoice.com">www.electrovoice.com</a>
LV	Ar šo Bosch Security Systems, LLC deklarē, ka radioiekārta EVERSE8-EU, EVERSE8-W, EVERSE12-EU, EVERSE12-W atbilst Direktīvai 2014/53/ES. Pilns ES atbilstības deklarācijas teksts ir pieejams šādā interneta vietnē: <a href="http://www.electrovoice.com">www.electrovoice.com</a>
MT	B'dan, Bosch Security Systems, LLC , niddikjara li dan it-tip ta' tagħmir tar-radju EVERSE8-EU, EVERSE8-W, EVERSE12-EU, EVERSE12-W huwa konformi mad-Direttiva 2014/53/UE. It-test kollu tad-dikjarazzjoni ta' konformità tal-UE huwa disponibbli f'dan l-indirizz tal-Internet li ġej: <a href="http://www.electrovoice.com">www.electrovoice.com</a>
NL	Hierbij verklaar ik, Bosch Security Systems, LLC , dat het type radioapparaatuur EVERSE8-EU, EVERSE8-W, EVERSE12-EU, EVERSE12-W conform is met Richtlijn 2014/53/EU. De volledige tekst van de EU-conformiteitsverklaring kan worden geraadpleegd op het volgende internetadres: <a href="http://www.electrovoice.com">www.electrovoice.com</a>
PL	Bosch Security Systems, LLC niniejszym oświadcza, że typ urządzenia radiowego EVERSE8-EU, EVERSE8-W, EVERSE12-EU, EVERSE12-W jest zgodny z dyrektywą 2014/53/UE. Pełny tekst deklaracji zgodności UE jest dostępny pod następującym adresem internetowym: <a href="http://www.electrovoice.com">www.electrovoice.com</a>
PT	O(a) abaixo assinado(a) Bosch Security Systems, LLC declara que o presente tipo de equipamento de rádio EVERSE8-EU, EVERSE8-W, EVERSE12-EU, EVERSE12-W está em conformidade com a Diretiva 2014/53/UE. O texto integral da declaração de conformidade está disponível no seguinte endereço de Internet: <a href="http://www.electrovoice.com">www.electrovoice.com</a>
RO	Prin prezenta, Bosch Security Systems, LLC declară că tipul de echipamente radio EVERSE8-EU, EVERSE8-W, EVERSE12-EU, EVERSE12-W este în conformitate cu Directiva 2014/53/UE. Textul integral al declarației UE de conformitate este disponibil la următoarea adresă internet: <a href="http://www.electrovoice.com">www.electrovoice.com</a>

SK	Bosch Security Systems, LLC týmto vyhlasuje, že rádiové zariadenie typu EVERSE8-EU, EVERSE8-W, EVERSE12-EU, EVERSE12-W je v súlade so smernicou 2014/53/EÚ. Úplné EÚ vyhlásenie o zhode je k dispozícii na tejto internetovej adrese: <a href="http://www.electrovoice.com">www.electrovoice.com</a>
SL	Bosch Security Systems, LLC potrjuje, da je tip radijske opreme EVERSE8-EU, EVERSE8-W, EVERSE12-EU, EVERSE12-W skladen z Direktivo 2014/53/EU. Celotno besedilo izjave EU o skladnosti je na voljo na naslednjem spletnem naslovu: <a href="http://www.electrovoice.com">www.electrovoice.com</a>
SV	Härmed försäkrar Bosch Security Systems, LLC att denna typ av radioutrustning EVERSE8-EU, EVERSE8-W, EVERSE12-EU, EVERSE12-W överensstämmer med direktiv 2014/53/EU. Den fullständiga texten till EU-försäkran om överensstämmelse finns på följande webbadress: <a href="http://www.electrovoice.com">www.electrovoice.com</a>

**For Europe:**

Frequency band of operation 2400 to 2483.5 MHz.

Maximum transmit power less than 20 dBm EIRP.

**10.4****Certifications****Argentina:**

EVERSE 8



Certificate number: RA 4184063 E

**Brazil:**

Após uma perturbação da rede elétrica, o EVERSE 8 e o EVERSE 12 podem entrar em estado de segurança. Neste caso, você deve desligar e ligar os dispositivos novamente.

Este equipamento não tem direito à proteção contra interferência prejudicial e não pode causar interferência em sistemas devidamente autorizados.

Este equipamento deve ser conectado obrigatoriamente em tomada de rede de energia elétrica que possua aterramento (três pinos), conforme a Norma de instalações elétricas ABNT NBR 5410, visando a segurança dos usuários contra choques elétricos.

Incorpora produto homologado pela ANATEL sob número 01000-24-07826.

Para mais informações, consulte o site da ANATEL: [www.anatel.gov.br](http://www.anatel.gov.br).

**Cambodia:**

EVERSE 8

TRC identifier: RF-TA-2022-0373

EVERSE 12

TRC identifier: RC-TA-2023-0703

**Malaysia:**

EVERSE 8 and EVERSE 12

**Mexico:**

“La operación de este equipo está sujeta a las siguientes dos condiciones: (1) es posible que este equipo o dispositivo no cause interferencia perjudicial y (2) este equipo o dispositivo debe aceptar cualquier interferencia, incluyendo la que pueda causar su operación no deseada”

EVERSE 8



IFETEL ID: ROELEV22-22223



EVERSE 12



IFETEL ID: ROELEV23-41397

**Morocco:**

EVERSE 8

EVERSE 12

**AGREE PAR L'ANRT MAROC**  
Numéro d'agrément  
**MR00034710ANRT2022**  
Date d'agrément  
**9 / 30 / 2022**

**AGREE PAR L'ANRT MAROC**  
Numéro d'agrément  
**MR00003247ANRT2024**  
Date d'agrément  
**7 / 23 / 2024**

**Pakistan:**  
EVERSE 8



EVERSE 12



**Republic of Korea:**  
EVERSE 8 and EVERSE 12



**R-R-B6S-ESVEVERSE**

기자재명칭:                    특정소출력 무선기기(무선데이터통신시스템용 무선기기)

모델명:                         EVERSE8 또는 EVERSE12

정격:	100-240 Vac, 50-60 Hz, 400 W
수입업체 (상호)명:	로버트보쉬코리아(유)
제 조자:	Bosch Security Systems, LLC.
제 조연월:	별도표기
제 조국:	중국
A/S:	02-702-2846

해당 무선설비는 운용 중 전파혼신 가능성이 있음

해당 무선설비는 전파혼신 가능성이 있으므로 인명안전과 관련된 서비스는 할 수 없습니다.

### Thailand:

เครื่องโทรคมนาคมและอุปกรณ์นี้มีความสอดคล้องตามมาตรฐานหรือข้อกำหนดทางเทคนิคของ กสทช.



เครื่องวิทยุคมนาคมนี้ ได้รับยกเว้น ไม่ต้องได้รับใบอนุญาตให้มี ใช้ซึ่งเครื่องวิทยุคมนาคมหรือตั้งสถานีวิทยุคมนาคมตามประกาศ กสทช. เรื่อง เครื่องวิทยุคมนาคม และสถานีวิทยุคมนาคมที่ได้รับยกเว้นไม่ต้องได้รับใบอนุญาตวิทยุคมนาคมตามพระราชบัญญัติวิทยุคมนาคม พ.ศ. 2498





โทรคมนาคม

ค่าบริการเพื่อประชาชน

Call Center 1200 (InSW)

### United Arab Emirates:

EVERSE 8



#### TDR A - UNITED ARAB Emirates

Dealer ID: DA45733/15  
TA RTTE: ER10360/22  
Model Name: EVERSE 8  
Product Type: Bluetooth



EVERSE 12



#### TDR A - UNITED ARAB Emirates

Dealer ID: DA0086756/12  
TA RTTE: ER28300/24  
Model Name: EVERSE 12  
Product Type: Bluetooth



## 10.5 OSS Licenses

### 10.5.1 Components overview

Component	Copyright	License
CMSIS	ARM Limited	Apache License 2.0
CMSIS Device	ARM Limited - STMicroelectronics	Apache License 2.0
STM32F4 HAL	STMicroelectronics	BSD-3-Clause
QTIL Firmware	Multiple	Multiple
QTIL Audio	Multiple	Multiple

### 10.5.2 The Licenses

#### Apache License 2.0

#### CMSIS and CMSIS Device

Apache License  
Version 2.0, January 2004  
<http://www.apache.org/licenses/>

#### TERMS AND CONDITIONS FOR USE, REPRODUCTION, AND DISTRIBUTION

##### 1. Definitions.

"License" shall mean the terms and conditions for use, reproduction, and distribution as defined by Sections 1 through 9 of this document.

"Licensor" shall mean the copyright owner or entity authorized by the copyright owner that is granting the License.

"Legal Entity" shall mean the union of the acting entity and all other entities that control, are controlled by, or are under common control with that entity. For the purposes of this definition, "control" means (i) the power, direct or indirect, to cause the direction or management of such entity, whether by contract or otherwise, or (ii) ownership of fifty percent (50%) or more of the outstanding shares, or (iii) beneficial ownership of such entity.

"You" (or "Your") shall mean an individual or Legal Entity exercising permissions granted by this License.

"Source" form shall mean the preferred form for making modifications, including but not limited to software source code, documentation source, and configuration files.

"Object" form shall mean any form resulting from mechanical transformation or translation of a Source form, including but not limited to compiled object code, generated documentation, and conversions to other media types.

"Work" shall mean the work of authorship, whether in Source or Object form, made available under the License, as indicated by a copyright notice that is included in or attached to the work (an example is provided in the Appendix below).

"Derivative Works" shall mean any work, whether in Source or Object form, that is based on (or derived from) the Work and for which the editorial revisions, annotations, elaborations, or other modifications represent, as a whole, an original work of authorship. For the purposes of this License, Derivative Works shall not include works that remain separable from, or merely link (or bind by name) to the interfaces of, the Work and Derivative Works thereof.

"Contribution" shall mean any work of authorship, including the original version of the Work and any modifications or additions to that Work or Derivative Works thereof, that is intentionally submitted to Licensor for inclusion in the Work by the copyright owner or by an individual or Legal Entity authorized to submit on behalf of the copyright owner. For the purposes of this definition, "submitted" means any form of electronic, verbal, or written communication sent to the Licensor or its representatives, including but not limited to communication on electronic mailing lists, source code control systems, and issue tracking systems that are managed by, or on behalf of, the Licensor for the purpose of discussing and improving the Work, but excluding communication that is conspicuously marked or otherwise designated in writing by the copyright owner as "Not a Contribution."

"Contributor" shall mean Licensor and any individual or Legal Entity on behalf of whom a Contribution has been received by Licensor and subsequently incorporated within the Work.

## **2. Grant of Copyright License.**

Subject to the terms and conditions of this License, each Contributor hereby grants to You a perpetual, worldwide, non-exclusive, no-charge, royalty-free, irrevocable copyright license to reproduce, prepare Derivative Works of, publicly display, publicly perform, sublicense, and distribute the Work and such Derivative Works in Source or Object form.

## **3. Grant of Patent License.**

Subject to the terms and conditions of this License, each Contributor hereby grants to You a perpetual, worldwide, non-exclusive, no-charge, royalty-free, irrevocable (except as stated in this section) patent license to make, have made, use, offer to sell, sell, import, and otherwise transfer the Work, where such license applies only to those patent claims licensable by such Contributor that are necessarily infringed by their Contribution(s) alone or by combination of their Contribution(s) with the Work to which such Contribution(s) was submitted. If You institute patent litigation against any entity (including a cross-claim or counterclaim in a lawsuit) alleging that the Work or a Contribution incorporated within the Work constitutes direct or contributory patent infringement, then any patent licenses granted to You under this License for that Work shall terminate as of the date such litigation is filed.

## **4. Redistribution.**

You may reproduce and distribute copies of the Work or Derivative Works thereof in any medium, with or without modifications, and in Source or Object form, provided that You meet the following conditions:

- (a) You must give any other recipients of the Work or Derivative Works a copy of this License; and
  - (b) You must cause any modified files to carry prominent notices stating that You changed the files; and
  - (c) You must retain, in the Source form of any Derivative Works that You distribute, all copyright, patent, trademark, and attribution notices from the Source form of the Work, excluding those notices that do not pertain to any part of the Derivative Works; and
  - (d) If the Work includes a "NOTICE" text file as part of its distribution, then any Derivative Works that You distribute must include a readable copy of the attribution notices contained within such NOTICE file, excluding those notices that do not pertain to any part of the Derivative Works, in at least one of the following places: within a NOTICE text file distributed as part of the Derivative Works; within the Source form or documentation, if provided along with the Derivative Works; or, within a display generated by the Derivative Works, if and wherever such third-party notices normally appear. The contents of the NOTICE file are for informational purposes only and do not modify the License. You may add Your own attribution notices within Derivative Works that You distribute, alongside or as an addendum to the NOTICE text from the Work, provided that such additional attribution notices cannot be construed as modifying the License.
- You may add Your own copyright statement to Your modifications and may provide additional or different license terms and conditions for use, reproduction, or distribution of Your modifications, or for any such Derivative Works as a whole, provided Your use, reproduction, and distribution of the Work otherwise complies with the conditions stated in this License.

#### **5. Submission of Contributions.**

Unless You explicitly state otherwise, any Contribution intentionally submitted for inclusion in the Work by You to the Licensor shall be under the terms and conditions of this License, without any additional terms or conditions. Notwithstanding the above, nothing herein shall supersede or modify the terms of any separate license agreement you may have executed with Licensor regarding such Contributions.

#### **6. Trademarks.**

This License does not grant permission to use the trade names, trademarks, service marks, or product names of the Licensor, except as required for reasonable and customary use in describing the origin of the Work and reproducing the content of the NOTICE file.

#### **7. Disclaimer of Warranty.**

Unless required by applicable law or agreed to in writing, Licensor provides the Work (and each Contributor provides its Contributions) on an "AS IS" BASIS, WITHOUT WARRANTIES OR CONDITIONS OF ANY KIND, either express or implied, including, without limitation, any warranties or conditions of TITLE, NON-INFRINGEMENT, MERCHANTABILITY, or FITNESS FOR A PARTICULAR PURPOSE. You are solely responsible for determining the appropriateness of using or redistributing the Work and assume any risks associated with Your exercise of permissions under this License.

#### **8. Limitation of Liability.**

In no event and under no legal theory, whether in tort (including negligence), contract, or otherwise, unless required by applicable law (such as deliberate and grossly negligent acts) or agreed to in writing, shall any Contributor be liable to You for damages, including any direct, indirect, special, incidental, or consequential damages of any character arising as a result of this License or out of the use or inability to use the Work (including but not limited

to damages for loss of goodwill, work stoppage, computer failure or malfunction, or any and all other commercial damages or losses), even if such Contributor has been advised of the possibility of such damages.

#### **9. Accepting Warranty or Additional Liability.**

While redistributing the Work or Derivative Works thereof, You may choose to offer, and charge a fee for, acceptance of support, warranty, indemnity, or other liability obligations and/or rights consistent with this License. However, in accepting such obligations, You may act only on Your own behalf and on Your sole responsibility, not on behalf of any other Contributor, and only if You agree to indemnify, defend, and hold each Contributor harmless for any liability incurred by, or claims asserted against, such Contributor by reason of your accepting any such warranty or additional liability.

END OF TERMS AND CONDITIONS

#### **APPENDIX: How to apply the Apache License to your work.**

To apply the Apache License to your work, attach the following boilerplate notice, with the fields enclosed by brackets "[ ]" replaced with your own identifying information. (Don't include the brackets!) The text should be enclosed in the appropriate comment syntax for the file format. We also recommend that a file or class name and description of purpose be included on the same "printed page" as the copyright notice for easier identification within third-party archives.

Copyright [yyyy] [name of copyright owner]

Licensed under the Apache License, Version 2.0 (the "License"); you may not use this file except in compliance with the License. You may obtain a copy of the License at <http://www.apache.org/licenses/LICENSE-2.0>

Unless required by applicable law or agreed to in writing, software distributed under the License is distributed on an "AS IS" BASIS, WITHOUT WARRANTIES OR CONDITIONS OF ANY KIND, either express or implied. See the License for the specific language governing permissions and limitations under the License.

#### **BSD-3-Clause License**

##### **STM32F4 HAL**

Redistribution and use in source and binary forms, with or without modification, are permitted provided that the following conditions are met:

1. Redistributions of source code must retain the above copyright notice, this list of conditions and the following disclaimer.
2. Redistributions in binary form must reproduce the above copyright notice, this list of conditions and the following disclaimer in the documentation and/or other materials provided with the distribution.
3. Neither the name of the copyright holder nor the names of its contributors may be used to endorse or promote products derived from this software without specific prior written permission.

THIS SOFTWARE IS PROVIDED BY THE COPYRIGHT HOLDERS AND CONTRIBUTORS "AS IS" AND ANY EXPRESS OR IMPLIED WARRANTIES, INCLUDING, BUT NOT LIMITED TO, THE IMPLIED WARRANTIES OF MERCHANTABILITY AND FITNESS FOR A PARTICULAR PURPOSE ARE DISCLAIMED. IN NO EVENT SHALL THE COPYRIGHT HOLDER OR CONTRIBUTORS BE LIABLE FOR ANY DIRECT, INDIRECT, INCIDENTAL, SPECIAL, EXEMPLARY, OR CONSEQUENTIAL DAMAGES (INCLUDING, BUT NOT LIMITED TO, PROCUREMENT OF SUBSTITUTE GOODS OR SERVICES; LOSS OF USE, DATA, OR PROFITS; OR BUSINESS INTERRUPTION) HOWEVER CAUSED AND ON ANY THEORY OF LIABILITY, WHETHER IN CONTRACT, STRICT LIABILITY, OR TORT (INCLUDING NEGLIGENCE OR OTHERWISE) ARISING IN ANY WAY OUT OF THE USE OF THIS SOFTWARE, EVEN IF ADVISED OF THE POSSIBILITY OF SUCH DAMAGE.

## Multiple License

### QTIL Firmware

This Notice txt file contains certain notices Qualcomm Technologies International, Ltd. ("QTIL") is required to provide with certain software components. Except where prohibited by the open source license, the content of this file is provided solely to satisfy QTIL's attribution and notice requirement and your use of such software components together with the QTIL software ("Software") is subject to the terms of your separate license from QTIL. Compliance with all copyright laws and software licenses included in this file are the responsibility of the user. Except as may be granted by separate express written agreement, this file provides no license to any patents, trademarks, copyrights, or other intellectual property of Qualcomm Incorporated or any of its subsidiaries.

Software provided with this notice is NOT A CONTRIBUTION to any open source project. If alternative licensing is available for any of the components with licenses or attributions provided below, a license choice is made for receiving such code by QTIL.

Copyright (c) 2017 Qualcomm Technologies International, Ltd. All rights reserved. Qualcomm is a trademark of Qualcomm Incorporated, registered in the United States and other countries. All Qualcomm Incorporated Trademarks are used with permission. Other products and brand names may be trademarks or registered trademarks of their respective owners.

\*

\* Copyright (c) 1998 Todd C. Miller <Todd.Miller@courtesan.com>

\*

\* Permission to use, copy, modify, and distribute this software for any  
\* purpose with or without fee is hereby granted, provided that the above  
\* copyright notice and this permission notice appear in all copies.

\*

\* THE SOFTWARE IS PROVIDED "AS IS" AND THE AUTHOR DISCLAIMS ALL WARRANTIES  
\* WITH REGARD TO THIS SOFTWARE INCLUDING ALL IMPLIED WARRANTIES OF  
\* MERCHANTABILITY AND FITNESS. IN NO EVENT SHALL THE AUTHOR BE LIABLE FOR  
\* ANY SPECIAL, DIRECT, INDIRECT, OR CONSEQUENTIAL DAMAGES OR ANY DAMAGES  
\* WHATSOEVER RESULTING FROM LOSS OF USE, DATA OR PROFITS, WHETHER IN AN  
\* ACTION OF CONTRACT, NEGLIGENCE OR OTHER TORTIOUS ACTION, ARISING OUT OF

\* OR IN CONNECTION WITH THE USE OR PERFORMANCE OF THIS SOFTWARE.  
\*/

\* Copyright (c) 1990 The Regents of the University of California.

\* All rights reserved.

\*

\* Redistribution and use in source and binary forms, with or without

\* modification, are permitted provided that the following conditions

\* are met:

\* 1. Redistributions of source code must retain the above copyright

\* notice, this list of conditions and the following disclaimer.

\* 2. Redistributions in binary form must reproduce the above copyright

\* notice, this list of conditions and the following disclaimer in the

\* documentation and/or other materials provided with the distribution.

\* 3. Neither the name of the University nor the names of its contributors

\* may be used to endorse or promote products derived from this software

\* without specific prior written permission.

\*

\* THIS SOFTWARE IS PROVIDED BY THE REGENTS AND CONTRIBUTORS ``AS IS" AND

\* ANY EXPRESS OR IMPLIED WARRANTIES, INCLUDING, BUT NOT LIMITED TO, THE

\* IMPLIED WARRANTIES OF MERCHANTABILITY AND FITNESS FOR A PARTICULAR PURPOSE

\* ARE DISCLAIMED. IN NO EVENT SHALL THE REGENTS OR CONTRIBUTORS BE LIABLE

\* FOR ANY DIRECT, INDIRECT, INCIDENTAL, SPECIAL, EXEMPLARY, OR CONSEQUENTIAL

\* DAMAGES (INCLUDING, BUT NOT LIMITED TO, PROCUREMENT OF SUBSTITUTE GOODS

\* OR SERVICES; LOSS OF USE, DATA, OR PROFITS; OR BUSINESS INTERRUPTION)

\* HOWEVER CAUSED AND ON ANY THEORY OF LIABILITY, WHETHER IN CONTRACT, STRICT

\* LIABILITY, OR TORT (INCLUDING NEGLIGENCE OR OTHERWISE) ARISING IN ANY WAY

\* OUT OF THE USE OF THIS SOFTWARE, EVEN IF ADVISED OF THE POSSIBILITY OF

\* SUCH DAMAGE.

### **QTIL Audio**

This Notice txt file contains certain notices Qualcomm Technologies International, Ltd. ("QTIL") is required to provide with certain software components. Except where prohibited by the open source license, the content of this file is provided solely to satisfy QTIL's attribution and notice requirement and your use of such software components together with the QTIL software ("Software") is subject to the terms of your separate license from QTIL. Compliance with all copyright laws and software licenses included in this file are the responsibility of the user. Except as may be granted by separate express written agreement, this file provides no license to any patents, trademarks, copyrights, or other intellectual property of Qualcomm Incorporated or any of its subsidiaries.

Software provided with this notice is NOT A CONTRIBUTION to any open source project. If alternative licensing is available for any of the components with licenses or attributions provided below, a license choice is made for receiving such code by QTIL.

Copyright (c) 2018 Qualcomm Technologies International, Ltd. All rights reserved.  
Qualcomm is a trademark of Qualcomm Incorporated, registered in the United States and other countries. All Qualcomm Incorporated Trademarks are used with permission. Other products and brand names may be trademarks or registered trademarks of their respective owners.

/\* Copyright (c) 2007-2008 CSIRO  
Copyright (c) 2007-2009 Xiph.Org Foundation  
Copyright (c) 2008 Gregory Maxwell  
Written by Jean-Marc Valin and Gregory Maxwell \*/  
/\*

Redistribution and use in source and binary forms, with or without modification, are permitted provided that the following conditions are met:  
Redistributions of source code must retain the above copyright notice, this list of conditions and the following disclaimer.  
Redistributions in binary form must reproduce the above copyright notice, this list of conditions and the following disclaimer in the documentation and/or other materials provided with the distribution.  
Neither the name of the Xiph.org Foundation nor the names of its contributors may be used to endorse or promote products derived from this software without specific prior written permission.

THIS SOFTWARE IS PROVIDED BY THE COPYRIGHT HOLDERS AND CONTRIBUTORS "AS IS" AND ANY EXPRESS OR IMPLIED WARRANTIES, INCLUDING, BUT NOT LIMITED TO, THE IMPLIED WARRANTIES OF MERCHANTABILITY AND FITNESS FOR A PARTICULAR PURPOSE ARE DISCLAIMED. IN NO EVENT SHALL THE FOUNDATION OR CONTRIBUTORS BE LIABLE FOR ANY DIRECT, INDIRECT, INCIDENTAL, SPECIAL, EXEMPLARY, OR CONSEQUENTIAL DAMAGES (INCLUDING, BUT NOT LIMITED TO, PROCUREMENT OF SUBSTITUTE GOODS OR SERVICES; LOSS OF USE, DATA, OR PROFITS; OR BUSINESS INTERRUPTION) HOWEVER CAUSED AND ON ANY THEORY OF LIABILITY, WHETHER IN CONTRACT, STRICT LIABILITY, OR TORT (INCLUDING NEGLIGENCE OR OTHERWISE) ARISING IN ANY WAY OUT OF THE USE OF THIS SOFTWARE, EVEN IF ADVISED OF THE POSSIBILITY OF SUCH DAMAGE.  
\*/

Copyright (c) 2003-2004, Mark Borgerding

All rights reserved.

Redistribution and use in source and binary forms, with or without modification, are permitted provided that the following conditions are met:  
\* Redistributions of source code must retain the above copyright notice, this list of conditions and the following disclaimer.  
\* Redistributions in binary form must reproduce the above copyright notice, this list of conditions and the following disclaimer in the documentation and/or other materials provided with the distribution.

THIS SOFTWARE IS PROVIDED BY THE COPYRIGHT HOLDERS AND CONTRIBUTORS "AS IS" AND ANY EXPRESS OR IMPLIED WARRANTIES, INCLUDING, BUT NOT LIMITED TO, THE IMPLIED WARRANTIES OF MERCHANTABILITY AND FITNESS FOR A PARTICULAR PURPOSE

ARE DISCLAIMED. IN NO EVENT SHALL THE COPYRIGHT OWNER OR CONTRIBUTORS BE LIABLE FOR ANY DIRECT, INDIRECT, INCIDENTAL, SPECIAL, EXEMPLARY, OR CONSEQUENTIAL DAMAGES (INCLUDING, BUT NOT LIMITED TO, PROCUREMENT OF SUBSTITUTE GOODS OR SERVICES; LOSS OF USE, DATA, OR PROFITS; OR BUSINESS INTERRUPTION) HOWEVER CAUSED AND ON ANY THEORY OF LIABILITY, WHETHER IN CONTRACT, STRICT LIABILITY, OR TORT (INCLUDING NEGLIGENCE OR OTHERWISE) ARISING IN ANY WAY OUT OF THE USE OF THIS SOFTWARE, EVEN IF ADVISED OF THE POSSIBILITY OF SUCH DAMAGE.

Copyright (c) 2003-2008 Jean-Marc Valin  
Copyright (c) 2007-2008 CSIRO  
Copyright (c) 2007-2009 Xiph.Org Foundation  
Written by Jean-Marc Valin

Redistribution and use in source and binary forms, with or without modification, are permitted provided that the following conditions are met:

- Redistributions of source code must retain the above copyright notice, this list of conditions and the following disclaimer.
- Redistributions in binary form must reproduce the above copyright notice, this list of conditions and the following disclaimer in the documentation and/or other materials provided with the distribution.

THIS SOFTWARE IS PROVIDED BY THE COPYRIGHT HOLDERS AND CONTRIBUTORS ``AS IS'' AND ANY EXPRESS OR IMPLIED WARRANTIES, INCLUDING, BUT NOT LIMITED TO, THE IMPLIED WARRANTIES OF MERCHANTABILITY AND FITNESS FOR A PARTICULAR PURPOSE ARE DISCLAIMED. IN NO EVENT SHALL THE COPYRIGHT OWNER OR CONTRIBUTORS BE LIABLE FOR ANY DIRECT, INDIRECT, INCIDENTAL, SPECIAL, EXEMPLARY, OR CONSEQUENTIAL DAMAGES (INCLUDING, BUT NOT LIMITED TO, PROCUREMENT OF SUBSTITUTE GOODS OR SERVICES; LOSS OF USE, DATA, OR PROFITS; OR BUSINESS INTERRUPTION) HOWEVER CAUSED AND ON ANY THEORY OF LIABILITY, WHETHER IN CONTRACT, STRICT LIABILITY, OR TORT (INCLUDING NEGLIGENCE OR OTHERWISE) ARISING IN ANY WAY OUT OF THE USE OF THIS SOFTWARE, EVEN IF ADVISED OF THE POSSIBILITY OF SUCH DAMAGE.

Copyright (c) 2007-2008 CSIRO  
Copyright (c) 2007-2009 Xiph.Org Foundation  
Copyright (c) 2008-2009 Gregory Maxwell  
Written by Jean-Marc Valin and Gregory Maxwell

Redistribution and use in source and binary forms, with or without modification, are permitted provided that the following conditions are met:

- Redistributions of source code must retain the above copyright notice, this list of conditions and the following disclaimer.
- Redistributions in binary form must reproduce the above copyright notice, this list of conditions and the following disclaimer in the documentation and/or other materials provided with the distribution.

THIS SOFTWARE IS PROVIDED BY THE COPYRIGHT HOLDERS AND CONTRIBUTORS ``AS IS'' AND ANY EXPRESS OR IMPLIED WARRANTIES, INCLUDING, BUT NOT LIMITED TO, THE IMPLIED WARRANTIES OF MERCHANTABILITY AND FITNESS FOR A PARTICULAR PURPOSE ARE DISCLAIMED. IN NO EVENT SHALL THE COPYRIGHT OWNER OR CONTRIBUTORS BE LIABLE FOR ANY DIRECT, INDIRECT, INCIDENTAL, SPECIAL, EXEMPLARY, OR CONSEQUENTIAL DAMAGES (INCLUDING, BUT NOT LIMITED TO, PROCUREMENT OF SUBSTITUTE GOODS OR SERVICES; LOSS OF USE, DATA, OR PROFITS; OR BUSINESS INTERRUPTION) HOWEVER CAUSED AND ON ANY THEORY OF LIABILITY, WHETHER IN CONTRACT, STRICT LIABILITY, OR TORT (INCLUDING NEGLIGENCE OR OTHERWISE) ARISING IN ANY WAY OUT OF THE USE OF THIS SOFTWARE, EVEN IF ADVISED OF THE POSSIBILITY OF SUCH DAMAGE.

Copyright (c) 2007-2008 CSIRO  
Copyright (c) 2007-2010 Xiph.Org Foundation  
Copyright (c) 2008 Gregory Maxwell  
Written by Jean-Marc Valin and Gregory Maxwell

Redistribution and use in source and binary forms, with or without modification, are permitted provided that the following conditions are met:

- Redistributions of source code must retain the above copyright notice, this list of conditions and the following disclaimer.
- Redistributions in binary form must reproduce the above copyright notice, this list of conditions and the following disclaimer in the documentation and/or other materials provided with the distribution.

THIS SOFTWARE IS PROVIDED BY THE COPYRIGHT HOLDERS AND CONTRIBUTORS ``AS IS'' AND ANY EXPRESS OR IMPLIED WARRANTIES, INCLUDING, BUT NOT LIMITED TO, THE IMPLIED WARRANTIES OF MERCHANTABILITY AND FITNESS FOR A PARTICULAR PURPOSE ARE DISCLAIMED. IN NO EVENT SHALL THE COPYRIGHT OWNER OR CONTRIBUTORS BE LIABLE FOR ANY DIRECT, INDIRECT, INCIDENTAL, SPECIAL, EXEMPLARY, OR CONSEQUENTIAL DAMAGES (INCLUDING, BUT NOT LIMITED TO, PROCUREMENT OF SUBSTITUTE GOODS OR SERVICES; LOSS OF USE, DATA, OR PROFITS; OR BUSINESS INTERRUPTION) HOWEVER CAUSED AND ON ANY THEORY OF LIABILITY, WHETHER IN CONTRACT, STRICT LIABILITY, OR TORT (INCLUDING NEGLIGENCE OR OTHERWISE) ARISING IN ANY WAY OUT OF THE USE OF THIS SOFTWARE, EVEN IF ADVISED OF THE POSSIBILITY OF SUCH DAMAGE.

Copyright (c) 2011, Skype Limited. All rights reserved.

Redistribution and use in source and binary forms, with or without modification, are permitted provided that the following conditions are met:

- Redistributions of source code must retain the above copyright notice, this list of conditions and the following disclaimer.
- Redistributions in binary form must reproduce the above copyright notice, this list of conditions and the following disclaimer in the documentation and/or other materials provided with the distribution.
- Neither the name of Internet Society, IETF or IETF Trust, nor the names of specific contributors, may be used to endorse or promote products derived from this software without specific prior written permission.

THIS SOFTWARE IS PROVIDED BY THE COPYRIGHT HOLDERS AND CONTRIBUTORS "AS IS" AND ANY EXPRESS OR IMPLIED WARRANTIES, INCLUDING, BUT NOT LIMITED TO, THE IMPLIED WARRANTIES OF MERCHANTABILITY AND FITNESS FOR A PARTICULAR PURPOSE ARE DISCLAIMED. IN NO EVENT SHALL THE COPYRIGHT OWNER OR CONTRIBUTORS BE LIABLE FOR ANY DIRECT, INDIRECT, INCIDENTAL, SPECIAL, EXEMPLARY, OR CONSEQUENTIAL DAMAGES (INCLUDING, BUT NOT LIMITED TO, PROCUREMENT OF SUBSTITUTE GOODS OR SERVICES; LOSS OF USE, DATA, OR PROFITS; OR BUSINESS INTERRUPTION) HOWEVER CAUSED AND ON ANY THEORY OF LIABILITY, WHETHER IN CONTRACT, STRICT LIABILITY, OR TORT (INCLUDING NEGLIGENCE OR OTHERWISE) ARISING IN ANY WAY OUT OF THE USE OF THIS SOFTWARE, EVEN IF ADVISED OF THE POSSIBILITY OF SUCH DAMAGE.

Copyright (c) 2007-2008 CSIRO  
Copyright (c) 2007-2009 Xiph.Org Foundation  
Copyright (c) 2007-2009 Timothy B. Terriberry  
Written by Timothy B. Terriberry and Jean-Marc Valin

Redistribution and use in source and binary forms, with or without modification, are permitted provided that the following conditions are met:

- Redistributions of source code must retain the above copyright notice, this list of conditions and the following disclaimer.
- Redistributions in binary form must reproduce the above copyright notice, this list of conditions and the following disclaimer in the documentation and/or other materials provided with the distribution.

THIS SOFTWARE IS PROVIDED BY THE COPYRIGHT HOLDERS AND CONTRIBUTORS ``AS IS'' AND ANY EXPRESS OR IMPLIED WARRANTIES, INCLUDING, BUT NOT LIMITED TO, THE IMPLIED WARRANTIES OF MERCHANTABILITY AND FITNESS FOR A PARTICULAR PURPOSE ARE DISCLAIMED. IN NO EVENT SHALL THE COPYRIGHT OWNER OR CONTRIBUTORS BE LIABLE FOR ANY DIRECT, INDIRECT, INCIDENTAL, SPECIAL, EXEMPLARY, OR CONSEQUENTIAL DAMAGES (INCLUDING, BUT NOT LIMITED TO, PROCUREMENT OF SUBSTITUTE GOODS OR SERVICES; LOSS OF USE, DATA, OR PROFITS; OR BUSINESS INTERRUPTION) HOWEVER CAUSED AND ON ANY THEORY OF LIABILITY, WHETHER IN CONTRACT, STRICT LIABILITY, OR TORT (INCLUDING NEGLIGENCE OR OTHERWISE) ARISING IN ANY WAY OUT OF THE USE OF THIS SOFTWARE, EVEN IF ADVISED OF THE POSSIBILITY OF SUCH DAMAGE.

Copyright (c) 2003-2008 Timothy B. Terriberry  
Copyright (c) 2008 Xiph.Org Foundation

Redistribution and use in source and binary forms, with or without modification, are permitted provided that the following conditions are met:

- Redistributions of source code must retain the above copyright notice, this list of conditions and the following disclaimer.
- Redistributions in binary form must reproduce the above copyright notice, this list of conditions and the following disclaimer in the documentation and/or other materials provided with the distribution.

THIS SOFTWARE IS PROVIDED BY THE COPYRIGHT HOLDERS AND CONTRIBUTORS ``AS IS'' AND ANY EXPRESS OR IMPLIED WARRANTIES, INCLUDING, BUT NOT LIMITED TO, THE IMPLIED WARRANTIES OF MERCHANTABILITY AND FITNESS FOR A PARTICULAR PURPOSE ARE DISCLAIMED. IN NO EVENT SHALL THE COPYRIGHT OWNER OR CONTRIBUTORS BE LIABLE FOR ANY DIRECT, INDIRECT, INCIDENTAL, SPECIAL, EXEMPLARY, OR CONSEQUENTIAL DAMAGES (INCLUDING, BUT NOT LIMITED TO, PROCUREMENT OF SUBSTITUTE GOODS OR SERVICES; LOSS OF USE, DATA, OR PROFITS; OR BUSINESS INTERRUPTION) HOWEVER CAUSED AND ON ANY THEORY OF LIABILITY, WHETHER IN CONTRACT, STRICT LIABILITY, OR TORT (INCLUDING NEGLIGENCE OR OTHERWISE) ARISING IN ANY WAY OUT OF THE USE OF THIS SOFTWARE, EVEN IF ADVISED OF THE POSSIBILITY OF SUCH DAMAGE.

Copyright (c) 2001-2011 Timothy B. Terriberry

Redistribution and use in source and binary forms, with or without modification, are permitted provided that the following conditions are met:

- Redistributions of source code must retain the above copyright notice, this list of conditions and the following disclaimer.
- Redistributions in binary form must reproduce the above copyright notice, this list of conditions and the following disclaimer in the documentation and/or other materials provided with the distribution.

THIS SOFTWARE IS PROVIDED BY THE COPYRIGHT HOLDERS AND CONTRIBUTORS ``AS IS'' AND ANY EXPRESS OR IMPLIED WARRANTIES, INCLUDING, BUT NOT LIMITED TO, THE IMPLIED WARRANTIES OF MERCHANTABILITY AND FITNESS FOR A PARTICULAR PURPOSE ARE DISCLAIMED. IN NO EVENT SHALL THE COPYRIGHT OWNER OR CONTRIBUTORS BE LIABLE FOR ANY DIRECT, INDIRECT, INCIDENTAL, SPECIAL, EXEMPLARY, OR CONSEQUENTIAL DAMAGES (INCLUDING, BUT NOT LIMITED TO, PROCUREMENT OF SUBSTITUTE GOODS OR SERVICES; LOSS OF USE, DATA, OR PROFITS; OR BUSINESS INTERRUPTION) HOWEVER CAUSED AND ON ANY THEORY OF LIABILITY, WHETHER IN CONTRACT, STRICT LIABILITY, OR TORT (INCLUDING NEGLIGENCE OR OTHERWISE) ARISING IN ANY WAY OUT OF THE USE OF THIS SOFTWARE, EVEN IF ADVISED OF THE POSSIBILITY OF SUCH DAMAGE.

Copyright (c) 2001-2011 Timothy B. Terriberry

Copyright (c) 2008-2009 Xiph.Org Foundation

Redistribution and use in source and binary forms, with or without modification, are permitted provided that the following conditions are met:

- Redistributions of source code must retain the above copyright notice, this list of conditions and the following disclaimer.
- Redistributions in binary form must reproduce the above copyright notice, this list of conditions and the following disclaimer in the documentation and/or other materials provided with the distribution.

THIS SOFTWARE IS PROVIDED BY THE COPYRIGHT HOLDERS AND CONTRIBUTORS ``AS IS'' AND ANY EXPRESS OR IMPLIED WARRANTIES, INCLUDING, BUT NOT LIMITED TO, THE IMPLIED WARRANTIES OF MERCHANTABILITY AND FITNESS FOR A PARTICULAR PURPOSE ARE DISCLAIMED. IN NO EVENT SHALL THE COPYRIGHT OWNER OR CONTRIBUTORS BE

LIABLE FOR ANY DIRECT, INDIRECT, INCIDENTAL, SPECIAL, EXEMPLARY, OR CONSEQUENTIAL DAMAGES (INCLUDING, BUT NOT LIMITED TO, PROCUREMENT OF SUBSTITUTE GOODS OR SERVICES; LOSS OF USE, DATA, OR PROFITS; OR BUSINESS INTERRUPTION) HOWEVER CAUSED AND ON ANY THEORY OF LIABILITY, WHETHER IN CONTRACT, STRICT LIABILITY, OR TORT (INCLUDING NEGLIGENCE OR OTHERWISE) ARISING IN ANY WAY OUT OF THE USE OF THIS SOFTWARE, EVEN IF ADVISED OF THE POSSIBILITY OF SUCH DAMAGE.

Copyright (C) 2007-2009 Xiph.Org Foundation

Copyright (C) 2003-2008 Jean-Marc Valin

Copyright (C) 2007-2008 CSIRO

Redistribution and use in source and binary forms, with or without modification, are permitted provided that the following conditions are met:

- Redistributions of source code must retain the above copyright notice, this list of conditions and the following disclaimer.
- Redistributions in binary form must reproduce the above copyright notice, this list of conditions and the following disclaimer in the documentation and/or other materials provided with the distribution.

THIS SOFTWARE IS PROVIDED BY THE COPYRIGHT HOLDERS AND CONTRIBUTORS ``AS IS'' AND ANY EXPRESS OR IMPLIED WARRANTIES, INCLUDING, BUT NOT LIMITED TO, THE IMPLIED WARRANTIES OF MERCHANTABILITY AND FITNESS FOR A PARTICULAR PURPOSE ARE DISCLAIMED. IN NO EVENT SHALL THE COPYRIGHT OWNER OR CONTRIBUTORS BE LIABLE FOR ANY DIRECT, INDIRECT, INCIDENTAL, SPECIAL, EXEMPLARY, OR CONSEQUENTIAL DAMAGES (INCLUDING, BUT NOT LIMITED TO, PROCUREMENT OF SUBSTITUTE GOODS OR SERVICES; LOSS OF USE, DATA, OR PROFITS; OR BUSINESS INTERRUPTION) HOWEVER CAUSED AND ON ANY THEORY OF LIABILITY, WHETHER IN CONTRACT, STRICT LIABILITY, OR TORT (INCLUDING NEGLIGENCE OR OTHERWISE) ARISING IN ANY WAY OUT OF THE USE OF THIS SOFTWARE, EVEN IF ADVISED OF THE POSSIBILITY OF SUCH DAMAGE.

Copyright (c) 2003-2004, Mark Borgerding

Lots of modifications by Jean-Marc Valin

Copyright (c) 2005-2007, Xiph.Org Foundation

Copyright (c) 2008, Xiph.Org Foundation, CSIRO

All rights reserved.

Redistribution and use in source and binary forms, with or without modification, are permitted provided that the following conditions are met:

- \* Redistributions of source code must retain the above copyright notice, this list of conditions and the following disclaimer.
- \* Redistributions in binary form must reproduce the above copyright notice, this list of conditions and the following disclaimer in the documentation and/or other materials provided with the distribution.

THIS SOFTWARE IS PROVIDED BY THE COPYRIGHT HOLDERS AND CONTRIBUTORS "AS IS" AND ANY EXPRESS OR IMPLIED WARRANTIES, INCLUDING, BUT NOT LIMITED TO, THE IMPLIED WARRANTIES OF MERCHANTABILITY AND FITNESS FOR A PARTICULAR PURPOSE ARE DISCLAIMED. IN NO EVENT SHALL THE COPYRIGHT OWNER OR CONTRIBUTORS BE LIABLE FOR ANY DIRECT, INDIRECT, INCIDENTAL, SPECIAL, EXEMPLARY, OR CONSEQUENTIAL DAMAGES (INCLUDING, BUT NOT LIMITED TO, PROCUREMENT OF SUBSTITUTE GOODS OR SERVICES; LOSS OF USE, DATA, OR PROFITS; OR BUSINESS INTERRUPTION) HOWEVER CAUSED AND ON ANY THEORY OF LIABILITY, WHETHER IN CONTRACT, STRICT LIABILITY, OR TORT (INCLUDING NEGLIGENCE OR OTHERWISE) ARISING IN ANY WAY OUT OF THE USE OF THIS SOFTWARE, EVEN IF ADVISED OF THE POSSIBILITY OF SUCH DAMAGE.\* /

Copyright (c) 2003-2004, Mark Borgerding  
Lots of modifications by Jean-Marc Valin  
Copyright (c) 2005-2007, Xiph.Org Foundation  
Copyright (c) 2008, Xiph.Org Foundation, CSIRO

All rights reserved.

Redistribution and use in source and binary forms, with or without modification, are permitted provided that the following conditions are met:

\* Redistributions of source code must retain the above copyright notice, this list of conditions and the following disclaimer.

\* Redistributions in binary form must reproduce the above copyright notice, this list of conditions and the following disclaimer in the documentation and/or other materials provided with the distribution.

THIS SOFTWARE IS PROVIDED BY THE COPYRIGHT HOLDERS AND CONTRIBUTORS "AS IS" AND ANY EXPRESS OR IMPLIED WARRANTIES, INCLUDING, BUT NOT LIMITED TO, THE IMPLIED WARRANTIES OF MERCHANTABILITY AND FITNESS FOR A PARTICULAR PURPOSE ARE DISCLAIMED. IN NO EVENT SHALL THE COPYRIGHT OWNER OR CONTRIBUTORS BE LIABLE FOR ANY DIRECT, INDIRECT, INCIDENTAL, SPECIAL, EXEMPLARY, OR CONSEQUENTIAL DAMAGES (INCLUDING, BUT NOT LIMITED TO, PROCUREMENT OF SUBSTITUTE GOODS OR SERVICES; LOSS OF USE, DATA, OR PROFITS; OR BUSINESS INTERRUPTION) HOWEVER CAUSED AND ON ANY THEORY OF LIABILITY, WHETHER IN CONTRACT, STRICT LIABILITY, OR TORT (INCLUDING NEGLIGENCE OR OTHERWISE) ARISING IN ANY WAY OUT OF THE USE OF THIS SOFTWARE, EVEN IF ADVISED OF THE POSSIBILITY OF SUCH DAMAGE.

Copyright (c) 2007 CSIRO  
Copyright (c) 2007-2009 Xiph.Org Foundation  
Written by Jean-Marc Valin

Redistribution and use in source and binary forms, with or without modification, are permitted provided that the following conditions are met:

– Redistributions of source code must retain the above copyright notice, this list of conditions and the following disclaimer.

- Redistributions in binary form must reproduce the above copyright notice, this list of conditions and the following disclaimer in the documentation and/or other materials provided with the distribution.

THIS SOFTWARE IS PROVIDED BY THE COPYRIGHT HOLDERS AND CONTRIBUTORS ``AS IS'' AND ANY EXPRESS OR IMPLIED WARRANTIES, INCLUDING, BUT NOT LIMITED TO, THE IMPLIED WARRANTIES OF MERCHANTABILITY AND FITNESS FOR A PARTICULAR PURPOSE ARE DISCLAIMED. IN NO EVENT SHALL THE COPYRIGHT OWNER OR CONTRIBUTORS BE LIABLE FOR ANY DIRECT, INDIRECT, INCIDENTAL, SPECIAL, EXEMPLARY, OR CONSEQUENTIAL DAMAGES (INCLUDING, BUT NOT LIMITED TO, PROCUREMENT OF SUBSTITUTE GOODS OR SERVICES; LOSS OF USE, DATA, OR PROFITS; OR BUSINESS INTERRUPTION) HOWEVER CAUSED AND ON ANY THEORY OF LIABILITY, WHETHER IN CONTRACT, STRICT LIABILITY, OR TORT (INCLUDING NEGLIGENCE OR OTHERWISE) ARISING IN ANY WAY OUT OF THE USE OF THIS SOFTWARE, EVEN IF ADVISED OF THE POSSIBILITY OF SUCH DAMAGE.

Copyright (c) 2002-2008 Jean-Marc Valin  
Copyright (c) 2007-2008 CSIRO  
Copyright (c) 2007-2009 Xiph.Org Foundation  
Written by Jean-Marc Valin

Redistribution and use in source and binary forms, with or without modification, are permitted provided that the following conditions are met:

- Redistributions of source code must retain the above copyright notice, this list of conditions and the following disclaimer.
- Redistributions in binary form must reproduce the above copyright notice, this list of conditions and the following disclaimer in the documentation and/or other materials provided with the distribution.

THIS SOFTWARE IS PROVIDED BY THE COPYRIGHT HOLDERS AND CONTRIBUTORS ``AS IS'' AND ANY EXPRESS OR IMPLIED WARRANTIES, INCLUDING, BUT NOT LIMITED TO, THE IMPLIED WARRANTIES OF MERCHANTABILITY AND FITNESS FOR A PARTICULAR PURPOSE ARE DISCLAIMED. IN NO EVENT SHALL THE COPYRIGHT OWNER OR CONTRIBUTORS BE LIABLE FOR ANY DIRECT, INDIRECT, INCIDENTAL, SPECIAL, EXEMPLARY, OR CONSEQUENTIAL DAMAGES (INCLUDING, BUT NOT LIMITED TO, PROCUREMENT OF SUBSTITUTE GOODS OR SERVICES; LOSS OF USE, DATA, OR PROFITS; OR BUSINESS INTERRUPTION) HOWEVER CAUSED AND ON ANY THEORY OF LIABILITY, WHETHER IN CONTRACT, STRICT LIABILITY, OR TORT (INCLUDING NEGLIGENCE OR OTHERWISE) ARISING IN ANY WAY OUT OF THE USE OF THIS SOFTWARE, EVEN IF ADVISED OF THE POSSIBILITY OF SUCH DAMAGE.

Copyright (c) 2007-2008 CSIRO  
Copyright (c) 2007-2008 Xiph.Org Foundation  
Written by Jean-Marc Valin

Redistribution and use in source and binary forms, with or without modification, are permitted provided that the following conditions are met:

- Redistributions of source code must retain the above copyright notice, this list of conditions and the following disclaimer.

- Redistributions in binary form must reproduce the above copyright notice, this list of conditions and the following disclaimer in the documentation and/or other materials provided with the distribution.

THIS SOFTWARE IS PROVIDED BY THE COPYRIGHT HOLDERS AND CONTRIBUTORS ``AS IS'' AND ANY EXPRESS OR IMPLIED WARRANTIES, INCLUDING, BUT NOT LIMITED TO, THE IMPLIED WARRANTIES OF MERCHANTABILITY AND FITNESS FOR A PARTICULAR PURPOSE ARE DISCLAIMED. IN NO EVENT SHALL THE COPYRIGHT OWNER OR CONTRIBUTORS BE LIABLE FOR ANY DIRECT, INDIRECT, INCIDENTAL, SPECIAL, EXEMPLARY, OR CONSEQUENTIAL DAMAGES (INCLUDING, BUT NOT LIMITED TO, PROCUREMENT OF SUBSTITUTE GOODS OR SERVICES; LOSS OF USE, DATA, OR PROFITS; OR BUSINESS INTERRUPTION) HOWEVER CAUSED AND ON ANY THEORY OF LIABILITY, WHETHER IN CONTRACT, STRICT LIABILITY, OR TORT (INCLUDING NEGLIGENCE OR OTHERWISE) ARISING IN ANY WAY OUT OF THE USE OF THIS SOFTWARE, EVEN IF ADVISED OF THE POSSIBILITY OF SUCH DAMAGE.

Copyright (c) 2001-2008 Timothy B. Terriberry  
Copyright (c) 2008-2009 Xiph.Org Foundation

Redistribution and use in source and binary forms, with or without modification, are permitted provided that the following conditions are met:

- Redistributions of source code must retain the above copyright notice, this list of conditions and the following disclaimer.
- Redistributions in binary form must reproduce the above copyright notice, this list of conditions and the following disclaimer in the documentation and/or other materials provided with the distribution.

THIS SOFTWARE IS PROVIDED BY THE COPYRIGHT HOLDERS AND CONTRIBUTORS ``AS IS'' AND ANY EXPRESS OR IMPLIED WARRANTIES, INCLUDING, BUT NOT LIMITED TO, THE IMPLIED WARRANTIES OF MERCHANTABILITY AND FITNESS FOR A PARTICULAR PURPOSE ARE DISCLAIMED. IN NO EVENT SHALL THE COPYRIGHT OWNER OR CONTRIBUTORS BE LIABLE FOR ANY DIRECT, INDIRECT, INCIDENTAL, SPECIAL, EXEMPLARY, OR CONSEQUENTIAL DAMAGES (INCLUDING, BUT NOT LIMITED TO, PROCUREMENT OF SUBSTITUTE GOODS OR SERVICES; LOSS OF USE, DATA, OR PROFITS; OR BUSINESS INTERRUPTION) HOWEVER CAUSED AND ON ANY THEORY OF LIABILITY, WHETHER IN CONTRACT, STRICT LIABILITY, OR TORT (INCLUDING NEGLIGENCE OR OTHERWISE) ARISING IN ANY WAY OUT OF THE USE OF THIS SOFTWARE, EVEN IF ADVISED OF THE POSSIBILITY OF SUCH DAMAGE.

Copyright (c) 2010-2011 Xiph.Org Foundation, Skype Limited  
Written by Jean-Marc Valin and Koen Vos

Redistribution and use in source and binary forms, with or without modification, are permitted provided that the following conditions are met:

- Redistributions of source code must retain the above copyright notice, this list of conditions and the following disclaimer.
- Redistributions in binary form must reproduce the above copyright notice, this list of conditions and the following disclaimer in the documentation and/or other materials provided with the distribution.

THIS SOFTWARE IS PROVIDED BY THE COPYRIGHT HOLDERS AND CONTRIBUTORS ``AS IS'' AND ANY EXPRESS OR IMPLIED WARRANTIES, INCLUDING, BUT NOT LIMITED TO, THE IMPLIED WARRANTIES OF MERCHANTABILITY AND FITNESS FOR A PARTICULAR PURPOSE ARE DISCLAIMED. IN NO EVENT SHALL THE COPYRIGHT OWNER OR CONTRIBUTORS BE LIABLE FOR ANY DIRECT, INDIRECT, INCIDENTAL, SPECIAL, EXEMPLARY, OR CONSEQUENTIAL DAMAGES (INCLUDING, BUT NOT LIMITED TO, PROCUREMENT OF SUBSTITUTE GOODS OR SERVICES; LOSS OF USE, DATA, OR PROFITS; OR BUSINESS INTERRUPTION) HOWEVER CAUSED AND ON ANY THEORY OF LIABILITY, WHETHER IN CONTRACT, STRICT LIABILITY, OR TORT (INCLUDING NEGLIGENCE OR OTHERWISE) ARISING IN ANY WAY OUT OF THE USE OF THIS SOFTWARE, EVEN IF ADVISED OF THE POSSIBILITY OF SUCH DAMAGE.

Copyright (c) 2007-2008 CSIRO  
Copyright (c) 2007-2009 Xiph.Org Foundation  
Copyright (c) 2008 Gregory Maxwell  
Written by Jean-Marc Valin and Gregory Maxwell

Redistribution and use in source and binary forms, with or without modification, are permitted provided that the following conditions are met:

- Redistributions of source code must retain the above copyright notice, this list of conditions and the following disclaimer.
- Redistributions in binary form must reproduce the above copyright notice, this list of conditions and the following disclaimer in the documentation and/or other materials provided with the distribution.

THIS SOFTWARE IS PROVIDED BY THE COPYRIGHT HOLDERS AND CONTRIBUTORS ``AS IS'' AND ANY EXPRESS OR IMPLIED WARRANTIES, INCLUDING, BUT NOT LIMITED TO, THE IMPLIED WARRANTIES OF MERCHANTABILITY AND FITNESS FOR A PARTICULAR PURPOSE ARE DISCLAIMED. IN NO EVENT SHALL THE COPYRIGHT OWNER OR CONTRIBUTORS BE LIABLE FOR ANY DIRECT, INDIRECT, INCIDENTAL, SPECIAL, EXEMPLARY, OR CONSEQUENTIAL DAMAGES (INCLUDING, BUT NOT LIMITED TO, PROCUREMENT OF SUBSTITUTE GOODS OR SERVICES; LOSS OF USE, DATA, OR PROFITS; OR BUSINESS INTERRUPTION) HOWEVER CAUSED AND ON ANY THEORY OF LIABILITY, WHETHER IN CONTRACT, STRICT LIABILITY, OR TORT (INCLUDING NEGLIGENCE OR OTHERWISE) ARISING IN ANY WAY OUT OF THE USE OF THIS SOFTWARE, EVEN IF ADVISED OF THE POSSIBILITY OF SUCH DAMAGE.

Copyright (c) 2007-2008 CSIRO  
Copyright (c) 2007-2009 Xiph.Org Foundation  
Copyright (c) 2008-2012 Gregory Maxwell  
Written by Jean-Marc Valin and Gregory Maxwell

Redistribution and use in source and binary forms, with or without modification, are permitted provided that the following conditions are met:

- Redistributions of source code must retain the above copyright notice, this list of conditions and the following disclaimer.

- Redistributions in binary form must reproduce the above copyright notice, this list of conditions and the following disclaimer in the documentation and/or other materials provided with the distribution.

THIS SOFTWARE IS PROVIDED BY THE COPYRIGHT HOLDERS AND CONTRIBUTORS ``AS IS'' AND ANY EXPRESS OR IMPLIED WARRANTIES, INCLUDING, BUT NOT LIMITED TO, THE IMPLIED WARRANTIES OF MERCHANTABILITY AND FITNESS FOR A PARTICULAR PURPOSE ARE DISCLAIMED. IN NO EVENT SHALL THE COPYRIGHT OWNER OR CONTRIBUTORS BE LIABLE FOR ANY DIRECT, INDIRECT, INCIDENTAL, SPECIAL, EXEMPLARY, OR CONSEQUENTIAL DAMAGES (INCLUDING, BUT NOT LIMITED TO, PROCUREMENT OF SUBSTITUTE GOODS OR SERVICES; LOSS OF USE, DATA, OR PROFITS; OR BUSINESS INTERRUPTION) HOWEVER CAUSED AND ON ANY THEORY OF LIABILITY, WHETHER IN CONTRACT, STRICT LIABILITY, OR TORT (INCLUDING NEGLIGENCE OR OTHERWISE) ARISING IN ANY WAY OUT OF THE USE OF THIS SOFTWARE, EVEN IF ADVISED OF THE POSSIBILITY OF SUCH DAMAGE.

Copyright (c) 2012 Xiph.Org Foundation  
Written by Jean-Marc Valin

Redistribution and use in source and binary forms, with or without modification, are permitted provided that the following conditions are met:

- Redistributions of source code must retain the above copyright notice, this list of conditions and the following disclaimer.
- Redistributions in binary form must reproduce the above copyright notice, this list of conditions and the following disclaimer in the documentation and/or other materials provided with the distribution.

THIS SOFTWARE IS PROVIDED BY THE COPYRIGHT HOLDERS AND CONTRIBUTORS ``AS IS'' AND ANY EXPRESS OR IMPLIED WARRANTIES, INCLUDING, BUT NOT LIMITED TO, THE IMPLIED WARRANTIES OF MERCHANTABILITY AND FITNESS FOR A PARTICULAR PURPOSE ARE DISCLAIMED. IN NO EVENT SHALL THE COPYRIGHT OWNER OR CONTRIBUTORS BE LIABLE FOR ANY DIRECT, INDIRECT, INCIDENTAL, SPECIAL, EXEMPLARY, OR CONSEQUENTIAL DAMAGES (INCLUDING, BUT NOT LIMITED TO, PROCUREMENT OF SUBSTITUTE GOODS OR SERVICES; LOSS OF USE, DATA, OR PROFITS; OR BUSINESS INTERRUPTION) HOWEVER CAUSED AND ON ANY THEORY OF LIABILITY, WHETHER IN CONTRACT, STRICT LIABILITY, OR TORT (INCLUDING NEGLIGENCE OR OTHERWISE) ARISING IN ANY WAY OUT OF THE USE OF THIS SOFTWARE, EVEN IF ADVISED OF THE POSSIBILITY OF SUCH DAMAGE.

(C) COPYRIGHT 1994-2002 Xiph.Org Foundation  
Modified by Jean-Marc Valin

Redistribution and use in source and binary forms, with or without modification, are permitted provided that the following conditions are met:

- Redistributions of source code must retain the above copyright notice, this list of conditions and the following disclaimer.
- Redistributions in binary form must reproduce the above copyright notice, this list of conditions and the following disclaimer in the documentation and/or other materials provided with the distribution.

THIS SOFTWARE IS PROVIDED BY THE COPYRIGHT HOLDERS AND CONTRIBUTORS ``AS IS'' AND ANY EXPRESS OR IMPLIED WARRANTIES, INCLUDING, BUT NOT LIMITED TO, THE IMPLIED WARRANTIES OF MERCHANTABILITY AND FITNESS FOR A PARTICULAR PURPOSE ARE DISCLAIMED. IN NO EVENT SHALL THE COPYRIGHT OWNER OR CONTRIBUTORS BE LIABLE FOR ANY DIRECT, INDIRECT, INCIDENTAL, SPECIAL, EXEMPLARY, OR CONSEQUENTIAL DAMAGES (INCLUDING, BUT NOT LIMITED TO, PROCUREMENT OF SUBSTITUTE GOODS OR SERVICES; LOSS OF USE, DATA, OR PROFITS; OR BUSINESS INTERRUPTION) HOWEVER CAUSED AND ON ANY THEORY OF LIABILITY, WHETHER IN CONTRACT, STRICT LIABILITY, OR TORT (INCLUDING NEGLIGENCE OR OTHERWISE) ARISING IN ANY WAY OUT OF THE USE OF THIS SOFTWARE, EVEN IF ADVISED OF THE POSSIBILITY OF SUCH DAMAGE.

Copyright (C) 2007 Jean-Marc Valin

Redistribution and use in source and binary forms, with or without modification, are permitted provided that the following conditions are met:

1. Redistributions of source code must retain the above copyright notice, this list of conditions and the following disclaimer.
2. Redistributions in binary form must reproduce the above copyright notice, this list of conditions and the following disclaimer in the documentation and/or other materials provided with the distribution.

THIS SOFTWARE IS PROVIDED BY THE AUTHOR ``AS IS'' AND ANY EXPRESS OR IMPLIED WARRANTIES, INCLUDING, BUT NOT LIMITED TO, THE IMPLIED WARRANTIES OF MERCHANTABILITY AND FITNESS FOR A PARTICULAR PURPOSE ARE DISCLAIMED. IN NO EVENT SHALL THE AUTHOR BE LIABLE FOR ANY DIRECT, INDIRECT, INCIDENTAL, SPECIAL, EXEMPLARY, OR CONSEQUENTIAL DAMAGES (INCLUDING, BUT NOT LIMITED TO, PROCUREMENT OF SUBSTITUTE GOODS OR SERVICES; LOSS OF USE, DATA, OR PROFITS; OR BUSINESS INTERRUPTION) HOWEVER CAUSED AND ON ANY THEORY OF LIABILITY, WHETHER IN CONTRACT, STRICT LIABILITY, OR TORT (INCLUDING NEGLIGENCE OR OTHERWISE) ARISING IN ANY WAY OUT OF THE USE OF THIS SOFTWARE, EVEN IF ADVISED OF THE POSSIBILITY OF SUCH DAMAGE.

Copyright (c) 2007-2008 CSIRO

Copyright (c) 2007-2009 Xiph.Org Foundation

Written by Jean-Marc Valin

Redistribution and use in source and binary forms, with or without modification, are permitted provided that the following conditions are met:

- Redistributions of source code must retain the above copyright notice, this list of conditions and the following disclaimer.
- Redistributions in binary form must reproduce the above copyright notice, this list of conditions and the following disclaimer in the documentation and/or other materials provided with the distribution.

THIS SOFTWARE IS PROVIDED BY THE COPYRIGHT HOLDERS AND CONTRIBUTORS ``AS IS'' AND ANY EXPRESS OR IMPLIED WARRANTIES, INCLUDING, BUT NOT LIMITED TO, THE IMPLIED WARRANTIES OF MERCHANTABILITY AND FITNESS FOR A PARTICULAR PURPOSE

ARE DISCLAIMED. IN NO EVENT SHALL THE COPYRIGHT OWNER OR CONTRIBUTORS BE LIABLE FOR ANY DIRECT, INDIRECT, INCIDENTAL, SPECIAL, EXEMPLARY, OR CONSEQUENTIAL DAMAGES (INCLUDING, BUT NOT LIMITED TO, PROCUREMENT OF SUBSTITUTE GOODS OR SERVICES; LOSS OF USE, DATA, OR PROFITS; OR BUSINESS INTERRUPTION) HOWEVER CAUSED AND ON ANY THEORY OF LIABILITY, WHETHER IN CONTRACT, STRICT LIABILITY, OR TORT (INCLUDING NEGLIGENCE OR OTHERWISE) ARISING IN ANY WAY OUT OF THE USE OF THIS SOFTWARE, EVEN IF ADVISED OF THE POSSIBILITY OF SUCH DAMAGE.

Copyright (C) 2002-2003 Jean-Marc Valin  
Copyright (C) 2007-2009 Xiph.Org Foundation

Redistribution and use in source and binary forms, with or without modification, are permitted provided that the following conditions are met:

- Redistributions of source code must retain the above copyright notice, this list of conditions and the following disclaimer.
- Redistributions in binary form must reproduce the above copyright notice, this list of conditions and the following disclaimer in the documentation and/or other materials provided with the distribution.

THIS SOFTWARE IS PROVIDED BY THE COPYRIGHT HOLDERS AND CONTRIBUTORS ``AS IS'' AND ANY EXPRESS OR IMPLIED WARRANTIES, INCLUDING, BUT NOT LIMITED TO, THE IMPLIED WARRANTIES OF MERCHANTABILITY AND FITNESS FOR A PARTICULAR PURPOSE ARE DISCLAIMED. IN NO EVENT SHALL THE COPYRIGHT OWNER OR CONTRIBUTORS BE LIABLE FOR ANY DIRECT, INDIRECT, INCIDENTAL, SPECIAL, EXEMPLARY, OR CONSEQUENTIAL DAMAGES (INCLUDING, BUT NOT LIMITED TO, PROCUREMENT OF SUBSTITUTE GOODS OR SERVICES; LOSS OF USE, DATA, OR PROFITS; OR BUSINESS INTERRUPTION) HOWEVER CAUSED AND ON ANY THEORY OF LIABILITY, WHETHER IN CONTRACT, STRICT LIABILITY, OR TORT (INCLUDING NEGLIGENCE OR OTHERWISE) ARISING IN ANY WAY OUT OF THE USE OF THIS SOFTWARE, EVEN IF ADVISED OF THE POSSIBILITY OF SUCH DAMAGE.

## 10.6

### Notices

#### Copyright and disclaimer

All rights reserved. No part of this document may be reproduced or transmitted in any form by any means, electronic, mechanical, photocopying, recording, or otherwise, without the prior written permission of the publisher. For information on getting permission for reprints and excerpts, contact Electro-Voice.

All content including specifications, data, and illustrations in this manual are subject to change without prior notice.

#### Bluetooth®



#### Notice!

Bluetooth® is available in selected countries.

Contact your nearest Electro-Voice dealer or Electro-Voice distributor for more information.

The Bluetooth® word mark and logos are registered trademarks owned by Bluetooth SIG, Inc. and any use of such marks by Bosch Security Systems, LLC is under license. Other trademarks and trade names are those of their respective owners.

**Importer and after-sales service****China**

Bosch (Shanghai) Security Systems Ltd.  
333 Fuquan Road North IBP  
Changning District Shanghai  
200335 P.R. China

博世（上海）安保系统有限公司  
上海市长宁区虹桥临空经济园区，福泉北路333号

**EU**

Bosch Sicherheitssysteme GmbH  
Robert-Bosch-Platz 1  
70839 Gerlingen  
Germany

**Mexico**

Robert Bosch de R.L de C.V.  
Calle Robert Bosch No. Ext. 405  
C.P.50071  
Zona industrial Toluca  
Mexico  
Phone: +52 722 279 2300

**UK**

Robert Bosch Ltd.  
Broadwater Park  
North Orbital Road  
Uxbridge UB9 5HJ  
UK

**Notice!**

To report security vulnerability use this link: <https://psirt.bosch.com/report-a-vulnerability/>

---

**Warranty**

For information on warranty periods and after sales service, please visit:  
[www.electrovoice.com/warranty](http://www.electrovoice.com/warranty)

本表系根据SJ/T 11364-2024的规定编制而成  
 针对在中国境内使用：China RoHS 信息表  
 扬声器

产品中有害物质的名称及含有信息表										
部件名称	有害物质									
	Pb 铅	Hg 汞	Cd 镉	Cr(VI) 六价铬	PBB 多溴联苯	PBDE 多溴二苯 醚	DEHP 邻苯二甲 酸二(2-乙 基)己酯	BBP 邻苯二甲 酸丁基苯 酯	DBP 邻苯二甲 酸二正丁 酯	DIBP 邻苯二甲 酸二异丁 酯
金属部件	X	○	○	○	○	○	○	○	○	○
塑胶部件	○	○	○	○	○	○	○	○	○	○
外壳	○	○	○	○	○	○	○	○	○	○
电子元件-LED元件	X	○	○	○	○	○	○	○	○	○
电子元件-印制电路 板	X	○	○	○	○	○	○	○	○	○
电缆和电缆配件	○	○	○	○	○	○	○	○	○	○

注 1：○：表示该有害物质在该部件所有均质材料中的含量均不超出电器电子产品有害物质限制使用国家标准要求。  
 X：表示该有害物质至少在该部件的某一均质材料中的含量超出电器电子产品有害物质限制使用国家标准要求。  
 注 2：以上未列出的部件，表明其有害物质含量均不超出电器电子产品有害物质限制使用国家标准要求。  
 关于该类产品生产日期代码的详细说明，请见：<http://www.boschsecurity.com/datecodes/>

 本标识内数字表示产品在正常使用状态下的环保使用期限为 10 年

QA PASS 合格证  
 博世安防系统

**Disposal**

For use in France: Sorting Info label (Info-tri)











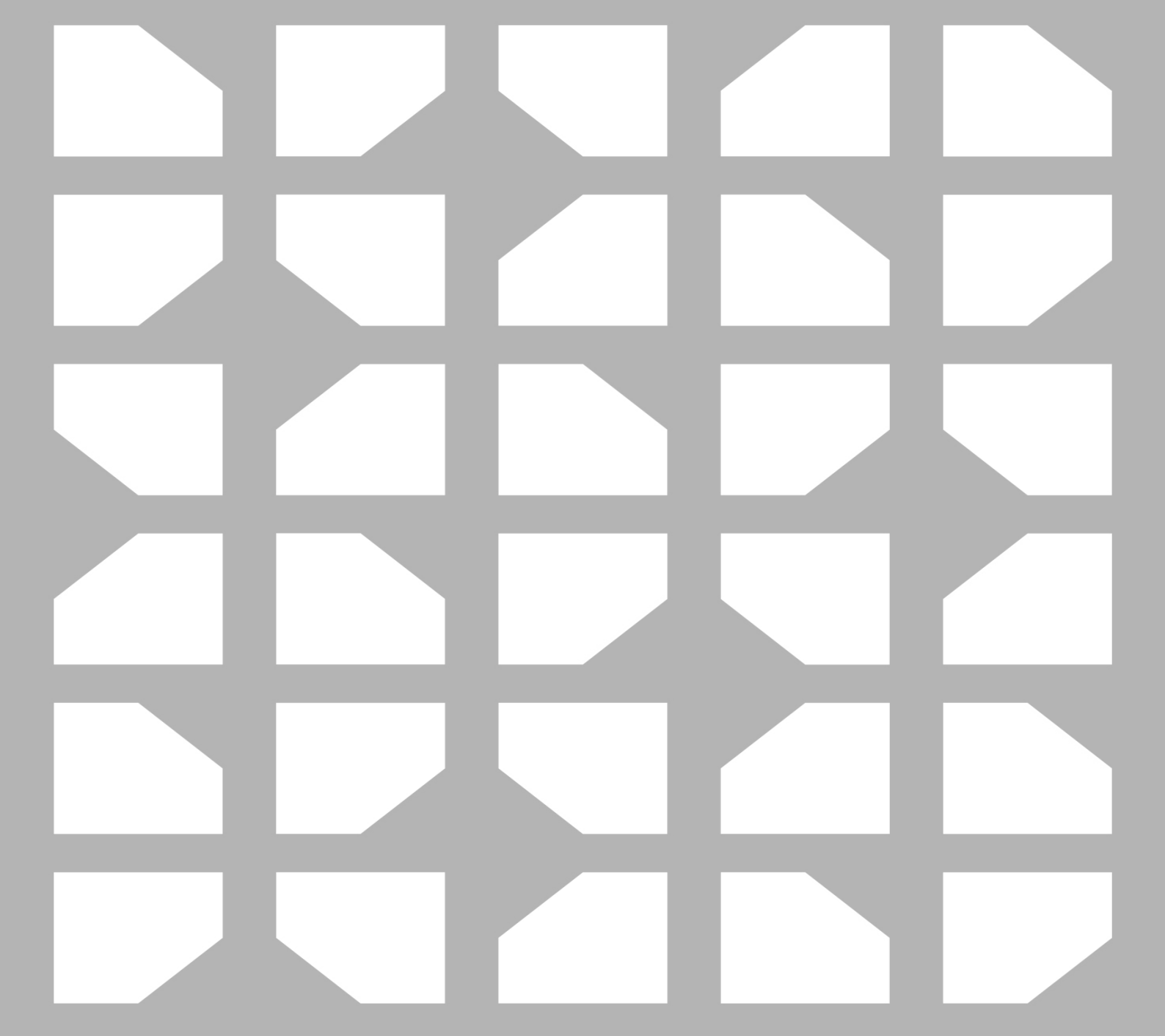

**Bosch Security Systems, LLC**

130 Perinton Parkway  
Fairport, NY 14450  
USA

**[www.electrovoice.com](http://www.electrovoice.com)**

© Bosch Security Systems, LLC, 2025

**EU importer:**

**Bosch Sicherheitssysteme GmbH**

Robert-Bosch-Platz 1  
70839 Gerlingen  
Germany

© Bosch Sicherheitssysteme GmbH, 2025  
202505221536